



M.T.H. HO GP 35 Diesel Engine

DCC Ready
ENGINEER'S GUIDE

Congratulations! You've just purchased the most technically advanced HO diesel locomotive ever produced! This highly detailed model includes a broader range of features than you'll find on any other HO scale diesel, including smooth performance from a 12-Volt 5-Pole Precision Flywheel Equipped Skew-wound motor; and a DCC-Ready plug-in receptacle for any DCC receiver. If you're looking for modern motive power that's accurately detailed, smooth running, and a great deal of fun to operate, it doesn't get any better than this.

**PLEASE READ THE MANUAL BEFORE USE AND
SAVE**

TABLE OF CONTENTS

UNPACKING YOUR ENGINE	3
Removing and Unwrapping Your Engine	3
What Else is in the Box?	3
QUICK START GUIDE	4
PRODUCT OVERVIEW	5
Getting to Know Your Engine	5
Engine Diagram	6
Removing the Body	6
SET-UP	8
Lubrication	8
FEATURES AND OPERATION	9
Analog DC (standard DC power pack)	9
DCC Digital Command Control	9
Alternate Lighting Supply Jumper	10
Installing your DCC Decoder	11
SPECIFICATIONS	13
CARE AND MAINTENANCE	14
Troubleshooting Guide	14
HOW TO ORDER PARTS	15
SERVICE & WARRANTY INFORMATION	16
Service & Warranty Information	16
Limited One-Year Warranty	16

CAUTION: ELECTRICALLY OPERATED PRODUCT:

Recommended for Ages 14 and up. Not recommended for children under 14 years of age without adult supervision. As with all electric products, precautions should be observed during handling and use to prevent electric shock.

WARNING: When using electrical products, basic safety precautions should be observed, including the following:
Read this manual thoroughly before using this device.

- M.T.H. recommends that all users and persons supervising use examine the hobby transformer and other electronic equipment periodically for conditions that may result in the risk of fire, electric shock, or injury to persons, such as damage to the primary cord, plug blades, housing, output jacks or other parts. In the event such conditions exist, the train set should not be used until properly repaired.
- Do not operate your layout unattended. Obstructed accessories or stalled trains may overheat, resulting in damage to your layout.
- This train set is intended for indoor use. Do not use if water is present. Serious injury or fatality may result.
- Do not operate the hobby transformer with damaged cord, plug, switches, buttons or case.

This product may be protected by one or more of the following patents: 6,019,289; 6,280,278; 6,281,606; 6,291,263; 6,457,681; 6,491,263; 6,604,641; 6,619,594; 6,624,537; 6,655,640.

REV_80dl12522i_Gp35 1/31/2013

UNPACKING YOUR ENGINE

Removing and Unwrapping Your Engine

Carefully remove and unwrap the model on a soft surface. By nature, models with high levels of detail have some small fragile parts.

Carefully remove any foam packing pieces that may be surrounding the model.

What Else is in the Box?

The following items are packed with your engine.

Engineer's Guide (1)

You probably know that since you're reading it.

ALT-L Pad Jumper (1)

This is for the ALT-L pad on the MTH DCC Ready Engine Board

QUICK START GUIDE

Of course, you should read your manual over before running your engine, but if you just can't wait you're in luck. Your MTH DCC Ready engine is ready to run out of the box. Follow the three simple steps below to get your new engine up and running. Now, after a few minutes, shut her down and read through your engineer's guide.

I USE A REGULAR DC SUPPLY...

Step 1: Unpack your Engine. (refer to unpacking instruction on pg 4)...

Step 2: Set the engine on the track ...

Step 3: Apply increasing **DC** voltage until she starts up and pulls out!

CAUTION: M.T.H. HO engines ***DO NOT OPERATE ON AC VOLTAGE***. Applying AC power to your locomotive could cause permanent damage and will void your warranty.

PRODUCT OVERVIEW

Getting to Know Your M.T.H. HO Locomotive

Key Features

Your new HO Diesel Engine is equipped with a DCC-Ready receiver receptacle. In plain English, this means your locomotive is ready-to-run using any DC power supply and can be quickly updated to command control with any DCC decoder. This HO model has a directional Headlight and Mars light (by default) and has locations for DCC decoders to drive the Number Board/Classification, Interior, and Mars light (separate from the Headlight).

Compatibility

Compatible with any DC power supply

Compatible with DCC decoders that use the standard 8-pin NMRA connection

Lights

As you read on, you'll notice there are no instructions for replacing light bulbs in your diesel. That's because there aren't any. We use specially designed and controlled LEDs to create realistic lighting effects that occur automatically. All the lights for this model are LED'S. Again, NO PROGRAMMING!!

More...

No other HO locomotive has features like these. There are so many more things to learn and enjoy about M.T.H. HO Engines, we could write a book. But, that's no fun. So, if you haven't already done so, flip to the Quick Start Guide and let's run your new engine!!

ENGINE DIAGRAM

Locomotive

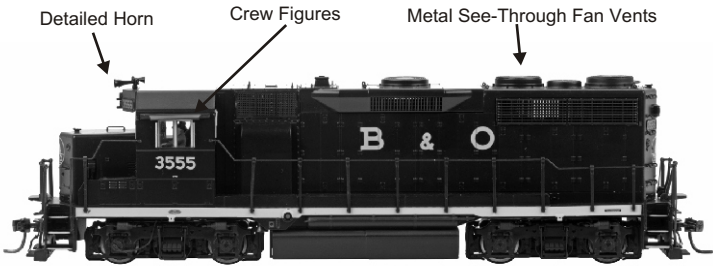

Removing the Body

Follow the below steps to remove the body and access the DCC ready control tabs.

The first step is to remove the couplers. After couplers have been removed, the body can be removed from the chassis (Follow directions below).



1. To remove the couplers, use a phillips head screwdriver to remove the screws

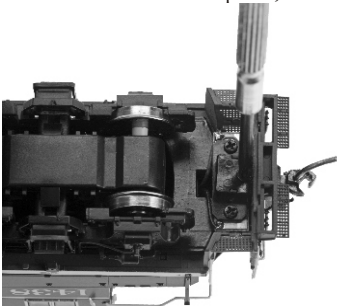

2. Once the screws are removed, you can pull away the coupler. You will have to pull the coupler through the pilot.

3. Remove spacers

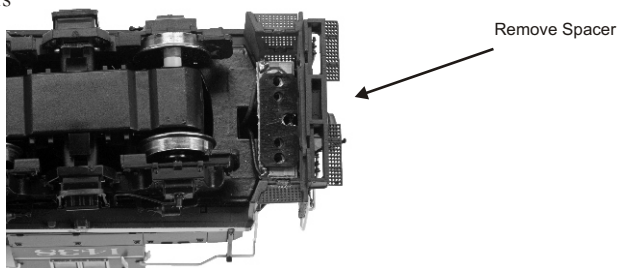

4. Now that you have the couplers removed, use both hands to slightly bend the body outward (using the tabs covering the fuel tanks) and gently lift the body away from the chassis

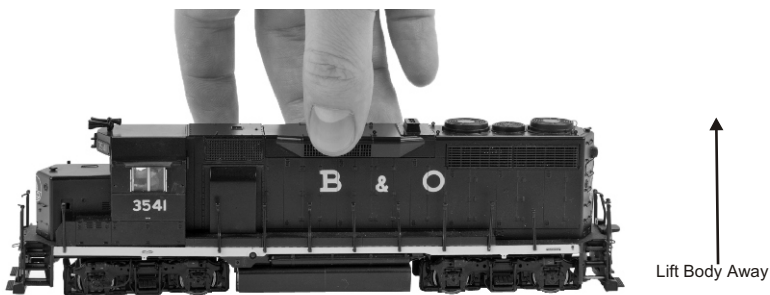

The chassis is now accessible.

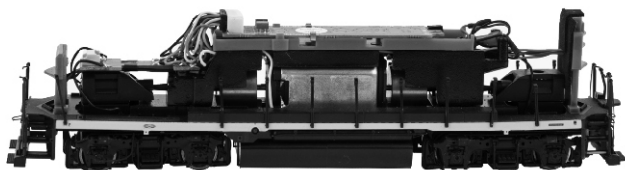

To re-install the body:

1. Slide the body over the chassis taking care not to catch it on the any parts.
2. Press down evenly on the front and rear of the top of the body to engage the clips onto the chassis
3. If you have the body clipped to the chassis correctly you should be able to pick the model up by the body

SET-UP

Lubrication

Using light machine or household oil, apply a very small amount to all axles points as shown.

Your gearbox is properly greased at the factory and probably never needs service however, if you run excessive hours pulling heavy loads, it's a good idea to remove the 2 screws from the gearbox cover and re-grease using M.T.H. gear grease or equivalent.



Couplers

MTH DCC Ready engine comes with Kadee © couplers already installed.

FEATURES AND OPERATION

Conventional Operation Jumpers

Your MTH DCC Ready engine has pre-installed jumpers that allow for out-of-the-box operation. However, you can remove these jumpers to change the lighting to your liking. You can shut off the Number Board/classification Lights by removing the jumpers on the engine's circuit board. Please refer to Removing Jumpers in the DCC Operation section of this manual.

It is important to note that there two sets of jumpers that route track power to your engine's motor. These must be installed when operating in Conventional DC mode.

Don't worry. We've taken care of the hard part for you. Your MTH DCC Ready engine already has the jumpers installed at the factory so all you have to do is set it on the rails, apply DC power and away you go.

FEATURES AND OPERATION

Modes of Operation

Analog DC

This is when there is nothing connected to the rails except a conventional DC power pack. These power packs generally have at least one variable output controlled by a throttle of some sort and a means of reversing DC polarity on the track to change the direction of your engine.

DCC

The user connects their DCC decoder of choice to the MTH DCC Ready board's 8-pin header following the DCC decoder's manufacturer's instructions.

Analog DC

Not much explanation is required here, and that's exactly why you run your trains this way! Here's the good news, even if you like to keep it simple, your MTH HO engine is outfitted with lights, features, that you're going to love.

Running the Engine

Set the engine on the rails, and apply DC power. Refer to the Set-Up section of this guide for instructions on how to lubricate the chassis.

As you increase power, at about 3 volts, the lights will come on and she'll move out! Continue increasing the voltage all the way to 16 volts DC for maximum speed.

Changing Direction

Reduce the throttle until the engine stops, flip the direction switch, and then increase the throttle again.

Lighting

Your model is equipped with a headlight and number board lights. In analog DC mode, lighting operation is fully automatic.

Alternate Lighting Supply Jumper

This exists on your MTH board in case you have a DCC decoder that doesn't have an appropriate lighting supply line. Most all current DCC decoders have a lighting supply line so in most cases you won't need this jumper installed. If you have programmed your DCC decoder correctly and you still have no lights then you will need to install this jumper. Again, this is why it is recommended that you operate the model with the body off after installation of any DCC decoder.

DCC Lighting Control Tabs

These tabs provide wiring locations for DCC Decoders that have extra F functions available. The tabs are labeled on the board – D_R = Interior Light, D_L = Mars Light (the light over the Headlight), NUM = Green Classification

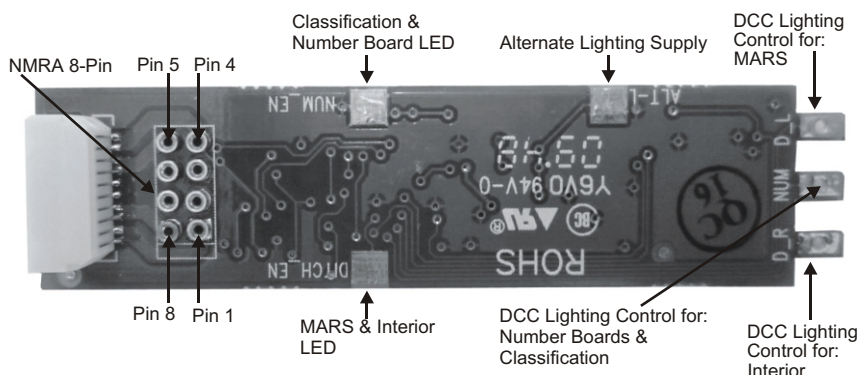

To install your DCC decoder:

Step 1: Remove the engine's body and couplers. See Pages 6 & 7.

Step 2: Remove the two jumpers in the 8-pin NMRA header and Alternate Lighting Supply jumper on the side of the board (it's removed out of the box already).

- Classification/Number Board
- Alternate Lighting Supply
- NMRA Header (both jumpers)

Step 3: Connect your DCC decoder to the 8-pin NMRA header on your MTH engine board. Follow your DCC decoder's manufacturer's instructions carefully

NOTE - If your DCC decoder has the extra F - Functions (and wires) available you can connect the DCC decoder board to the 3 tabs at the end of the MTH DCC-Ready board to control the Interior, the Mars, and the Classification/Number Boards.

If your DCC decoder has only a headlight and a taillight available and you want to keep your Number Board/Classification lights active, leave the pad jumpers installed for Number Board/Classification on your MTH board. The tabs on the end of the MTH board are available for you to wire your DCC Decoder's function control lines to them to allow control of the Number Board/Classification lights. For example, if you want your DCC Decoder to control the Number Board/Classification lights and you have the function control line to do so, remove the Number Board/Classification pad jumper then wire the control line from your DCC Decoder to the NUM pad on the MTH board.

To mount your DCC Decoder to the MTH board it is recommended that you use double-sided tape and ensure your DCC decoder board doesn't touch your MTH board (keep the two boards insulated from one another). There is quite a bit of room available inside your model so for most DCC decoders you will find it easy to mount them

Step 4: If you are connecting the extra lighting function wires from the note above then simply slide the plastic wire clip off the tab on the MTH board and insert the wire then slide the clip back on. This provides a secure, yet, quick and easy way to connect the added function wires from your DCC decoder using the existing LED's on your MTH engine.

If you are adding a 28mm speaker and want to utilize one or more of the existing cut-outs in your MTH engine's fuel tank you will most likely need to desolder the wires from the speaker in order to get them fished down through the model. To continue please go to Step 5:

Step 5-9: Some models have areas to accommodate a speaker; some do not. Please review the model when you have the body removed to see if you can fit one into it. Additionally, some models' fuel tanks can accommodate speaker and others may have an area specifically for a round, 28mm speaker inside the body. **DO NOT** place a speaker directly onto the MTH DCC-Ready circuit board as a short circuit may occur. Also, if you are installing a speaker ensure the speaker leads do not touch the chassis, you will likely damage your DCC decoder and/or the MTH DCC-Ready board.



Bottom of the Fuel Tank

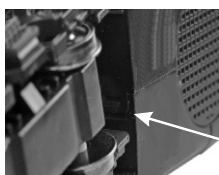

(Pry open the two latches on both sides of the Fuel Tank to open up the bezel)

Latch



Bezels



Once the latches are open, remove the bezels to expose the speaker enclosure



Closed Speaker Enclosure



Open Speaker Enclosure

Step 10: Place the engine back on the track with the engine's body still removed

Step 11: Apply DCC power to the rails and follow your DCC decoder's manufacturer's instruction for operation. You want to ensure you have the wiring correct and not shorting to anything on the chassis or the MTH board. This is particularly true if you have wired in a speaker and ran the speaker wires from the fuel tank up past the motor

If you have successful operation of your DCC decoder then you can proceed to the next step:

Step 12: Re-install the engine's body and ensure that it is clipped fully onto the chassis. You should be able to pick up your model by the body if it's been installed properly

Step 13: Re-install the couplers.

SPECIFICATIONS

Electrical	Input Voltage	0 - 18 VDC
	Current Draw (lights, sounds)	~100 – 300 mA unloaded)
	Lighting	LED - Rule 17
Operating Modes	Analog DC	Yes
	DCC - Digital Command Control (with user installed DCC Decoder)	Yes
	DCS - Digital Control System	No
Default Addresses	DCS	N/A
	DCC short	N/A
	DCC extended	N/A

US PATENTS

US 6,457,681	Oct. 2, 2002
US 6,619,594	Sept. 16, 2003
US 6,655,640	Dec. 2, 2003

CARE AND MAINTENANCE

HO Troubleshooting Guide

The following Guide will help you trouble shoot your M.T.H. HO engine.

Analog DC

Start-Up	Solution
When I apply power to the track my engine doesn't do anything. No lights, no movement.	Check to see if that section of track has power. Use a voltmeter or a lit passenger car.
	Slide the engine a couple of feet in either direction, you may have a bad track section.
	Have you got that section electrically isolated with a toggle switch or other device?

Lights	Solution
No Number Board lights are on.	Check that the appropriate jumpers are installed. Remember - the jumpers must be installed in Analog DC for the Number Board lights to be active.
Motion	Solution
No movement of the engine when track power is applied.	Check that the NMRA header jumpers are installed. You must jump pin 1 to pin 8 and also pin 4 to pin 5.

Lights	Solution
The Number Board lights are not controllable from DCC	Check that you have removed the jumpers for the Number Board lights.
Motion	Solution
Motor spins at track voltage	Check that you have removed the NMRA header jumper (both jumpers)

HOW TO ORDER PARTS:

Replacement parts are available directly from the M.T.H. Parts Department (Order online: www.mthtrains.com, e-mail: parts@mth-railking.com, Fax: 410-423-0009, Phone: 410-381-2580, Mail: 7020 Columbia Gateway Drive, Columbia MD 21046-1532,).

Service & Warranty Information

How to Get Service Under the Terms of the Limited One-Year Warranty

When you suspect an item is defective, please check the operator's manual for standard operation and trouble-shooting techniques that may correct the problem. Additional information may be found on the M.T.H. Website. Should you still require service, follow the instructions below to obtain warranty service. First, e-mail, write, call or fax a M.T.H. Authorized Service Center (ASC) in your area to obtain Repair Authorization. You can find the list of ASCs on the M.T.H. Website, www.mthtrains.com. Authorized Service Centers are required to make warranty repairs on items sold only from that store; all other repairs may-- or may not be done at the store's own discretion. If you did not purchase the item directly from the ASC, you will need to select a National Authorized Service Center (NASC). These centers are compensated by M.T.H. to perform warranty service for any customer whose repair qualifies for warranty service. A list of NASC retailers can be located on the M.T.H. Website or by calling 410-381-2580. Should the warranty no longer apply, you may choose either an ASC or NASC retailer to service your M.T.H. Product. A reasonable service fee will be charged.

CAUTION: Make sure the product is packed in its original factory packaging including its foam and plastic wrapping material to prevent damage to the merchandise. There is no need to return the entire set if only one of the components is in need of repair unless otherwise instructed by the Service Center. The shipment must be prepaid and we recommend that it be insured. A cover letter including your name, address, daytime phone number, e-mail address (if available), Return Authorization number (if required by the service center, a copy of your sales receipt and a full description of the problem must be included to facilitate the repairs. Please include the description regardless of whether you discussed the problem with a service technician when contacting the Service Center for your Return Authorization.

Please make sure you have followed the instructions carefully before returning any merchandise for service. Authorized M.T.H. Service Centers are independently owned and operated and are not agents or representatives of M.T.H. Electric Trains. M.T.H. assumes no responsibility, financial or otherwise, for material left in their possession, or work done, by privately owned M.T.H. Authorized Service Centers.

If you need assistance at any time email MTH Service at service@mth-railking.com, or call 410 381-2580.

Limited One-Year Warranty

All M.T.H. products purchased from an M.T.H. Authorized Retailer are covered by this warranty provided the product was manufactured within five years of the date of purchase. This warranty is for the original purchaser and is non-transferable.

See our website www.mthtrains.com to identify an M.T.H. Authorized Retailer near you.

M.T.H. products may be registered online in advance of warranty work at www.mthtrains.com/warranty. The original sales receipt and the conditions below must be met regardless of whether the product is registered on the M.T.H. website in order to obtain warranty service.

M.T.H. products manufactured within five years from the date of purchase are warranted for one year against defects in material or workmanship, excluding wear items such as light bulbs, pick-up rollers, batteries, smoke unit wicks, and traction tires. We will repair, replace, or credit (at our option) the defective part without charge for the parts or labor if the following conditions are met: (1) the item is returned to an M.T.H. Authorized Service Center* (ASC) or M.T.H. National Authorized Service Center (NASC) or M.T.H. Electric Trains Service Department, (2) was manufactured within the previous five years and (3) was purchased within one year of the original date of purchase from an M.T.H. Authorized Retailer. Products manufactured after the five year cutoff from the date of purchase are not covered under any warranty by M.T.H. Electric Trains. The manufacture date of an item can be verified on the item's detail page "shipping date field" on the M.T.H. website (www.mthtrains.com). This warranty does not cover damages caused by improper care, handling, or use. Transportation costs incurred by the customer are not covered under this warranty.

Items sent for repair must be accompanied by a return authorization number, a description of the problem, and a **copy of the original sales receipt from an M.T.H. Authorized Retailer**, which gives the date of purchase. If you are sending this product to an Authorized Service Center, contact that Center for their return authorization.

This warranty gives you specific legal rights, and you may have other rights that vary from state to state. Specific questions regarding the warranty may be forwarded to M.T.H. Directly.

* Authorized Service Centers (ASC) are only obligated to provide warranty service for any consumer who has purchased the specific M.T.H. item from them that requires service work.

Service Department:
M.T.H. Electric Trains
7020 Columbia Gateway Drive
Columbia MD 21046-1532