



4-6-4 J3a Hudson Steam Locomotive

OPERATOR'S MANUAL



Compatibility

This locomotive is capable of operating on AC or DC output power supplies (See page 25 for a complete list of compatible transformers and wiring instructions.) and indoors or outdoors. MTH does not recommend operating the locomotive in inclement weather and strongly suggests that it not be left out in the elements. The locomotive will negotiate an R2 G-Gauge curve track or switch. Additional features may be utilized when controlling the engine with MTH's Digital Command System (DCS).



PLEASE READ BEFORE USE AND SAVE

Table of Contents

Set Up Checklist	3
Tender Coupler Installation.....	3
Lubrication.....	4
Priming The Smoke Unit.....	4
Checking The Battery.....	5
Placing The Engine On The Track.....	6
Basic Operation	7
Activating Features.....	8
Proto-Sound 2.0 Operating Instructions	10
Activating Proto-Sound 2.0 Conventional Mode Features.....	10
Freight Yard Sounds (FYS).....	11
Speed Control.....	13
Locking Locomotive Into A Direction.....	14
Reset To Factory Default.....	14
Automatic Sound Effects.....	14
Maintenance	15
Lubricating and Greasing Instructions.....	15
Traction Tire Replacement Instructions.....	17
Light Bulb Replacement Instructions.....	18
Self Charging Battery Back-Up.....	19
ProtoSmoke® Unit Operation.....	20
Troubleshooting Proto-Sound® 2.0 Problems.....	22
Transformer Compatibility and Wiring Chart.....	25
Additional Features Accessible With The DCS System.....	26
Service & Warranty Information.....	27
Limited One-Year Warranty.....	27
Participating Retailer List.....	28

CAUTION: ELECTRICALLY OPERATED PRODUCT:

Not recommended for children under 10 years of age. M.T.H. recommends adult supervision with children ages 10 - 16. As with all electric products, precautions should be observed during handling and use to reduce the risk of electric shock.

WARNING: When using electrical products, basic safety precautions should be observed, including the following: Read this manual thoroughly before using this device.

- M.T.H. recommends that all users and persons supervising use examine the hobby transformer and other electronic equipment periodically for conditions that may result in the risk of fire, electric shock, or injury to persons, such as damage to the primary cord, plug blades, housing, output jacks or other parts. In the event such conditions exist, the train set should not be used until properly repaired.
- Do not operate your layout unattended. Obstructed accessories or stalled trains may overheat, resulting in damage to your layout.
- This train set is intended for indoor or outdoor use. Do not use if water is present. Serious injury or fatality may result.
- Do not operate the hobby transformer with damaged cord, plug, switches, buttons or case.

Set Up Checklist

- Install the tender coupler
- Lubricate the locomotive
- Prime the smoke unit
- Check to see whether the batteries need to be charged for full sound effects
- Apply power to run as described in the Basic Operating Section of this manual

Installing The Tender Coupler

This RailKing One-Gauge locomotive can be equipped with three different types of G-Gauge couplers - an MTH knuckle coupler, an MTH hook & loop coupler or a 1/32nd Kadee coupler. For your convenience, the MTH knuckle and the hook & loop couplers have been included with your locomotive. The Kadee type must be the 1/32nd size and can be purchased from a Kadee coupler retailer. Prior to installation, you will need to install the Kadee coupler base included inside your locomotive's packaging.

Both the standard knuckle and the hook and loop coupler designs attach to the tender trailing truck in the same manner as seen in Figures 2 and 3.

Knuckle Coupler
In Standard Factory Position "A"



Figure 2: Knuckle Coupler Position "A"

Hook & Loop Coupler



Figure 3

Installing The Tender Coupler (cont'd)

If the locomotive is to be mated up with a different scaled G-Gauge locomotive, freight or passenger car, the knuckle coupler assembly may need to be relocated on the coupler armature as seen in Fig. 4. The second lower location or position “B” is on the bottom of the armature extending from the truck rather than the default top position “A” which is on top of the armature. Simply unscrew the coupler shaft from the armature, separate the coupler knuckle (attached by screw & nut) from this shaft and relocate to the bottom of the shaft. Reassemble.

Note: When the standard knuckle coupler is installed in position B, the knuckle pin must be cut off as shown in Fig. 4. The coupler pin has been “scored” so that it can be easily cut off with a pair of snippers.

The Hook and Loop coupler mounts to the truck armature in the same manner as the Knuckle Coupler. Note that the mounting screw is located behind the rear axle as seen in Figure 5.

If a Kadee Coupler is to be installed, remove the MTH knuckle or hook & loop coupler and install the Kadee Coupler base included in your locomotive packaging as seen in Figure 5a. Once the coupler base is installed, attach the Kadee Coupler onto the mount (See Fig. 5b) by following the Kadee Coupler’s installation guide.

Standard Knuckle Coupler In Position “B”

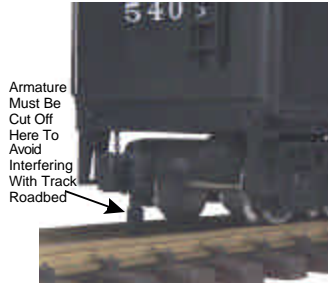

Figure 4

Hook and Loop and Knuckle Couplers Attach To Truck Armature Via This Mounting Screw

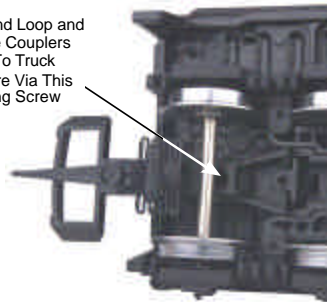

Figure 5

Install Kadee Coupler Mount into mounting holes on tender chassis



Figure 5a

Install Kadee Coupler Onto Coupler Mount Using Kadee supplied screws



Figure 5b

Lubrication



You should lubricate the engine to prevent it from squeaking. Use light household oil and follow the lubrication points marked “L” in Fig. 6. Do not over-oil. Use only a drop or two on each pivot point.

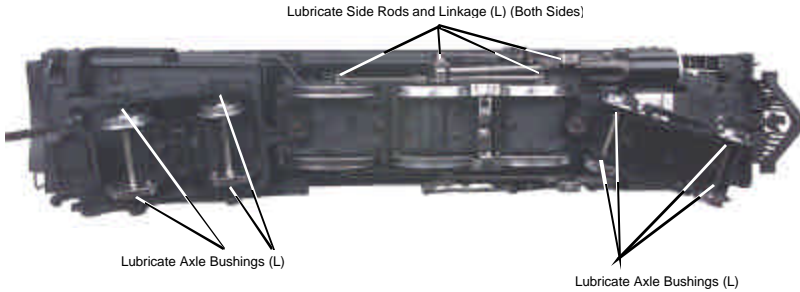

Figure 6. Lubrication Points on the Locomotive

Priming The Smoke Unit

When preparing to run this engine, add 30-40 drops of smoke fluid through the smokestack. We recommend M.T.H. ProtoSmoke, Seuthe, LGB, or LVTS fluids. Do not overfill the unit or the fluid may leak out and coat the interior engine components.

If you choose not to add the fluid (or have already added the fluid but choose to run smoke-free), rotate the smoke unit knob located inside the boiler front (see Fig. 7) to the off position (rotate clockwise). If you wish to regulate the smoke output intensity, turn the knob between full counterclockwise and full clockwise until the desired smoke output is reached.

Failure either to add fluid to the unit or to turn it off may damage the smoke unit heating element and/or wicking material.

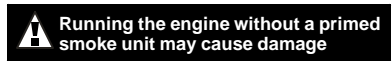

Figure 7: Smoke Unit Switch Location

While MTH does not recommend operating outdoors in inclement weather (in order to prevent possible damage to the electronics), we have included for your convenience, a smoke stack “cap” inside your locomotive packaging. This cap should be inserted on the smoke stack to prevent moisture from entering the smoke unit chamber.

Placing The Engine On The Track

Place the engine on the track, then insert the reverse unit plug that extends out of the tender into the receptacle at the back of the boiler cab (Figure 8. **WARNING: DO NOT CONNECT THIS ENGINE TO A TENDER FROM ANOTHER ENGINE; IT MAY CAUSE SERIOUS DAMAGE.**

Connect the draw bar between the engine and tender.

At this point, you are ready to begin running your engine.

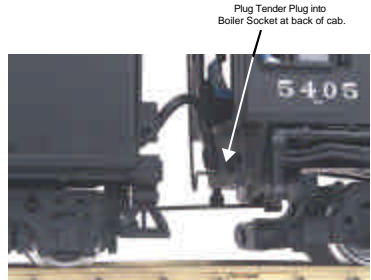

Figure 8: Connecting Tender Harness

Checking The Battery

You may find, if your locomotive was built several months before you set it up, that the rechargeable batteries have run down and need to be charged before operating. If you notice that the sounds are garbled, test and charge the engine as described in the "Self-Charging Battery Back-Up" on page 19.

Basic Operation

RailKing One-Gauge locomotives can be operated with AC or DC power output transformers. When using DC output power supplies, the user can only control the locomotive speed and direction. The locomotive will still make engine sounds but no bell or whistle control is possible when using a DC output power supply unless the user wishes to hook up the power supply to MTH's separately sold Digital Command System (see below).

As with all G-Gauge locomotives, the Throttle knob or handle controls how fast your train will travel.

Activating Features Using DC Power

Throttle To increase or decrease track voltage, and therefore train speed, turn or slide the throttle control knob. Turning clockwise will increase voltage and speed, while turning counterclockwise will decrease voltage and speed. Because your RailKing One-Gauge locomotive is equipped with MTH's Speed Control feature, the engine will maintain the speed you set after you release the throttle until you turn it again to change the voltage and speed. This feature works very similarly to a cruise control system found in automobiles and allows the engine to maintain its speed even as it enters curves, traverses grades or coasts down inclines.

Direction - To change locomotive direction, slow the engine down using the throttle knob until the engine comes to a complete stop but power still remains on the track. Slide the direction switch on the power supply to the opposite direction and increase the throttle setting again to allow the locomotive to begin running in the opposite direction.

Using DCS With DC Power

MTH's revolutionary Digital Command System, or DCS, allows users to control their RailKing One-Gauge locomotives in a command control environment. User's can remotely access hundreds of features inside each RailKing One-Gauge locomotive with the wireless remote control. Digital signalling and an easy-to-use interface make using DCS a snap. More information on DCS can be found on page 26 or by visiting www.protosound2.com.



Activating Features Using AC Power

Using an AC output transformer equipped with a whistle and bell button will unlock dozens of features inside your RailKing One-Gauge locomotive. Operation is simple by following the simple steps below and on the following pages.

Start Up - Turn the throttle knob up ½-way, until the engine headlight shines bright.

Put the engine into motion by pressing the Direction button on your transformer once. (hold it for approximately 1 second)

If the engine does not begin to move as soon as you firmly press the Direction button, you may not have sent enough voltage to the track to make the train move. Turn the throttle up a bit higher until the train begins to move.

Throttle - To increase or decrease track voltage, and therefore train speed, turn the throttle control knob. Turning clockwise will increase voltage and speed, while turning counterclockwise will decrease voltage and speed. The engine will maintain the speed you set after you release the throttle until you turn it again to change the voltage and speed.

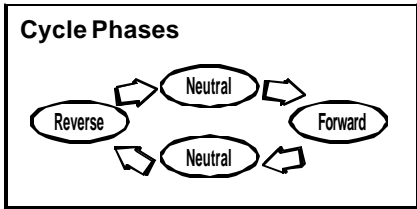

Bell - To sound the bell, in an engine equipped with a bell firmly press and release the Bell button. To turn the bell off, press and release the Bell button again. The bell will continue to ring from the time you turn it on until you press and release the button again to turn it off.

Horn/Whistle - To sound the whistle, firmly press the Horn/Whistle button. The whistle will sound for as long as you continue to depress the button. It will stop when you release the button.

Direction Your train is programmed to start in neutral. The train will always cycle neutral-forward-neutral-reverse with each press and release of the direction button. The engine is programmed to restart in neutral each time the track voltage is turned off for 25 seconds or more.

Manual Volume Adjustment - To adjust the volume of all sounds made by this engine, turn the master volume control knob located inside the boiler front clockwise to increase the volume and counter-clockwise to decrease the volume.



Figure 4: Manual Volume Adjustment (lower knob)

Proto-Sound 2.0

Operating Instructions

The following pages contain the operating instructions for Proto-Sound 2.0 RailKing One-Gauge locomotives when operated with AC output transformers in conventional mode only. Instructions for accessing DCS command mode features accompany the DCS Remote Control System equipment.

Activating Proto-Sound 2.0 Conventional Mode Features

Proto-Sound 2.0 features are activated by sequences of Bell and Horn button pushes described below. Please read the full descriptions of each feature before using it. To use these buttons to activate features rather than to blow the horn or ring the bell, you should

Timing Chart				
Press Horn Short & Firm	½ Sec. Pause	Press Bell Short & Firm	½ Sec. Pause	Press Bell Short & Firm
Total Time Lapse: 1 ½ Seconds				

Feature to Be Activated	Button Code:
Freight Yard Announcements	1 Bell, 2 Horns
Speed Control On/Off	1 Horn, 2 Bells (from Neutral only)
Lock into a Direction	1 Horn, 3 Bells
Reset to Factory Defaults	1 Horn, 5 Bells (from Neutral only)

Freight Yard Sounds (FYS)

Your engine is equipped with a sound package of freight yard sounds that you can play when you pull into a yard. Each sequence described below will play as long as it is left on, randomly generating sounds, but be sure to allow approximately 30 seconds between the button pushes described below to allow the FYS sufficient time to run through each sequence.

- To cue the sound system to play the FYS, quickly but firmly tap the Bell button once followed by 2 quick taps of the Horn button while the engine is moving. Tap the buttons quickly but allow approximately ½ second between each press.
- Press the Direction button once to stop the engine. This will trigger the first sequence of FYS. The reverse unit is temporarily disabled so that the train will not move as you use the Direction button to trigger the sounds, and Proto-Sound 2.0 has disabled operator control over the Horn and Bell buttons until the full FYS sequence is complete.
- After waiting about 30 seconds for that sequence to run, press the Direction button again to trigger the second sequence of FYS.
- After about 30 seconds, press the Direction button again to trigger the third FYS sequence.
- Again, after allowing about 30 seconds for that sequence to run, press the Direction button one more time to trigger the fourth and final FYS sequence. The FYS will continue, and within a few seconds, the engine and bell will start and move out on its own at the current throttle setting, in the same direction it was traveling when you began the sequence. Once the bell turns off, the operator regains control of the transformer's bell and Horn buttons and can ring the bell or blow the Horn as usual.

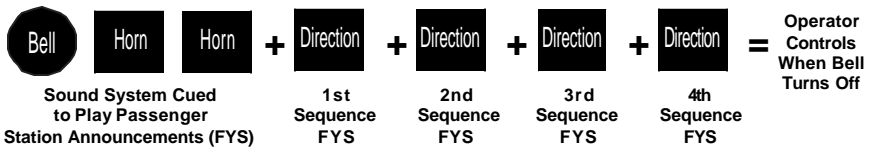

Tips on Using FYS

- You can terminate FYS at any time by turning off power to the track for 15 seconds.
- You do not have to be in Forward to use FYS. At the conclusion of the full sequence, the train will pull away from the station in whatever direction you were going when you activated the feature.
- You can use FYS even if you are double-heading with another engine. If the second engine is not equipped with Proto-Sound 2.0, you must remember not to leave the throttle at a high voltage level once you have stopped the engine to run the FYS. Otherwise, the engine without FYS will begin vibrating on the track as its motors strain to move the train, since they cannot be automatically disabled during the FYS cycle (or if an original Proto-Sound engine, FYS are triggered differently and that engine's motor-disable feature will not be active when you run FYS in Proto-Sound 2.0).
- FYS can be triggered from Neutral. It will operate the same as if triggered while in motion except that, at the conclusion of the FYS, the engine will depart in the next direction of travel, as opposed to the direction it was traveling before entering Neutral.

Speed Control

M.T.H. engines equipped with Proto-Sound 2.0 have speed control capabilities that allow the engine to maintain a constant speed up and down grades and around curves, much like an automobile cruise control. You can add or drop cars on the run, and the engine will maintain the speed you set.

While the engine is programmed to start with the speed control feature activated, you can opt to turn it off. This means the engine's speed will fall as it labors up a hill and increase as it travels downward. It is also affected by the addition or releasing of cars while on the run. Because the engine will run more slowly at a given throttle voltage when speed control is on than when it is off, you should adjust the throttle to a lower power level for operation with speed control off to avoid high-speed derailments. When speed control is off, the volume will drop to allow for better low voltage operation.

To turn speed control on and off, put the engine in neutral, then quickly tap the transformer's Horn button one time then quickly tap the Bell button two times, allowing approximately 1/2 second to lapse between each quick button press. Two horn blasts will indicate that the engine has made the change. Repeat the 1 horn, 2 bells code to return it to the other condition. You will want to do this during the initial neutral upon start-up if you ever couple this engine to another engine that is not equipped with speed control to avoid damaging the motors in either engine. Each time you shut down the engine completely, it will automatically turn speed control on.



Place
Engine into
Neutral



=

Speed Control
Two Horn Blasts
(indicates change is made)
Repeat to Return
to Normal Condition

Locking Locomotive Into A Direction

You can lock your engine into a direction (forward, neutral, or reverse) so that it will not change directions. To do this, put the engine into the direction you want (or into neutral to lock it into neutral), run it at a very slow crawl (as slowly as it will move without halting), and quickly but firmly tap the Horn button once followed by three quick taps of the Bell button, allowing approximately ½ second to lapse between each quick button press. Two horn blasts will indicate that the engine has made the change. The engine will not change direction (including going into neutral) until you repeat the 1 horn, 3 bells code to return the engine to its normal condition, even if the engine is kept without power for extended periods of time.

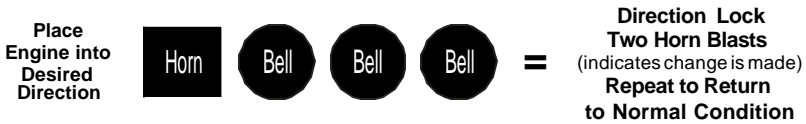

Reset To Factory Default

To override the settings you currently have assigned to the engine and reset it to its factory defaults, while in Neutral tap the Horn button quickly once, followed by five quick taps of the Bell button, allowing approximately ½ second to lapse between each quick button press. Two horn blasts will indicate that the engine has made the change.

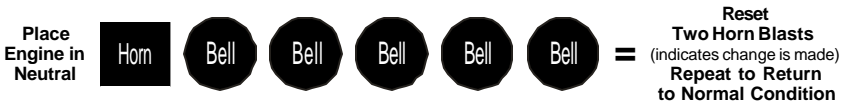

Automatic Sound Effects

Certain Proto-Sound 2.0 sound effects automatically play in programmed conventional mode conditions:

- Squealing Brakes play any time the engine's speed decreases rapidly.
- Cab Chatter plays at random intervals when the engine idles in neutral.
- Engine Start-up and Shut-down sounds play when the engine is initially powered on or is powered off for five seconds or more.

Maintenance

Lubricating and Greasing Instructions

The engine should be well oiled and greased in order to run properly.

You should regularly lubricate all side rods and linkage components to prevent them from squeaking. Use light household oil and follow the lubrication points marked “L” in Fig. 9. Do not over-oil. Use only a drop or two on each pivot point.

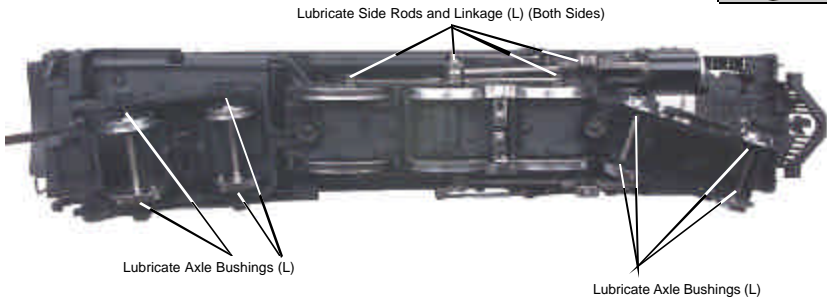

Figure 9: Lubricating The Chassis

You should also grease the leading and trailing locomotive truck tongues to enhance their ability to slide on the chassis. Follow the grease points shown on Fig. 10.

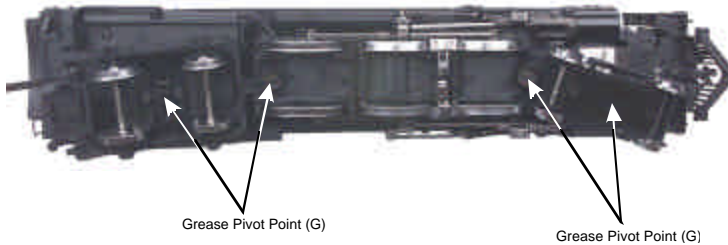

Figure 10: Greasing the leading and trailing truck pivot points.

The locomotive’s internal gearing was greased at the factory and should not need additional grease until after 50 hours of operation or one year, whichever comes first. To access the gear box and axles, do the following:

1. Turn the engine upside down and remove the leading truck mounting screws (you will have to remove the leading truck plate as well) to gain access to the front boiler mounting screw. Remove that screw and the two rear boiler mounting screws as seen in Figure 11.



Figure 11: Removing The Body

2. After removing the boiler mounting screws, separate the boiler from the chassis and turn the chassis upside down.
3. Next, locate the pickup assembly behind the middle set of drive wheels and remove its mounting screw as seen in Figure 13.

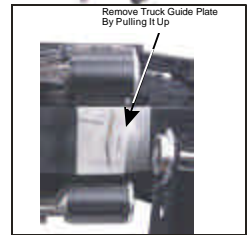

Figure 12

3. Locate and remove the four gearbox bottom access cover screws as seen in Figure 14.
4. Turn the chassis right side up and remove the two chassis weight mounting screws as seen in Figure 15.
5. After removing the chassis weight mounting screws, lift the weight out of the chassis and remove the gearbox top access cover mounting screws as seen in Figure 16.

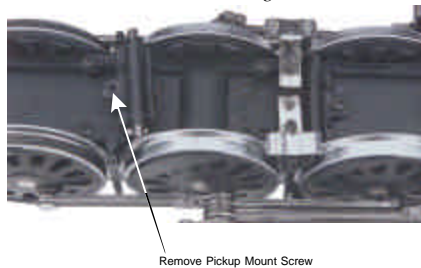

Figure 13: Locate and remove the pickup mounting screw

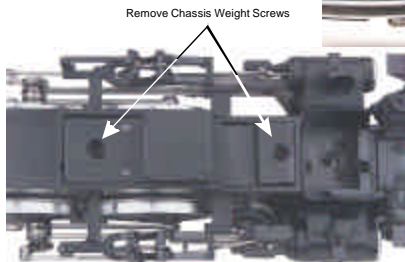

Figure 15: Chassis Weight Mounting Screws

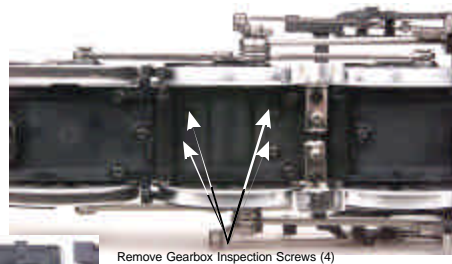

Figure 14: Removing The Gear Box Bottom Access Cover

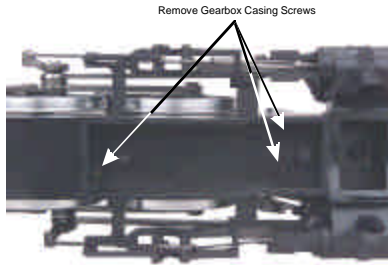

Figure 16: Gear Box Top Access Cover

6. Lift the gearbox up and out of the chassis, rotate 190 degrees to reveal the now exposed gears and lubricate with a light grease.

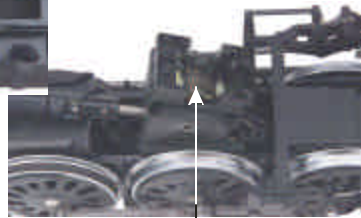

Figure 17: Insert Grease Into Gear Box

Traction Tire Replacement Instructions

Your locomotive is equipped with two neoprene rubber traction tires on the rear set of flanged drivers. While these tires are extremely durable, you may need to replace them at some point.

1. Remove the side rods from the wheels in order to slip the new tire over the grooved drive wheel. Make sure to note the position of all rods before removing.
2. Make sure the old tire has been completely removed from the groove in the drive wheel, using a razor blade or small flathead screwdriver to pry away any remains.
3. Slip the new tire onto the wheel. You may find it useful to use two small flathead screwdrivers to stretch the tire over the wheel.
4. If you twist the tire while stretching it over the wheel, you will need to remove and reinstall the tire. Otherwise your engine will wobble while operating.
5. Make sure the tire is fully seated inside the groove. Use a razor blade to trim away any excess tire that doesn't seat itself inside the groove properly.
6. Reinstall the side rods in the same positions as noted. Failure to align rods may cause binding or damage to the drive system.

One set of replacement tires is packaged with your model. Additional sets are available directly from the M.T.H. Parts Department (order online: www.mth-railking.com, e-mail: parts@mth-railking.com; mail: 7020 Columbia Gateway Drive, Columbia MD 21046-1532, FAX: 410-381-6122).

Light Bulb Replacement Instructions

The locomotive and tender lights are controlled by a constant voltage circuit in the engine. They can be removed and replaced when they burn out by separating the boiler from the chassis as seen on page 16. Once the boiler has been separated, see the illustrations below to remove the headlight and firebox glow light. The tender body can be removed by unscrewing the six (6) mounting screws located on the tender chassis.

You can obtain replacement bulbs directly from the M.T.H. Parts Department (order online: www.mth-railking.com, e-mail: parts@mth-railking.com; mail: 7020 Columbia Gateway Drive, Columbia MD 21046-1532, FAX: 410-381-6122).

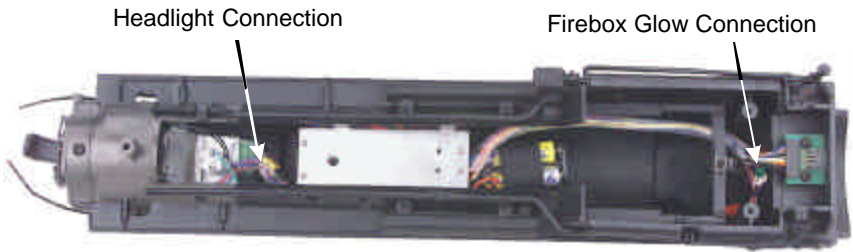

Figure 18: Boiler Wire Harness

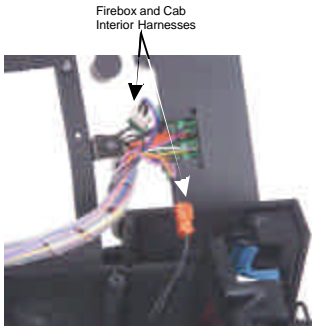

Figure 19

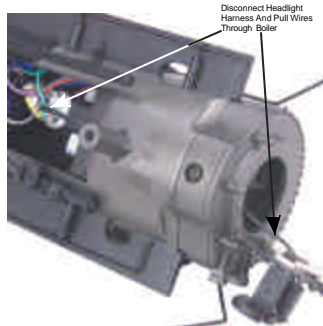

Figure 20

To Replace:

Gently pull the wires until the bulb comes free of the housing. Push the new bulb into place and reconnect the wires.

Self Charging Battery Back-Up

The special NiCad AA self-charging batteries recharge continuously during train operation and should last between one and five years. The batteries should not leak or cause any damage to your engine. Depending upon when your engine was built, it may need to be charged right out of the box. If engine sounds seem distorted or garbled at low voltages or become silent when power from the transformer is turned off, test the battery to determine whether it should be recharged or replaced.

Test: Put the engine in neutral and leave the track voltage at 10-12 volts (high enough for the lights to shine brightly and the engine to move steadily) for 15 minutes.

Recharge: If the sounds are improved at the end of the 15-minute test charge, the battery charge has run down and can be recharged. There are a number of ways you can do this:

- Leave the engine in neutral with track voltage at 10-12 volts for 6-7 hours so the battery can fully recharge (if your engine has a smoke unit, be sure it is turned off).
- Remove the batteries and recharge them in a NiCad battery charger.

Replace: If the sounds are not improved at the end of the 15-minute test charge, it is time to replace the batteries. Replacement batteries can be ordered through MTH. The batteries are located inside the locomotive boiler. See page 16 for instructions on removing the boiler from the chassis.

ProtoSmoke® Unit Operation

This RailKing One-Gauge steam locomotive contains a self-powered smoke unit that outputs smoke through the smokestack on the roof of the engine. The smoke unit is essentially a small heating element and wick that soaks up and then heats a mineral oil-based fluid that emits a harmless smoke. The smoke is then forced out of the stack by a small electric fan. Smoke volume is controlled by the Proto-Sound 2.0 system.

With a few easy maintenance steps, you should enjoy trouble-free smoke unit operation for years.

When preparing to run this engine, add 30-40 drops of smoke fluid through the smokestack (see Fig. 21). We recommend M.T.H. ProtoSmoke, Seuthe, LGB, or LVTS fluids. Do not overfill the unit or the fluid may leak out and coat the interior engine components.



Figure 21

If you choose not to add the fluid (or have already added the fluid but choose to run smoke-free), turn off the smoke unit switch located inside the boiler front door (see Fig. 22).

Failure either to add fluid to the unit or to turn it off may damage the smoke unit heating element and/or wick material.

When the smoke output while running the engine begins to diminish, add another 10-15 drops of smoke fluid or turn the smoke unit off.



Figure 22

When storing the unit for long periods of time, you may want to add about 15 drops of fluid to prevent the wick from drying out.

After removing the engine from storage, add another 25 drops of fluid, letting the wick soak up the fluid for 15 minutes prior to operation.

If you experience poor or no smoke output when the smoke unit is on and has fluid, check the wick to see if it has become hard, blackened, and unabsorbent around the heating element. To remove the smoke unit you will remove the smoke unit by unscrewing it from the bottom of the boiler as seen in Figure 23.

Once the unit is freed, remove the inspection cover (Fig. 24). Inspect the wick; if it is darkly discolored and hard, it should be replaced.

Replacement parts and wick replacement instructions are available directly from the M.T.H. Parts Department (order online: www.mth-railking.com, e-mail: parts@mth-railking.com; mail: 7020 Columbia Gateway Drive, Columbia MD 21046-1532, FAX: 410-381-6122).



Figure 23

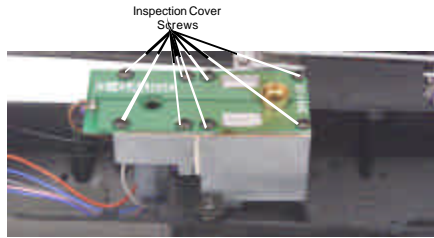

Figure 24

Troubleshooting Proto-Sound® 2.0 Problems

Although Proto-Sound 2.0 has been designed and engineered for ease of use, you may have some questions during initial operation. The following table should answer most questions. If your problem cannot be resolved with this table, contact M.T.H. for assistance (telephone: 410-381-2580; fax: 410-423-0009; service@mth-railking.com, 7020 Columbia Gateway Drive, Columbia MD 21046-1532).

Starting Up	Remedy
When I first turn the power on, the engine will not begin to run. I have to turn the throttle off and then on again to get the engine to operate.	This is normal behavior. To prevent accidental high-speed start-ups, Proto-Sound 2.0 is programmed to start up in neutral anytime track power has been turned off for several seconds. See the "Basic Operation" section for more details.
Horn	Remedy
When I press the whistle button, the bell comes on instead.	Reverse the transformer leads.
I can't get the horn to blow when I press the whistle button.	You may be pressing the button too quickly. Try pressing the whistle button more slowly, taking approximately one full second to fully depress the button.
Bell	Remedy
When I press the whistle button, the bell sounds.	Reverse the transformer leads.
I can't get the bell to ring when I press the bell button.	You may be pressing the button too quickly. Try pressing the bell button more slowly, taking approximately one full second to fully depress the button.
The bell won't work on a separate bell button.	Check the wiring of the separate button.

C ab Chatter	Remedy
Sometimes the Cab Chatter sounds don't play.	Cab Chatter plays only in neutral at random intervals.
Lock-out	Remedy
I can't get the engine to run after I power up the transformer. It sits still with the engine sounds running.	The engine is locked into the neutral position. Follow the procedure in the "Lock into a Direction" section.
The engine won't lock into forward, neutral, or reverse.	Engine speed must be below 10 scale mph (approx. 10 volts or less in conventional mode).
Volume	Remedy
The sounds seem distorted, especially when the whistle or bell is activated.	Proto-Sound 2.0 volume is set too high. Turn the volume control knob on the bottom of the chassis counter-clockwise to reduce the volume.
B attery	Remedy
The engine will not leave the initial neutral setting.	Check to be sure the battery is installed and fully charged. See the "Self-Charging Battery Back-Up" section.
I get no sounds when the engine shifts between directions.	The battery may be dead or need to be charged. See the "Self-Charging Battery Back-Up" section.
After I turn off my transformer, my engine continues to make sounds before quitting.	Proto-Sound 2.0 is designed to continue to sound for a few seconds after power to the track has been shut off.
FYS	Remedy
The FYS sounds occasionally repeat themselves.	Proto-Sound 2.0 has a built-in random number generator that randomly selects each sound clip to play. Because there are a limited number of sound clips available in each FYS sequence, it is probable that some of these sound clips will be repeated from time to time.

FYS	Remedy
Once in FYS, the engine doesn't go into reverse.	So that FYS effects can be as realistic as possible, Proto-Sound 2.0 disables the reversing unit whenever FYS is enabled. This way the engine remains still at its stop as the operator cycles through the FYS sequences.
When the FYS enters its last sequence the bell automatically comes on.	FYS is programmed to start ringing the bell at that point. After approximately 12 rings of the bell, it will automatically turn off.
When FYS is enabled, pressing the whistle and bell buttons has no effect.	Because FYS must control various effects in each sequence, Proto-Sound 2.0 takes control of these sound effects until you exit FYS.
I push the direction button but the next sound clip in the sequence does not play or the engine does not come out of FYS after fourth press of the direction button.	Each FYS clip must play for approx. 30 seconds before FYS will advance to the next step in the FYS cycle. Wait at least 30 seconds in each FYS sound clip before pressing the direction button.

Transformer Compatibility and Wiring Chart

Proto-Sound 2.0 is designed to work with most standard AC transformers and all DC power supplies. The chart below lists the many compatible AC transformers. Note that many of the operational commands described in these instructions require a bell button, so if your transformer does not have its own bell button, you should consider adding one to get the full benefit of the system. In addition, the chart details how the terminals on these transformers should be attached to your layout. DC transformers employing PWM (pulse width modulation) should not be used with the separately sold DCS system.

Transformer Model	Center Rail	Outside Rail	Min/Max. Voltage	Power Rating	Transformer Type
MTH Z-500	Red Terminal	Black Terminal	0-18v	50-Watt	Electronic
MTH Z-750	Red Terminal	Black Terminal	0-21v	75-Watt	Electronic
MTH Z-4000	Red Terminal	Black Terminal	0-22v	390-Watt	Electronic
Lionel 1032	U	A	5-16v	90-Watt	Standard
Lionel 1032M	U	A	5-16v	90-Watt	Standard
Lionel 1033	U	A	5-16v	90-Watt	Standard
Lionel 1043	U	A	5-16v	90-Watt	Standard
Lionel 1043M	U	A	5-16v	90-Watt	Standard
Lionel 1044	U	A	5-16v	90-Watt	Standard
Lionel 1053	U	A	8-17v	60-Watt	Standard
Lionel 1063	U	A	8-17v	60-Watt	Standard
All-Trol	Left Terminal	Right Terminal	0-24v	300-Watt	Electronic
Dallee Hostler	Left Terminal	Right Terminal			Electronic
Lionel LW	A	U	8-18v	75-Watt	Standard
Lionel KW	A or B	U	6-20v	190-Watt	Standard
Lionel MW	Outside Track Terminal	Inside Track Terminal	5-16v	50V.A.	Electronic
Lionel RS-1	Red Terminal	Black Terminal	0-18v	50V.A.	Electronic
Lionel RW	U	A	9-19v	110-Watt	Standard
Lionel SW	U	A	Unknown	130-Watt	Standard
Lionel TW	U	A	8-18v	175-Watt	Standard
Lionel ZW	A,B,C or D	U	8-20v	275-Watt	Standard
Lionel Post-War Celebration Series ZW	A,B,C or D	Common	0-20v	135/190 Watt	Electronic

* Conventional Mode Only

Additional Features Accessible With The DCS Remote Control System

(Additional equipment required)

While conventional mode operation of a Proto-Sound 2.0 engine yields wonderfully realistic sound and several train control features, command mode operation allows the user to access a world of command functions never before available to G Gauge railroaders. With the addition of the DCS Remote Control System (including a DCS remote handheld and Track Interface Unit) users gain many advanced features, including:

- DCS Proto-Speed Control - Establishes desired locomotive speed in scale miles per hour increments via a thumbwheel control and allows operator to set maximum speed and acceleration/deceleration rates
- ProtoSmoke® Variable Output Control - Controls how much smoke each engine outputs and matches smoke to locomotive speed
- Locomotive Lighting Control - Controls locomotive headlights, marker and interior lights, beacon lights, ditch lights, and MARS lights
- Emergency Stop-Single button push stops all Proto-Sound 2.0 trains but does not turn off the power
- One Touch Global Mute/UnMute-Single button mutes or unmutes all DCS-controlled locomotives' user-defined actions, including sound, lights, and smoke
- Proto-Dispatch Operation-Public Address-like feature allows users to speak through locomotive speaker during operation
- Proto-Cast-Allows users to play audio recordings through locomotive speaker during operation
- Proto-Doppler Sound Effects Set Up-Users can configure locomotive for Doppler Operation, including setting distance points for Doppler start, repeat, and stop modes
- Independent Volume Control of Engine Sounds, Bell, Horn & Whistle for each Locomotive
- Control up to 50 different DCS-Equipped Locomotives at one time with multiple TIUs
- Proto-Effects™ Set Up-User can select individual Proto-Effects™ operations to be active or inactive, including cab chatter, train wreck sounds, coupler sounds, and wheel clickety-clack sounds
- Direction Control Set Up-User can set initial individual start-up direction (start in forward or reverse) for double-heading operations
- Locomotive Consist Set-up-User can determine locomotive values for consist make-ups, allowing multiple locomotives belonging to a consist to operate together

Service & Warranty Information

How to Get Service Under the Terms of the Limited One-Year Warranty

For warranty repair, follow the instructions below to obtain warranty service.

First, e-mail, write, call or fax an Authorized M.T.H. Service Center in your area or M.T.H. Electric Trains to obtain Repair Authorization. You can find the list of Authorized Service Centers on the M.T.H. website, www.mth-railking.com. Authorized Service Centers are required only to make warranty repairs on items sold from that store; all other repairs may or may not be done at the store's own discretion. Otherwise, contact M.T.H. (fill out the Service Contact form in the Service Section of www.mth-railking.com; send US mail to the address listed below; tel: 410-381-2580; fax: 410-423-0009), stating when the item was purchased and describing the problem. If you contact M.T.H., you will be given a return authorization number to assure that your merchandise will be properly handled upon its receipt.

CAUTION: Make sure the product is packed in its original factory packaging including its foam and plastic wrapping material so as to prevent damage to the merchandise. The shipment must be prepaid and we recommend that it be insured. *A cover letter including your name, address, daytime phone number, e-mail address (if available), Return Authorization number, a copy of your sales receipt and a full description of the problem must be included to facilitate the repairs. Please include the description regardless of whether you discussed the problem with a service technician when contacting the Service Center or M.T.H. for your Return Authorization.*

Limited One-Year Warranty

All M.T.H. products purchased from an Authorized M.T.H. Train Merchant are covered by this warranty. See our website at www.mth-railking.com or call 1-888-640-3700 to identify an Authorized M.T.H. Train Merchant near you.

M.T.H. products are warranted for one year from the date of purchase against defects in material or workmanship, excluding wear items such as light bulbs, pick-up rollers, batteries, smoke unit wicks, and traction tires. We will repair or replace (at our option) the defective part without charge for the parts or labor, if the item is returned to an Authorized M.T.H. Service Center or M.T.H. Electric Trains within one year of the original date of purchase. This warranty does not cover damages caused by improper care, handling, or use. Transportation costs incurred by the customer are not covered under this warranty.

Items sent for repair must be accompanied by a return authorization number, a description of the problem, and a copy of the original sales receipt from an Authorized M.T.H. Train Merchant, which gives the date of purchase. If you are sending the item to M.T.H., call 410-381-2580, fax 410-423-0009, or e-mail the Service Department at service@mth-railking.com to obtain a return authorization number. If you are sending this product to an Authorized Service Center, contact that Center for their return authorization.

This warranty gives you specific legal rights, and you may have other rights that vary from state to state.

Service Department, M.T.H. Electric Trains, 7020 Columbia Gateway Drive, Columbia, Maryland, 21046-1532



7020 Columbia Gateway Dr. - Columbia, MD 21046
Information: 410-381-2580 Fax: 410-381-6122
www.mth-railking.com

PARTICIPATING RETAILER LIST

ALABAMA

SOUTHERLAND STATION
 HUNTSVILLE
 256-533-4720
railway@bellsouth.net

ARIZONA

ARIZONA TRAIN DEPOT
 MESA
 480-833-9486
sales@arizonatraindepot.com
www.arizonatraindepot.com/

CALIFORNIA

DOLLHOUSES, TRAINS & MORE
 NOVATO
 415-883-0388
kbecker@cmc.net

TIN PLATE JUNCTION

OAKLAND
 510-444-4780
TOYTRAINS@email.msn.com

COLORADO

MIZELL TRAINS Inc
 WESTMINSTER
 303-429-4811
mizelltrains@cs.com
www.mizelltrains.com

CONNECTICUT

SHELTON RAILROAD SYSTEMS
 SHELTON
 203-924-8761
adriani@clearlight.com
 NEW ENGLAND HOBBY SUPPLY
 MANCHESTER
 860-646-0610
bobbell@nehobby.com

DELAWARE

K R R B MODEL TRAINS INC.
 NEWARK
 302-292-2779
info@krbb.com
www.krbb.com

FLORIDA

DEPOT HOBBY SHOP
 LAKE WORTH
 561-585-1982
jimmy11982@aol.com
www.depotohobbies.com

COLONIAL PHOTO & HOBBY

ORLANDO
 407-841-1485
trains@colonialphotoandhobby.com

WARRICK CUSTOM HOBBIES

PLANTATION
 954-370-0708
info@warrickcustomhobbies.com
www.warrickcustomhobbies.com

FRANK'S TRAINS & HOBBIES INC.

OLDSMAR
 813-855-1041
FTH@allhobbies.com
www.allhobbies.com

READY TO ROLL

MIAMI
 305-688-8868
rtrtrains@aol.com
www.readytorolltrains.com

ILLINOIS

BIKE & CHOO CHOO CONNECTION
 SCHAUMBURG
 847-882-7728
trainconnection@aol.com

INDIANA

Y. O. R. K. TRAINS
 MUNSTER
 219-838-9999
yorktrains@aol.com

SAMUELSON'S TRAIN SHOP

VALPARAISO
 219-462-2708

LOUISIANA

AMERICA'S TRAIN YARD
 BATON ROUGE
 225-926-5592

MAINE

WHEELS, WINGS & THINGS
 LUDLOW
 207-532-6277
irc44@javanet.com

MARYLAND

ENGINE HOUSE HOBBIES
 GAITHERSBURG
 301-590-0816
lucciecerise@aol.com

J & B TRAINS

HAGERSTOWN
 240-420-4930

HOBBYTOWN U S A

FREDERICK
 301-694-7395

PURKEY'S TOY TRAINS

SYKESVILLE
 410-549-6061
wiley@oldmainline.com

THE TRAIN ROOM

HAGERSTOWN
 301-745-6681

MASSACHUSETTS

NORTHEAST TRAINS
 PEABODY
 978-532-1615
www.netrains.com

MICHIGAN

BRASSEUR ELECTRIC TRAINS INC.
 SAGINAW
 517-793-4753
bob@traindoctor.com
www.traindoctor.com

MISSOURI

SWITCH STAND
SAINT LOUIS
314-781-4458
r41877@earthlink.com

MARK TWAIN HOBBY CENTER

ST. CHARLES
636-946-2816
webmaster@hobby1.com
www.hobby1.com

NEW HAMPSHIRE

TREASUREDTOYS
SALEM
603-898-7224
ttoys@treasured-toys.com
www.treasured-toys.com

RAILROAD SPECIALTIES

HUDSON
603-882-5566
crew@electric-trains.com
www.electric-trains.com

NEW JERSEY

TRAINS & THINGS
TRENTON
609-883-8790
trainsanthings@aol.com

GRAND CENTRAL STATION

KEARNY
201-955-6200
228gene@gateway.com

HOBBYMASTERS, INC

RED BANK
732-842-6020
hobbymasters@hobbymasters.com

HOLLY BEACH TRAIN DEPOT

WILDWOOD
609-522-2379
larry@pro-usa.net

COAST TRAINS AND COLLECTIBLES

WALL
732-556-9005
coasttrain@aol.com
www.coasttrains.com

J & B TRAINS, INC.

MAPLE SHADE
856-414-0092
BASE1130@aol.com

HOBBY SHOP

MATAWAN
732-583-0505
hobbyshopnj.com

ATLANTIC RAILS

HAMMONTON
609-567-8490
bobcap@pics.com
www.atlanticrails.com

COUNTRY AND STUFF

ANDOVER
973-786-7086
stuff@crystal.palace.net

RIDGEFIELD HOBBY

RIDGEFIELD
201-943-2636

COLUMBUS TRAIN STATION

COLUMBUS
609-518-1800

NEW YORK

AURORA RAILS & HOBBIES
EAST AURORA
716-652-5718
rk82141@aol.com

AMERICANA STORE

TIVOLI
845-757-4246
mthdepot@valstar.net

NASSAU HOBBY CENTER, INC.

FREEPORT
516-378-9594
Charlienassau@aol.com

KROSS HARDWARE

WEST BABYLON
631-669-3069
1989@aol.com

CITY DEPOT, INC.

NEW HAMPTON
845-374-3010
citydepot@frontiernet.net
www.citydepot.com

NORTH CAROLINA

DRY BRIDGE STATION
MOUNT AIRY
336-686-9811
mikek@drybridgestation.com
www.drybridgestation.com

THE FREIGHT YARD

SMITHFIELD
919-934-6229
disbissette@aol.com

TRAINS LTD.

CHARLOTTE
704-566-9070
modelrns@bellsouth.net
www.trainstld.com

THE ROUNDHOUSE & BACKSHOP

CARY
919-465-0810

OHIO

DIXIE UNION STATION
MASON
513-459-0460
rockylane@core.net
www.dixieunionstation.com

RICK'S TOY TRAINS

TOLEDO
419-478-0171

T & K HOBBY SHOP

BRIDGEPORT
740-633-6607
salea@tkhobbies.com
www.tkhobbies.com

TRAINS-N- THINGS

CANTON
330-499-1666
trains@sssnnet.com

PARMA HOBBY

CLEVELAND
216-741-6440
info@parmahobby.com

GLEN'S TRAIN SHOP

AKRON
330-253-6527

E & S TRAINS

AKRON
330-745-0785

GRAND PACIFIC JUNCTION

OLMSTEAD FALLS
440-235-4777
gpjmrr@juno.com
HUDSON TOY, TRAIN & HOBBY
HUDSON
330-653-2997
epickers@aol.com

DAVIS ELECTRONICS

MILFORD
513-831-6425
davis trains@fuse.net
www.davis trains.com

SANDY'S HOBBY'S & COLLECTIBLES

ELYRIA
440-365-9999
sandyshobb@aol.com

ERIE RAILWAY DEPOT

TROY
937-440-9972
orville@gte.net

CLEARVIEW TRAIN & HOBBY

LORAIN
440-277-4488
klogar@erinet.net
www.clearviewtrainandhobby.com

PENNSYLVANIA

FAIRCHANCE PHARMACY
FAIRCHANCE
724-564-7817
mhdealer@aol.com
www.hhs.net/fairchance

THE STATION
NEW CUMBERLAND
717-774-7096
station@paonline.com
BUSSINGER TRAINS
AMBLER
215-628-2366
choochoos@icdc.com
www.icdc.com/~btrains

CHARLEROI SWEEPER CENTER
CHARLEROI
724-483-3397

AMERICAN HOBBY CENTER
ALIQUIPPA
724-378-3930
american@icubed.com

CRANBERRY HOBBY DEPOT
CRANBERRY TWP
724-776-3640
JAdams6113@aol.com

ALLENTOWN TOY TRAIN SERVICE
ALLENTOWN
610-821-0740

ON THE RIGHT TRACK
ALTOONA
814-942-4345

JIM'S TRAIN SHOP
HOMER CITY
724-479-2026
sudsy@stargate.net

YE OLDE TRAIN & CHRISTMAS
SHOPPE
BOYERTOWN
610-369-0755
www.yoldetrain.com

TOBY TYLER'S HOBBY CENTER
PITTSBURGH
412-653-5030
tobytyler111@cs.com

BUSTLETON TRAIN SHOP
PHILADELPHIA
215-698-7266

CHESTNUT TOYBOX
PHILADELPHIA
215-545-0455
chestnuttoy@earthlink.net

THE CABOOSE
LEIGHTON
570-386-5352
www.thecaboosehobbies.com
victen@ptd.net

SOUTH CAROLINA
EMERALD TRAIN & HOBBY
GREENWOOD
864-223-2247

TENNESSEE
MODEL RAILROAD & HOBBY SHOP
MEMPHIS
901-384-6500
mrhs99@earthlink.net
www.modelrailroadandhobby.com

TEXAS
HOBBY TIME
AMARILLO
806.352.9660
don.l.harris.@hobby-time.com

VIRGINIA
TRAIN DEPOT
MANASSAS
703-335-2216

NORGE STATION
WILLIAMSBURG
757-564-7623
norgetrains@cs.com

NUTBUSH EXPRESS
VICTORIA
804-696-1902
thenutbushexp@meckcom.net

TOY TRAIN CENTER
RICHMOND
804-288-4475

T S G HOBBIES
WARRENTON
540-347-9212
tripl@mnsinc.com
www.mnsinc.com/tripi/tsg.htm

CHESTERFIELD HOBBIES
MIDLOTHIAN
804-379-9091
chsthobb@erols.com
www.chesterfieldhobbies.com

DAVIS HOBBY SUPPLIES
PORTSMOUTH
757-397-1983
ralph@davishobby.com
www.davishobby.com

LOCUST GROVE TRAINS
LOCUST GROVE
540-854-8955
lgtrains@aol.com
www.locustgrovetrains.com

WEST VIRGINIA
PATRICK'S TRAINS
WHEELING
304-232-0714
trains@palstrains.com
www.palstrains.com

WISCONSIN
SOMMERFELD'S TRAINS
BUTLER
262-783-7797
questions@sommerfelds.com
www.sommerfelds.com

G B T V & TRAINS
GREEN BAY
920-496-9697
rtycoon@netnet.net

GRAMPA'S TRAIN SHOP
RICE LAKE
715-234-2996
grampastrainsshop@yahoo.com

THE TRAIN STORE
WAUKESHA
262-650-6675

HOBBY OUTLET
FOND DU LAC
920-924-3770
hobby_outlet@hotmail.com

CANADA
ONTARIO
CREDIT VALLEY RAILWAY COMPANY
STREETSVILLE
905-826-1306
CVRCO@globalserve.net
www.cvrco.com

TOY TRAIN WORKSHOP
CUMBERLAND
613-833-3125
info@toytrainworkshop.com
www.toytrainworkshop.com

THE TRAIN ROOM
FERGUS
519-787-3280