



## RAILKING 4-6-0 STEAM ENGINE OPERATING INSTRUCTIONS



Thank you for purchasing the RailKing die-cast NYC 4-6-0 steam locomotive. The engine's die-cast body and tender are traditionally sized for operation on any O-27 or larger layout. The engine is compatible with most standard AC transformers, (see page 31 for a complete list of compatible transformers and wiring instructions) and is completely compatible with most other 3-rail locomotives, rolling stock and accessories.

The locomotive and tender are equipped with either a electronic whistle or the Proto-Sound® digital sound and train control system which contains several deluxe features that are simple and fun to operate. Each feature is described among the following pages which should be read before the engine is operated. For those of you who can't wait to get started, the ***Quick Start Basic Operating Instructions*** found on page 3 should be read so that you understand the basics of the operating system. Please note that some features are only found in the Proto-Sound® equipped engines and are marked as such. Features not marked as Proto-Sound® features are available in both versions.

RAILKING

# Table Of Contents

<b>QUICK START - BASIC OPERATION(All 3-Rail Models)</b>	3
<b>PROTOSMOKE™ UNIT OPERATION</b>	4
<b>PROTOSOUNDS® OPERATINGINSTRUCTIONS</b>	5
ProtoSound® DCRU® Reverse Unit Operation (All 3-Rail Models)	5
Whistle Operation	6
Bell Operation	6
ProtoCoupler™ Operation	7
Enhanced Neutral Steam Sounds	8
Squeaking Brake Sounds	8
Tips On Using The Squeaking Brake Sounds	9
Freight Yard Sounds (FYS)	10
Activating and Triggering Freight Yard Sounds	11
Tips On Using FYS Features	15
<b>MANUAL LOCK-OUT OPERATION</b>	16
Self-Charging Battery Backup System	17
Replacing The Proto-Sound® Battery	17
Manual Volume Adjustment of Proto-Sound®	18
<b>USING “RESET” TO PROGRAM PROTO-SOUND ®</b>	18
Entering RESET Options	19
Setting The Engine Volume	19
Programming For Squeaking Brake Operation	20
Programming For Whistle In Neutral Operation	20
Programming For ProtoCoupler™ Operation	21
Adjusting Chuff Rate	21
Programming For FYS Operation	22
Activating Remote Lockout Control	23
ResettingAll Proto-Sound® Options To Factory Default	23
<b>OIL &amp; LUBRICATION INSTRUCTIONS</b>	24
<b>TRACTION TIRE REPLACEMENT INSTRUCTIONS</b>	25
<b>LIGHT BULB REMOVAL &amp; REPLACEMENT</b>	26
<b>TROUBLE SHOOTING <i>PROTO-SOUND</i>® PROBLEMS</b>	27
Proto-Sound® RESET Feature Chart	30
Transformer Wiring Chart	31
<b>O-27 OPERATION</b>	32
<b>SERVICE AND WARRANTY INFORMATION</b>	36
<b>HOW TO GET SERVICE</b>	36
<b>LIMITED ONE YEAR WARRANTY</b>	36

# QUICK START - BASIC OPERATION

The RailKing NYC 4-6-0 contains state-of-the-art electronics with several built-in automatic features for incredibly realistic operation. Despite these advanced features, the NYC 4-6-0 is easy to operate with any compatible standard AC transformer (see the compatibility chart on page 34). All models are equipped with an operating smoke system that ***should be primed with smoke fluid before operating***. Adding 15 - 20 drops of fluid through the smoke stack should be sufficient. ***If you choose to not prime the units with fluid, turn the smoke unit switch located under the trailing truck to the OFF position.*** (See Figure 1) This will prevent any damage from occurring to the smoke unit when running the engine without a primed smoke unit. For more information see the section on page 4 on Smoke Unit operation.

The NYC 4-6-0 model is controlled by an electronic reverse unit (in mechanical whistle equipped engines) or by the Proto-Sound® Digital Sound and Train Control System (in Proto-Sound® equipped engines). In either model, the reverse unit operates in the same manner that all reverse units function by using forward, neutral and reverse states that are entered each time the throttle is turned on and off or by using the transformer direction switch (if so equipped).



Figure 1: Plugging in the tender harness

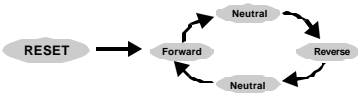

Figure 2: ProtoSound® DCRU® Cycle Phases

The Proto-Sound® reverse unit is designed to ignore dirty track, dead spots on switches or minor short circuits without disrupting the engine operation, even at slow,

prototypical speeds. Before the engine can be operated however, the reverse unit plug that extends out of the tender must be inserted into the receptacle at the back of the boiler cab as seen in Figure 1. Once the plug is inserted, the throttle on the transformer can be advanced. You will see that only the engine's lights come on and that on Proto-Sound® equipped engines, two dings from the sound system will chime followed by the steam compressor pump sounds. The engine does not run. This is known as the RESET state and is explained in more detail beginning on Page 6. The ProtoSound® electronics will not power the motor until the throttle is turned OFF and then ON again. At this point, the engine will now function just like any other electronic or mechanical E-unit.

# PROTOSMOKE™ UNIT OPERATION

The NYC 4-6-0 contains a self-powered smoke unit that outputs a steady stream of smoke through the smoke stack on the roof of the engine. The ON/OFF switch located next to the trailing truck must be in the ON position in order for the smoke unit to function. See Fig. 3 below.

The smoke unit is essentially a small heating element and wick which soaks up and then “cooks” a mineral oil-based fluid that emits a harmless smoke. The smoke is then forced out of the stack via a small electric fan which runs at a constant speed. However, the smoke intensity can be varied by increasing the transformer voltage setting. The higher the setting, the more intense the smoke output.

For best results, we recommend that you add 15 - 20 drops of ProtoSmoke™, Seuthe, LGB or LVTS fluid before you run the engine. If you don’t choose to add the fluid, then the smoke unit switch should be turned off. Failure to either add the fluid or turn the switch off could lead to damage to the smoke unit heating element and/or wicking. Add the fluid through the smoke stack hole. After adding the fluid, gently blow into the stack to eliminate any air bubbles. Do not overfill the unit as overfilling can cause the fluid to leak out and coat the interior engine components. When the smoke output begins to diminish while running the engine, an additional 10-15 drops of smoke fluid should be added or the smoke unit switch should be turned off. When storing the engine for long periods of time, you may want to add at least 15 drops of fluid to keep the wick soaked with fluid and prevent it from drying out. After removing the engine from storage, it is advisable to add another 25 drops of fluid, letting the wick soak up the fluid for 15 minutes prior to operation.

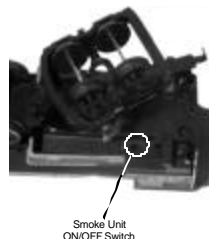

Figure 3: Smoke Unit Switch

## MAINTENANCE

**CAUTION:** *Operating the engine without smoke fluid and with the smoke unit switch in the ON position can damage your smoke unit wick, causing the wick to become hard, blackened and unabsorbant around the heating element. When this occurs, it may be difficult for the wick to soak up the smoke fluid resulting in poor or no smoke output. If that occurs, we recommend that you inspect and/or replace the wick taking care to not run the engine without fluid in the future. You can inspect the wick to see if it needs replacement by removing the smoke unit inspection cover from the body as seen in Fig. 4. After removing the chassis and inspection cover screws lift the inspection plate away and inspect the wick. If the wick is darkly discolored and hard, it should be replaced.*

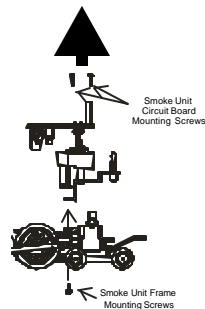

Figure 4: Inspecting The Smoke Unit

# PROTOSOUNDS® INSTRUCTIONS

The MTH ProtoSound® digital sound and train control system provides the operator with unprecedented realistic operation on your model railroad. In addition to actual NYC 4-6-0 engine, CD-equivalent 16-bit digital sounds, you get the following features:

**\* Built-In ProtoSound® DCRU® Reverse Unit \* Authentic Steam Whistle Sound\* Authentic Steam Bell Sound\* Squeaking Brake Sound\* Freight Yard Sounds\* Operating Remote Controlled ProtoCoupler™\* Self-Charging Battery Back-Up System With Automatic Battery Shut-Off\* Remotely Controlled Reverse Unit Lock-Out\* Remotely Adjustable Steam Engine Chuffing Volume\* Authentic Steam Engine Neutral Sounds\***

Each feature is described among the following pages. Though the system is easy to use, we encourage you to read the instructions thoroughly.

## PROTO-SOUND® REVERSE UNIT

As mentioned in the Basic Operating section, the engine is controlled by a ProtoSound® reverse unit that contains the standard forward-neutral-reverse states found on most reverse units. However, as described earlier, when power is first applied to the track, the reverse unit begins in RESET or what seems like a neutral state. Power must be interrupted again to get the locomotive to enter the forward state. It is this first RESET state that gives ProtoSound® its unique, remote controlled functions. The system will enter RESET whenever power to the track is off for three or more seconds. NEUTRAL will be referred to as the state between Forward and Reverse.

ProtoSounds® is equipped with a microprocessor, that, depending on the amount of memory it is allotted, allows the user to utilize several remotely activated functions. In the simplest terms, ProtoSounds® has its own "Computer" controlling these functions. In order to access many of these remotely controlled functions, the user must be in the RESET state to do so. RESET is entered anytime power to the locomotive has been off for more than 3 to 5 seconds. When the engine first enters RESET, the microprocessor initiates a system check to determine if the system, transformer and engine are operating correctly. This takes approximately 2.2 seconds during which you will hear the engine's compressor sounds begin. In order for ProtoSounds® to properly initiate the system check, do not advance the transformer throttle past 10 volts when you first enter RESET, wait for the compressor sounds to begin and then slowly turn the

transformer throttle to the off position and then back on again to enter the forward phase. Interrupting the power too quickly may cause the system to re-enter RESET (signaled by two dings of the bell). Should this happen, wait longer before interrupting the power to enter the Forward phase.

ProtoSounds® comes with several programmable functions, including remote Steam Chuffing Volume Adjustment, Separate Bell Button Operation (pre-programmed at the factory), Whistle In Neutral Operation, ProtoCoupler™ On/Off Control, Squeaking Brakes and Passenger Station or Freight Yard Proto-Effects. Each of these features are described in more detail later. You will notice that when in RESET, your engine will not respond to the whistle button with a horn blast or continuous bell ringing. In fact, when in RESET and the whistle button is depressed, only one single bell chime will be heard each time the whistle button is pressed. If you don't want to configure or change your locomotive using any of these programmable features, simply leave RESET and wait 2.2 seconds before interrupting the power to put the engine in forward. After you leave RESET, your engine will operate normally in all the direction states of forward, neutral and reverse. Remember though, once power is turned off for more than 3 seconds, the next time power is applied to the track, your engine will be back in RESET.

## WHISTLE OPERATION

Your NYC 4-6-0 ProtoSound® equipped engine is equipped with a digital recording of a steam whistle. The whistle sound can be activated anytime the engine is in forward or reverse by pressing the whistle button on your transformer. The whistle will continue to blow as long as the whistle button is depressed. The whistle will not function in RESET and must be configured through a RESET option to allow the whistle to work when the engine is in neutral. See page 20 for information on whistle programming in the *Using RESET To Program ProtoSounds®* section of this manual.

## BELL OPERATION

Your NYC 4-6-0 ProtoSound® equipped engine is equipped with a digital recording of an actual steam engine bell. The bell can be turned on or off with any separate bell button, like the Lionel® Railsounds® No. 5906 Bell Button, by simply pushing the button. If you don't have a separate bell button, the bell can be controlled through your transformer's whistle button whenever the engine is in NEUTRAL. The bell will never ring continuously in RESET (Remember NEUTRAL is the state between

Forward and Reverse). Once the bell is turned on, it will continue to ring when the engine is cycled into forward or reverse until you press the bell button or re-enter NEUTRAL and turn the bell off with the whistle button.

In fact, because of ProtoSounds® state-of-the-art design, the microprocessor remembers its last command. Therefore, unless you turn the bell off before you quit running your train, the next time you run the engine, the bell will come on. No matter whether you come back an hour later or a year later, the bell will begin chiming once the engine enters one of the three directional states.

To turn the bell on using the transformer's whistle button, turn on power to the track and cycle the engine into NEUTRAL. Turn the throttle to 8 volts or less (any higher voltage will arm the ProtoCoupler™) and press the whistle button. The bell should begin chiming. To turn the bell off, press the whistle button again. If you want to keep the bell on while running the engine, simply interrupt the power with the transformer throttle or the transformer directional switch and enter forward or reverse.

## PROTO-COUPLER™ OPERATION

Your NYC 4-6-0 ProtoSound® equipped locomotive tender is equipped with a coil-wound ProtoCoupler™ for remote uncoupling action. Because the ProtoCoupler™ is controlled through ProtoSounds® microprocessor, it doesn't require an uncoupling track section or modification to your layout to function. The three simple steps below are required to operate the coupler.

1. Put your engine in NEUTRAL and turn the throttle all the way up.
2. Press the transformer whistle button to "Arm" the coupler. (You will hear a "Clank").
3. After arming the coupler, press the whistle button again to open the coupler.

When the knuckle fires open you will hear the buzzing of the coil energizing and the sound of the air lines coming apart. It can best be described as a **CHA-CHUSHHH** sound.

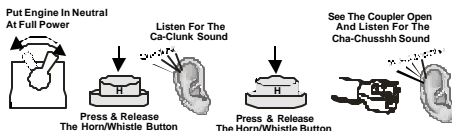

The coupler doesn't have to be fired in NEUTRAL. Once the coupler is armed it can be fired in Forward, Neutral or Reverse. However, you may find that the coupler doesn't open when firing the coupler at high speeds. Reduce the voltage setting on your transformer if this occurs and run your engine at a slower speed before firing the coupler. If the coupler continues to open erratically, try lubricating the knuckle with light oil as indicated in Fig. 5.

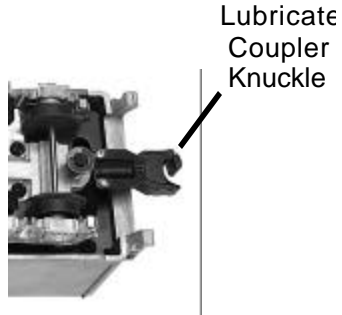

Figure 5: Lubricating The Coupler

### ENHANCED NEUTRAL STEAM SOUNDS

The enhanced Neutral Sounds can be automatically heard whenever the engine is in neutral. The sounds, which include Steam Pop-Off, Steam Blow-Down, and Steam Injector sounds occur every 2 to 30 seconds. Each of the three sequences will play at random intervals to eliminate repetitive and boring sequences. While the sounds are selected to play randomly by the microprocessor, there is no guarantee that you won't hear the same message repeated twice or more times.

### SQUEAKING BRAKE SOUNDS

ProtoSound® equipped engines feature the ability to play the sound of squeaking brakes whenever your engine slows in speed. There are two settings for activating the squeaking brake sounds. The default setting allows the brake sounds to play while the engine is in forward or reverse and the transformer throttle is lowered from a high setting to a low setting (14 volts to 8 volts or less). The second setting requires that a bell button be used to "arm" the brake feature and is explained in more detail in the "Activating Freight Yard Sounds" section found later in this manual. The sound itself is a stored record on the ProtoSounds® software chip and will always play the same brake

Throttle Down From High Voltage To Low



Listen For The Squeaking Brake Sounds

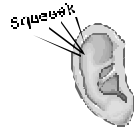



sound for the same three second length each time the voltage is reduced from high to low. Some practice may be required to synchronize the playing of the brake sounds with the movement of the engine. It is not uncommon for the engine to stop before the brake sound is completed. Operators will find that by coordinating the movement of the throttle setting from 8 volts to off will allow the engine to maintain its movement while the brake sounds play. *Note: The brake sounds will not be heard if the transformer throttle is not set above 14 volts and/or not reduced below 8 volts.*

### **TIPS ON USING THE SQUEAKING BRAKE FEATURE**

Users will find the squeaking brake feature to be a very realistic way to simulate the sound of an engine slowing down for curves, crossings or coming to a stop at a station, side track or switch yard. However, you may find that your engine continues to play the brake sounds once your engine comes to a stop, or that the sounds stop before the engine comes to a complete halt. For example, if you simply run the engine and turn the throttle off quickly, the brake sounds will likely continue playing even though the engine has come to a complete stop.

This effect can be eliminated by simply practicing with the brake feature. In no time, you will quickly learn how to "feather" the throttle to keep the engine moving while the brake sounds play and then turning the throttle off just as the sounds stop.

# Operating Proto-Sound Freight Yard Sound Effects *Freight Yard Sounds (FYS)*

Proto-Sound® is equipped with operator controlled Freight Yard Sounds, referred to as FYS. The FYS sequence is designed to simulate the arrival, unloading, loading and departure of a freight train in a freight yard. This easy-to-use feature allows you to play digitally recorded sounds of freight yard operations while your engine is parked in the Neutral State. No additional wires or modifications are needed to enjoy these amazing sound effects. The sounds themselves are randomly “shuffled” by the Proto-Sound® computer. This gives the system the ability to play the various sounds in a different order each time FYS is enabled.

## Quick Overview- FYS Sounds

The following is a quick over view on how you can operate FYS.

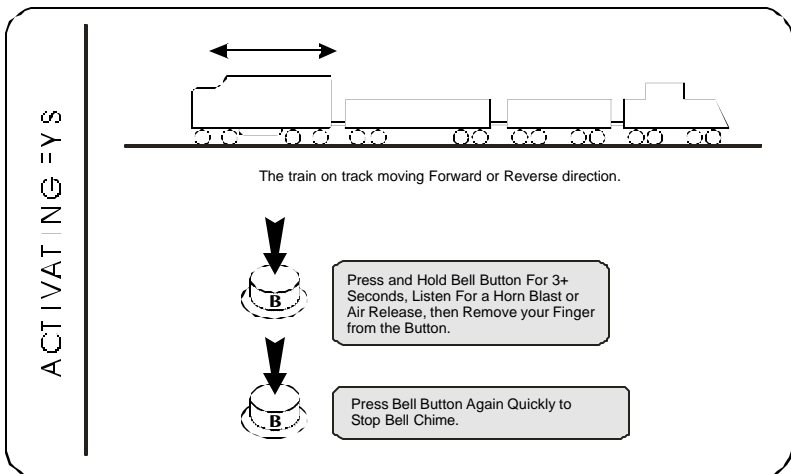

Your train is now ready for you to play the FYS.

**EVENT 1**

OR

- ◆ To Play FYS, Stop Train Direction. This Can Be Done by Pressing the DIRECTION Button or Cycling the Transformer Handle.
- ◆ At This Time the Train Will Stop in Neutral.
- ◆ In a Few Seconds, A Man Whistling Plays, Followed by a Background Noise.

**EVENT 2**

OR

- ◆ Change/Press Direction- The Train Will Remain In Neutral. It Will Continue to Play More Background Noises.

**EVENT 3**

OR

- ◆ Change/Press Direction- The Train Will Remain In Neutral. You Will Hear a Double Air Release, A Man Whistling Plays, More Background Noises.

**EVENT 4**

OR

- ◆ Change/Press Direction- The Train Will Remain In Neutral. You Will Hear Closing Doors, Horn Blast, a Few Bell Chimes and Engine Departs in the Direction the Engine First Stopped.

For more detailed FYS instructions, read the following.

## Activating Freight Yard Sounds (FYS)- Detailed Instructions

### *Arming The Freight Yard Sounds Feature*

Before the Freight Yard Sounds can be heard, the feature must be activated. The feature can be activated in one of two ways:

**Option 1:** If you are using the Z-4000™ transformer, or any transformer with a separate bell button controller, you can activate the feature by simply pressing and holding the bell button for at least three seconds (it does not matter if you are in forward, neutral or reverse). You will hear the bell turn on and, after three seconds, you should hear a short horn blast or air release.

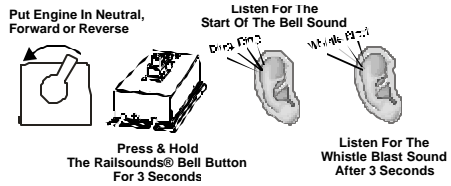

Once the horn blast or air release is heard, the bell button can be released. The bell will continue to chime, so if you want to turn off the bell ringing, simply press and release the bell button. If you were in neutral, interrupt the transformer throttle to enter the next directional state (either forward or reverse). (**Note: the FYS will only play in the first Neutral after it is armed. You cannot interrupt the power twice to enter another direction and still have the FYS active.**) You can now trigger the sounds to begin playing when you next enter Neutral

**Option 2:** If you do not have a Z-4000™ (separate bell button available), you can activate the FYS using your transformer’s whistle button control. To arm the FYS, turn on the transformer throttle and cycle your engine into Neutral (not RESET). Once

in neutral, set the transformer throttle to 8 volts or less and press and hold the whistle button for at least three seconds. You will hear the bell turn on and, after three seconds,

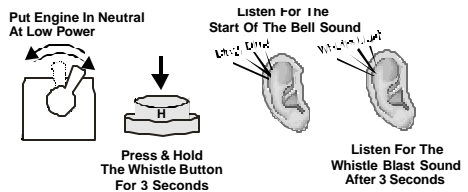

you should hear a short horn blast. Once the horn blast or air release is heard, the whistle button can be released. The bell will continue to chime, so if you want to turn off the bell ringing, simply press and release the

whistle button. Interrupt the transformer throttle to enter the next directional state (either forward or reverse). (*Note: the FYS will only play in the first Neutral after it is armed. You cannot interrupt the power twice to enter another direction and still have the FYS active.*) You can now trigger the sounds to begin playing when you next enter Neutral.

## TRIGGERING FREIGHT YARD SOUNDS

Once the FYS feature has been activated, it will be played the next time the engine enters neutral. At this point, Proto-Sound® will take over control of your engine, disabling the bell and whistle button. In addition, Proto-Sound® reconfigures the way the reverse unit functions during the operation of the FYS feature. This forces the engine to leave your freight yard in the same direction as it arrived. The following operator controlled “Events” control the FYS’s actions and sounds. (*Note: The direction states shown assume the FYS is entered from forward. If entering the freight yard in reverse, the direction states shown will be reversed.*)

**Event 1:** Interrupt the transformer throttle to cycle the engine from forward into neutral. If the throttle was at 14 volts or higher, the squeaking brakes sound will play. Once the engine is stopped, the throttle must be turned on to keep it in the neutral state. *Note: Failure to turn the throttle back on within 3 seconds of*

*leaving forward will disable FYS and shutdown Proto-Sound®. The next time power is turned on, the engine will be in the RESET position. See page 19 for additional information on RESET.* If the bell was not turned off after arming FYS, it is now turned off automatically. After entering neutral, Proto-Sound will immediately play a horn blast or an air release sound, followed approximately 2 seconds later by a man whistling and a freight car door sliding open. At this point, various freight yard sounds can be heard, including loading and unloading operations, engine sounds, yardman “slang,” and additional freight car door sounds.



**Event 2:** Interrupt the transformer throttle again to cycle the engine from neutral into reverse. In order to have the engine leave the yard in the same direction it entered Proto-Sound® disables the motors in this reverse state to prevent the engine from running backwards. FYS confirms reverse is entered by playing a sound highlight best described as a rumbling sound.

You may have to go through the entire FYS sequence several times before you clearly identify this sound. After the rumbling highlight is played, the freight yard sounds heard in Event 1 will continue to play.

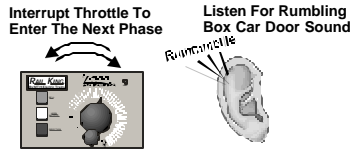

**Event 3:** Interrupt the transformer throttle again to cycle the engine from reverse back to neutral. FYS confirms that the engine is now in neutral by sounding two quick air releases. This is followed approximately two seconds later by a man whistling and continued freight yard loading and unloading sounds.

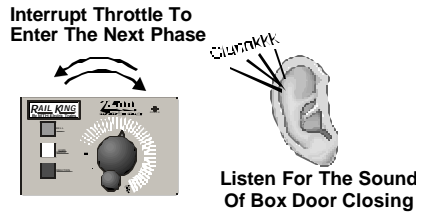

**Event 4:** Interrupt the transformer throttle again to complete the FYS feature and cycle the engine into forward. FYS confirms it has entered forward by playing the sound of the freight car door closing. Within two seconds, the whistle will sound two short blasts (three if entering reverse), and the bell will begin to chime. After a few chimes of the bell, the engine will begin moving in forward with the bell continuing to ring. A few seconds later, the bell will turn off, and the engine will resume normal operation.

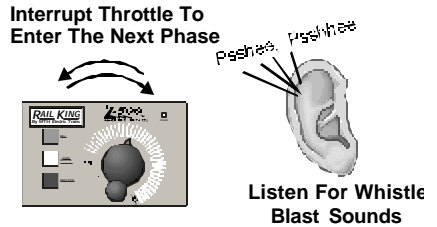

**Note:** *When entering the Forward phase of FYS, it is important to set the transformer throttle at a high enough setting that will allow the engine to begin moving once FYS automatically activates the motors. Otherwise the engine will just sit still until you increase the transformer throttle setting on the transformer. However, don't set the throttle setting too high or the engine will go racing away faster than you might expect*

# TIPS ON USING FYS FEATURES

FYS is a unique feature of Proto-Sound® that is completely controlled by the operator. You decide how, when or if you want to utilize the feature. By reviewing the following tips, you should find solutions or suggestions to the various operating scenarios you might encounter when using FYS.

**Tip #1:** You can escape the FYS sequence by interrupting the transformer throttle before the man's whistle plays in Stage 1 (neutral).

**Tip #2:** You can exit FYS at anytime by turning the transformer throttle Off for 15 seconds.

**Tip #3:** You do not have to be in Forward to utilize FYS. For example, if you activate the FYS feature while in Reverse your train to leave the station/yard in the same reverse direction that it arrived in.

**Tip #4:** You can use FYS even if you are double-heading with another engine regardless of whether the second engine is equipped with an FYS programmed Proto-Sound® module. If the second engine isn't equipped with FYS, the only thing to remember is not to turn up the transformer throttle very high when entering Reverse in Stage 2. If the throttle is set too high, then the second locomotive will begin vibrating on the track as its motors will be turning in reverse. If your second engine is equipped with FYS, you may want to disable the FYS when used in double-headed operations. To disable FYS, see the section on programming RESET functions on page 22 of this manual.

**Tip #5:** You can leave any of the event stages at any time by simply interrupting the transformer throttle. Any sound effects programmed to play in that event will simply not occur. The only exceptions are Event 1 and Event 4. In Event 1, interrupting the throttle has no effect on FYS until after the man's whistle has completed and the freight car doors have opened. In Event 4, you cannot interrupt FYS until after the engine begins to move. Interrupting the throttle before the engine begins to move has no effect on the locomotive's operation.

# Special Reverse Unit Options

## *Reverse Unit Lockout Operation*

For operators who wish to lock their engine into a single direction, Proto-Sound's® unique design eliminates the need for a lock-out switch on the locomotive. This will allow users to run the engine on layouts equipped with block signals or stop stations that would normally cycle the engine back into neutral. **Note: The feature must be first turned on by accessing RESET Feature 40 (See page 23).**

## *Locking the Engine into Single Direction Operation*

Cycle the transformer throttle so that your engine is operating in the direction you wish to lock it in (forward, neutral or reverse). With the throttle set to approximately 8 volts, press and hold the horn/whistle button. While holding the horn/whistle button, turn the throttle OFF, then release the horn/whistle button. After 2 seconds, you will hear a short whistle blast. IMMEDIATELY turn the throttle back on. The engine is now locked, and will continue in the previous direction whenever power is applied to the track.

## *Unlocking the Engine*

With the throttle set to approximately 8 volts, press and hold the horn/whistle button. While holding the horn/whistle button, turn the throttle OFF, then release the whistle button. After three seconds, a single bell will be heard indicating that the engine is unlocked. When power is again applied, the engine will enter RESET and perform as normal.

**NOTE: When locking the engine in the Forward or Reverse positions, the horn/whistle button will blow the horn/whistle. But when locking the engine into the NEUTRAL position, the horn/whistle button may turn on or off sounds of the bell. Remember, the horn/whistle doesn't blow in NEUTRAL (unless you programmed it to do so using Reset Feature 25 - see page 20 for details), only the bell rings.**



# SELF-CHARGING BATTERY BACKUP

Proto-Sound® includes a self-charging battery backup system for improved performance at any speed. The battery ensures that power to the sound system will remain on during directional changes, while setting RESET options or when traveling over spots of dirty track and switches. The self-recharging battery backup system is automatically turned on or off. There no switches needed to enjoy the benefits of the automatic battery backup system.

Proto-Sound® contains a warning alarm if the battery backup system fails to automatically disengage when track power is turned off. Should the backup system fail, you will hear a repeating whistle blast indicating that this has occurred. Should this happen, unplug the battery from the Proto-Sound® module (to prevent the battery from being run down) and contact MTH for instructions on returning the train for repair.

## REPLACING THE PROTOSOUND® BATTERY

The Proto-Sound® battery (located in the tender body), is a special NiCad 7-cell, 8.4v battery -NOT the 6-cell, 7.2v battery found in most convenience stores. The battery is continually charged from the track when power is applied above 10 volts should last for up to five years. In addition, the NiCad battery is a dry battery and should not leak or cause any damage to your locomotive during its lifetime. The 6-cell NiCad is NOT recommended for use with Proto-Sound® applications.

If you notice that the sounds seem distorted or garbled at low voltages or become silent when power from the transformer is shut off, the battery may be failing. Before replacing the battery, you should put the engine in NEUTRAL and leave the transformer throttle set at about 12 volts for 15 minutes. This should temporarily recharge the battery. If the garbled or distorted sounds are reduced, then your battery charge has worn down. You can give your battery a full charge by leaving the engine ON in the NEUTRAL position for 6 hours.

***Note: When charging the battery in neutral, if your trains contains a Smoke Unit should be turned OFF to prevent damage to the wick and the heating elements.***

If you need to replace the battery, they are available from MTH Proto-Sound® Electronics at 7020 Columbia Gateway Drive, Columbia, MD 21046-1532. A standard 9v alkaline battery can be substituted as a temporary fix, but, since alkaline batteries can't take a charge, it will eventually wear down.

**MANUALLY ADJUSTING THE PROTO-SOUND® VOLUME**

Your Proto-Sound® system has two types of volume adjustment. A manual turn knob on the bottom of the chassis (See Fig. 6 below) allows you to control all the sounds in the system and a remote control “RESET” option (Option # 6) allows you to control the volume level of the engine chuff sounds remotely from the transformer. Turning the volume adjustment knob one direction will increase the volume. Turning it the opposite direction will lower the volume of all sounds: bell, whistle, and enhanced neutral sounds. For information on operating the RESET volume adjustment option, see the section entitled “Programming Proto-Sound® RESET Options” on the following pages.

**USING “RESET” TO PROGRAM PROTO-SOUND®**

Proto-Sound® is equipped with several programmable features which are accessed in the RESET state by moving the transformer throttle up and

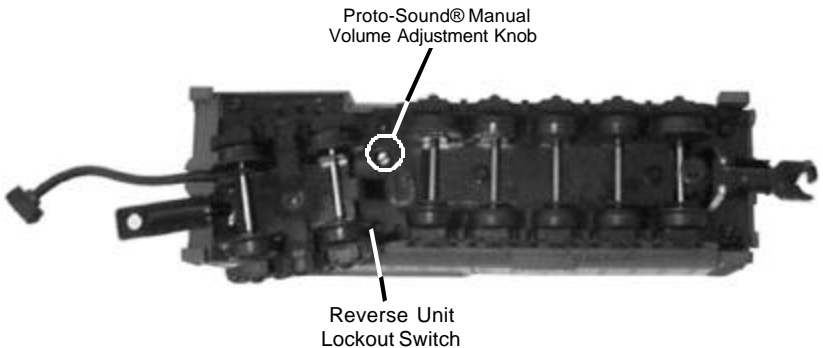

*Figure 6: Adjusting The ProtoSound® Volume*

down between full voltage and low voltage (8 volts) without shutting the transformer off completely. Each time this is done you advance, one feature at a time, through the available options. An air-release sound is heard each time the throttle is advanced and returned. In addition, there are special sounds to tell you what RESET position you are in.

## ENTERING RESET OPTIONS

For example, if you want to select Feature 2, you put the engine in RESET, and move the throttle up and down from full throttle to low two times.

After the second advance, you will hear two “clinks”

indicating that the computer is now in Feature 2. Advance the throttle again and you will hear three “clinks” for Feature 3. Advance it two more times and you will hear a “clank” indicating that you are now in Feature 5.

Advance the throttle two more times and you will hear a “clank” and two “clinks” indicating Feature 7. ((5 throttle advancements = 1 clank) + (2 throttle advancements = 2 clinks)). “Clank + “Clink” + “Clink” = Feature 7. You can advance the throttle as quickly as you like (though you may not hear the air-release sounds) and the computer will still remember the number of times the throttle is advanced by playing back the number of “Clinks” and “Clanks” to confirm the feature you’ve selected.

### **Remotely Adjusting The Engine Volume - *Reset Feature 6 - (1 Clank, 1 Clink)***

Reset Feature 6 allows you to change the volume setting of the chuff sounds without affecting the volume of other sounds, such as whistle, bell,

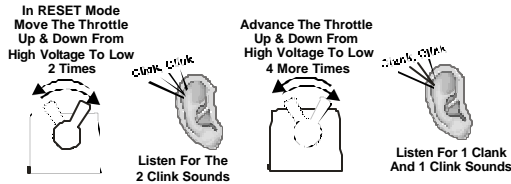

enhanced neutral sounds, etc. To use, cycle to Reset 6 and press the Whistle button. A single bell will play, and the chuff will begin at the current volume. Each time the Whistle button is pressed, a bell will sound and the volume setting will cycle down to the next level. The levels available are 100%, 50%, 25%, and 0%. After 0%, pressing the whistle button again will return the chuff to 100%. When the desired level is reached, lock the changes by interrupting the throttle and cycling the engine into forward

**Programming For Squeaking Brake Operation- Reset**

*Feature 45 -(9 Clanks, 0 Clinks)*

Reset Feature 45 allows you to determine if and

how the Squeaking Brakes recording will be activated. To use, cycle to Reset 45 and press the Whistle button. The engine will play a series of bells. This indicates the current setting. Each time the Whistle is pressed, Proto-Sound® will cycle to the next available setting and provide the appropriate bell indicator. The settings for Reset 45 are 1 Bell = On Demand (Enabled when FYS is activated), 2 Bells = Always On, 3 Bells = Off. When the desired setting is reached, lock the changes by interrupting the throttle and cycling the engine into forward.

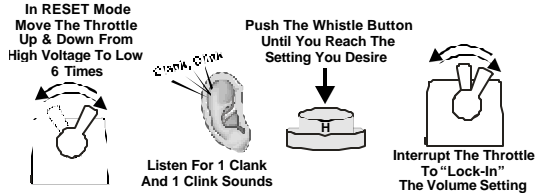

**Programming For Whistle In Neutral Operation- Reset**

*Feature 25 -(5 Clanks)*

Reset Feature 25 allows you to operate the Horn while the engine is in the Neutral state. When ON, pressing the Horn/Whistle button while in Neutral, with 10V AC or less on the track, will cause the

Horn recording to sound. To use, cycle to Reset 25 and press the Horn/Whistle button. The engine will play a series of bells. This indicates

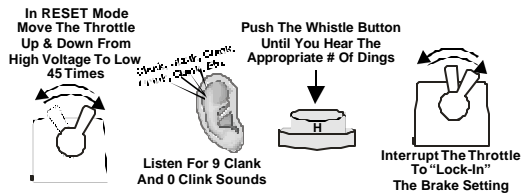

the current setting. Each time the Horn/Whistle button is pressed, Proto-Sound® will cycle to the next available setting and provide the appropriate bell indicator. The settings for Reset 25 are 1 Bell = OFF, 2 Bells = ON. When the desired setting is reached, lock the changes by interrupting the throttle and cycling the engine into forward.

## Programming For Proto-Coupler® Operation - *Reset Feature 10-(2 Clanks)*

Reset 10 allows you to turn the operation of the Proto-Coupler® on or off. When OFF, the coupler will not arm or fire from Neutral. To use, cycle to Reset 10 and press the Whistle button. The engine will play a series of

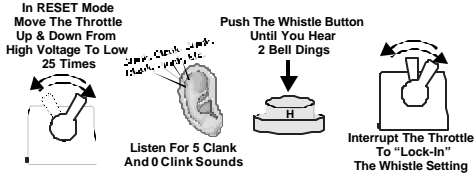

bells. This indicates the current setting. Each time the Whistle button is pressed, Proto-Sound® will cycle to the next available setting and provide the appropriate bell indicator. The settings for Reset 10 are 1 Bell = ON, 2 Bells = OFF. When the desired setting is reached, lock the changes by interrupting the throttle and cycling the engine into forward.

## Adjusting Chuff Rate - *Reset Feature 27 - (5 Clanks, 2 Clinks)*

Reset Feature 27 allows the operator to “fine tune” the rate of chuff relative to the speed of the engine by setting the minimum and maximum chuff points. To do this with the MTH Z-4000, follow the steps below:

1. With the steam engine on the track, and the transformer throttles in the “OFF” position, press the “PROGRAM” button for the track in use. The display will read “00” and “PG”.

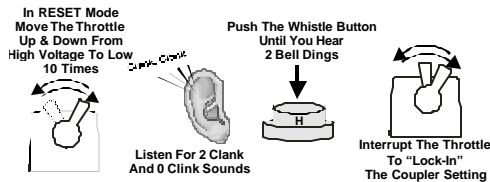

2. Using the “WST/HRN” button, scroll the top display up to “27,” then press “BELL SELECT.” The transformer will power the engine in Reset, and run the Proto-Sounds® to Reset Feature 27 (5 Clanks, 2 Clinks).
3. Raise the throttle from the “OFF” position and press the “PROGRAM” button. This will release the transformer from the Program Mode without the engine leaving Reset Feature 27.
4. With the throttle set low, press the “WST/HRN” button. You will hear a single bell, and the engine will begin to move forward with no chuff.
5. Reduce the throttle until the engine just stalls, and press “WST/HRN.” You will hear a double bell. This is the motor speed where the chuff will begin.
6. Raise the throttle until the engine is running at the speed that you want the chuff to be the fastest, and press “WST/HRN”. You will hear 3 bells, and the engine will stop.
7. Bring the throttle to the “OFF” position to complete the Reset Feature.

Test the settings by running the engine. You may need to repeat the procedure to further adjust the thresholds. And remember you can always return to the Default Settings by using Reset Feature 18.

*NOTE: Special note for steam engines only. Once you have reached reset 18 you have two options. Option 1 resets all the reset features except for reset feature 27 (Chuff Rate) back to the default setting. Option 2 resets all reset features back to the default setting. For Option 1, press the horn/whistle button once after you have heard the 3 clanks and 3 clicks this will reset all the reset features except reset 27 (Chuff Rate) back to the factory settings. For Option 2, press the horn/whistle button again you have now reset the remaining reset feature 27 (chuff rate) back to the factory setting. All the reset features now have been set back to the factory settings*

### **Programming FYS Operation - Reset Feature 28-(5 Clanks, 3 Clinks)**

Reset Feature 28 allows you to turn the operation of the FYS sequence on or off. When OFF, the FYS will not activate. To use, cycle to Reset 28 and press the Horn/Whistle button. The engine will play a series of bells. This indicates the current setting. Each time the Whistle button is pressed, Proto-Sound® will cycle to the next available setting and provide the appropriate bell indicator. The settings for Reset 28 are 1 Bell = ON, 2 Bells = OFF. When the desired setting is reached, lock the changes by

interrupting the throttle and cycling the engine into forward.

## Activating Remote Lock-Out Control - Reset Feature 40-(8 Clanks, 0 Clinks)

Reset Feature 40 allows you to enable the Reverse Unit

Lockout feature of Proto-Sound®. When enabled, you are able to lock the engine to run in only one of the directional states (Forward, Neutral or Reverse) whenever power is applied. The most common use for locking out an engine is in the use of power

blocks on a layout. To use, cycle to Reset 40 and press the Whistle button. The engine will play a series of bells. This indicates the current setting. Each time the Whistle button is pressed, Proto-Sound® will cycle to the next available setting and provide the appropriate bell indicator. The settings for Reset 40 are 1 Bell = OFF, 2 Bells = ON. When the desired setting is reached, lock the changes by interrupting the throttle and cycling the engine into forward.

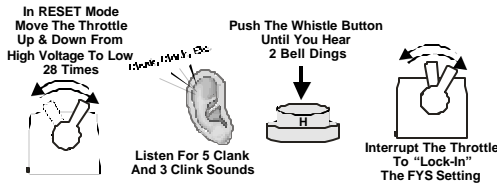

## Resetting All Proto-Sound® Options To Factory Defaults - Reset Feature 18 -(3 Clanks, 3 Clinks)

Reset Feature 18 is the most powerful of the Reset features available. Using Reset Feature 18 allows you to override all changes in programming and return all Resets to the original, out of the box settings. To use, cycle to Reset Feature 18 and

press the Horn/Whistle button. The engine will play a distorted bell, followed by a clear bell sound. This indicates that the Proto-Sound system has restored all settings to factory default settings. Lock the changes by interrupting the throttle and cycling the engine into forward.

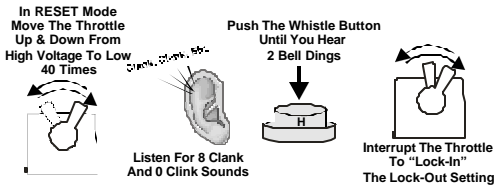

# OIL & LUBRICATION INSTRUCTIONS

In order for the engine to perform correctly and quietly, it is important that the chassis be lubricated before operation. Lubrication should include all side rods and linkage components and pickup rollers to prevent them from squeaking. Use light household oil and follow the lubrication points marked "L" in Fig. 8 below.

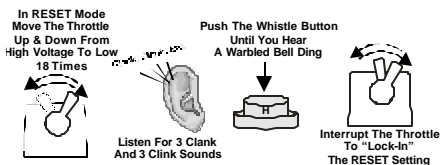

The locomotive's internal gearing has been greased at the factory and shouldn't need additional grease until after 50 hours of operation or one year whichever comes first. Grease can be added by inserting grease into the gear box inside the locomotive chassis. In order to access the gear box, the boiler must be removed from the chassis by unscrewing the four chassis screws as seen in Figure 10 on this page. Once the boiler is removed, the gear box can be opened up by unscrewing the two screws on the plate located in front of the motor. Grease can then be applied into the gear box using a grease tube dispenser.

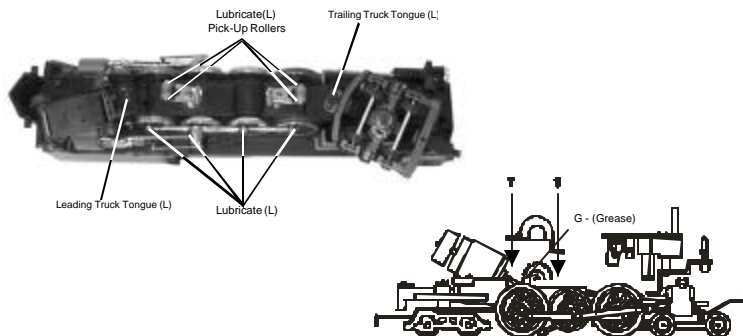

Figure 8: Lubricating The Locomotive Chassis

In addition to the internal gearing, it is a good idea to lubricate the leading and trailing locomotive truck "tongues" to enhance their ability to slide on the chassis. Follow the grease points as seen in Figure 8 on page 24. Follow Figure9 on page 25 to lubricate the tender.



Periodically, check the locomotive wheels and pickups for dirt buildup as this can significantly affect the engine's ability to perform properly. Dirty track and dirty wheels can cause both poor electrical contact as well as poor traction, especially on elevated track sections. Finally, dirt and oil build up can prematurely wear out the neoprene traction tires.

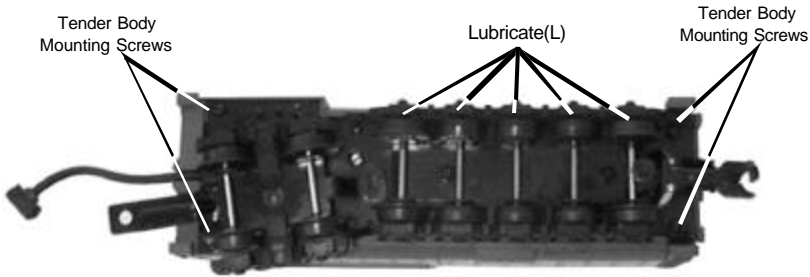

Figure 9: Lubricate The Tender Chassis Trucks

## TRACTION TIRE REPLACEMENT INSTRUCTIONS

Your locomotive is equipped with two neoprene rubber traction tires on the rear set of flanged drivers. While these tires are extremely durable and long-lasting there may arise a time where they will need to be replaced. Should this occur, you will need to remove the side rods from the wheels in order to slip the new tire over the grooved drive wheel.



Figure 10: Removing The Boiler From The Chassis

Before the new tire can be installed, you must make sure the old tire has been completely removed from the groove in the drive wheel. Use a razor blade or small flatblade screwdriver pry away any remains left from the old tire that may still be in the drive wheel groove. Once the old tire has been completely removed, slip the new tire onto the wheel. You may find it useful to use two small flatblade screwdrivers to assist you in stretching the tire over the wheel. Be careful to avoid twisting the tire when stretching it over the wheel. If a twist occurs, the tire will have to be removed and reinstalled or a noticeable wobble in your engine will occur when operating the locomotive. In addition, it is important to make sure that the tire is fully seated inside the groove. Any portion of the tire extending out of the groove can cause the engine to wobble. A razor blade can be used to trim away any excess tire that doesn't seat itself inside the groove properly. Replacement tires are available directly from MTH Electric Trains.

## **HEADLIGHT REPLACEMENT**

The locomotive's headlights are controlled by the track voltage and will glow with greater intensity depending on the transformer voltage setting. The headlight can be easily removed from its lampholder should the bulb expire. To remove the bulb, follow the boiler removal instructions found in the Lubrication section on the proceeding pages. Once the cab has been separated from the chassis, gently unscrew the bulb from its socket. Replacement bulbs are available directly from MTH Electric Trains.

# TROUBLE SHOOTING *PROTOSOUND*® PROBLEMS

Although ProtoSound™ has been designed and engineered for ease of use, some questions may arise during initial operation. The following table should answer most questions. If you find that your problem can't be resolved with this manual, contact MTH ProtoSound Electronics (7020 Columbia Gateway Drive, Columbia, MD 21046, 410-381-2580) for additional assistance.

<b>WHISTLE PROBLEMS</b>	<b>REMEDY</b>
The WHISTLE seems distorted at low voltages.	Your battery may be undercharged or dead. Try recharging the battery as explained in the battery sections.
When I press the whistle button, the bell comes on instead.	You are trying to operate the whistle in neutral. The whistle will only operate in Forward or Reverse unless you program ProtoSounds through Feature 25. See the instructions in the section entitled "Using RESET to Program ProtoSounds".
I can't get the whistle to blow when I press the whistle button.	You may be pressing the whistle button too quickly. Most older AC transformers contain a two-step whistle button that releases a DC signal onto the track. It is this DC signal that tells the whistle to blow. However, because the signal is weaker when the whistle button is depressed fully, the ProtoSound circuit may not recognize the signal. Try pressing the whistle button slower, taking approximately 1 second to fully depress the button.
<b>BELL PROBLEMS</b>	<b>REMEDY</b>
When I press the whistle button to activate the bell, the whistle sounds.	You are trying to ring the bell in Forward or Reverse. The bell only operates in Neutral unless you have programmed ProtoSounds to recognize a separate bell button.
When I press the whistle button to activate the bell, I arm the coupler.	Reduce the voltage on the transformer before pressing the whistle button to activate the bell. The bell will only come on at 8 volts or less.
When I press the whistle button to activate the bell, the bell only rings once.	You are trying to ring the bell in RESET instead of neutral. Interrupt the power twice to enter Neutral, set the voltage at 8 volts or less and press the whistle button to activate the bell.
I can't get the bell to ring when I press the whistle button.	You may be pressing the whistle button too quickly. See the 3rd remedy in the whistle section above.
The bell won't work with a separate bell button.	ProtoSounds must be programmed in order for a separate bell button to function. Enter RESET function number 20 (see the section entitled "Using RESET to Program ProtoSounds") and press the whistle button until the bell sounds two dings. Simply turn the throttle off and then on again to lock in the new setting.

<b>COUPLER PROBLEMS</b>	<b>REMEDY</b>
The ProtoCoupler won't let the engine uncouple on the "Fly".	The power required to fire the coupler open when the engine is on the "Fly" may be greater than the ProtoSound system is capable of providing. As a result, you may experience times when the coupler won't fire open. Unfortunately, the only solution is to stop the engine and fire the coupler in Neutral. If that doesn't resolve the problem, try lubricating the coupler knuckle and rivet as explained in the ProtoCoupler Operation section.
I can't get the coupler to arm or fire open when I press the whistle button.	You may be pressing the whistle button too quickly. See the third remedy in the whistle section above. Another possibility is that ProtoSounds has been programmed to turn the coupler function off. See the section entitled "Using RESET to Program ProtoSounds"
Only one coupler will function when I press the whistle button.	Only one coupler can operate at any one time. Use the coupler selection switch on the bottom of the chassis to choose which coupler you want active.
<b>LOCKOUT PROBLEMS</b>	<b>REMEDY</b>
I can't get the engine to run after I power up the transformer. It sits still with the steam compressor sounds running.	The engine is locked out into the Neutral position. Follow the unlocking procedures in the Lockout Section.
The engine won't lock out into Forward, Neutral or Reverse even after the short whistle blast sounds.	You are waiting too long to turn the throttle back on after the short whistle blast sounds. The power must be turned back on immediately after the short whistle blast sounds or the engine will go back into RESET. See the lockout procedure in the Lockout Section.
<b>VOLUME PROBLEMS</b>	<b>REMEDY</b>
When I try to run the engine, the steam volume is OFF or very low.	The steam volume has been programmed at a reduced volume or to be silent. Go to RESET Feature 6 and adjust the volume. See the section entitled "Using RESET to Program ProtoSounds" for more information.
When I try to set the steam volume, it resets itself to the original volume after I selected the new volume.	You are trying to set the volume with a poorly charged or dead backup battery. See the section on Battery Backup for more information.
When I try to set the Steam Volume to O Volume, I still hear the cab chatter sounds.	When the steam volume is set to O, you will hear the Cab Chatter sounds because setting the steam volume only controls the sound of the steam engine itself. All other sounds, including Cab Chatter, the whistle and bell will continue to play at the volume level set by the manual volume control knob located on the bottom of the chassis. See the section entitled "ProtoSound Volume Adjustment" for more information.
The sounds seem distorted, especially when the whistle or bell is activated.	The overall ProtoSound volume has been set to high creating the distorted sounds. Try turning the volume control knob located on the bottom of the chassis counter clockwise to reduce the overall volume level.

<b>BATTERY PROBLEMS</b>	<b>REMEDY</b>
I get no sounds when the engine shifts between the direction states.	The battery may be dead or needs charging. See the Battery Backup section for more information.
After I turn off my transformer, my engine continues to make sounds before quitting with a ding of its bell.	ProtoSounds continues to sound for approximately 10 seconds after power to the track has been shut off.
The sounds distort at low voltages.	The battery is insufficiently charged or dead. Follow the recharging instructions found in the section entitled "Self Recharging Battery Backup System".
A repeating whistle blast occurs after the power has been shut down.	The battery is insufficiently charged or dead. Follow the recharging instructions found in the section entitled "Self Recharging Battery Backup System".
<b>RESET PROBLEMS</b>	<b>REMEDY</b>
When I first turn the power on, the engine will not begin to run. I have to turn the throttle off and then on again to get the engine to operate.	This is normal behavior. When power to the track is first turned on, ProtoSounds enters a "RESET" phase at which time the engine undergoes a system check. Power must be interrupted to get the engine into the Forward Phase. See the section entitled "DCRU Reverse Unit Operation" for more information.
Whenever I interrupt the power from RESET to enter Forward, the engine goes back into RESET instead of Forward. I know this occurs because the bell dings twice.	Whenever ProtoSounds enters RESET after power has been off for more than 15 seconds, the microprocessor initiates a system check to determine that everything is in working order. This system check requires 2.2 seconds to complete during which time the engine will play the steam startup sounds. We recommend that you don't interrupt the power in RESET until the steam startup sounds have completed. This will guarantee that the system check will have been completed since the startup sounds take longer than 2.2 seconds to play. If the problem persists, we recommend that you operate the throttle with a slower movement as you interrupt the power in RESET and enter the Forward Phase
<b>BRAKE SOUND PROBLEMS</b>	<b>REMEDY</b>
When the transformer is throttled down, the sounds won't play.	The brake feature has not been activated. See the section on activating the brake feature for more information. The throttle voltage setting on the transformer is either not starting high enough or ending low enough to trigger the brakes sounds. Try increasing the throttle setting to 14 volts or higher before throttling down to 8 volts or less.
The brake sounds continue to play even after the engine stops.	The brake feature sound record lasts for three seconds. With practice you can control how quickly you should stop the engine to keep it in sequence with the sound of the brake's squeaking.
The brake feature was activated in neutral after the engine was running in forward, but the brake sounds would not play when triggered after the engine went back into forward or reverse.	The brake feature will only remain enabled if it is triggered in the first direction state you enter after activating the feature in neutral. You cannot interrupt the power twice to enter another direction state and still have the brake feature active. Therefore, in order to make the brake sound feature operate in forward, you must first activate the feature in the neutral position that occurs after the engine was in the reverse state.

After triggering the brake sound and stopping the engine in neutral, the engine begins making passenger station sound effects.	After you trigger the brake sounds, you cannot stop the engine in neutral and leave the track power on without activating the passenger station sounds. If you don't want to hear the passenger station sounds after entering neutral, turn the power off for three seconds to disable the passenger station sound effects.
<b>FYS PROBLEMS</b>	<b>REMEDY</b>
The FYS feature does not begin even after stopping the engine and hearing the brake sounds.	The power was not turned back on once the engine enter the neutral state thus disabling FYS. The transformer throttle was interrupted too quickly in neutral thus disabling FYS. Leave the throttle on in neutral until after the FYS arrival message plays.
The FYS sound effects occasionally repeat themselves.	ProtoSounds has a built-in random number generator that randomly selects each sound clip to play. Because there are only a total of 8 sound clips available in each FYS event, it is probable that a sound can occasionally be repeated one or more times.
Once in FYS, the engine never goes in reverse.	So that the freight yard sound effects and operation is as realistic as possible, ProtoSounds disables the reverse unit state whenever FYS is enabled. This way the engine never goes into reverse as the operator cycles through the various FYS events.
When the engine enters FYS event 5, the bell automatically comes on.	FYS has a built-in command to turn on the bell when the system enters Event 5. After approximately 15 rings of the bell, it automatically will turn off.

## PROTOSOUND RESET FEATURE CHART

The following chart lists the available features found in your ProtoSound equipped engine. The default settings are listed for each feature as well as the operation of the feature. You can reset all features to their original factory settings by accessing Feature 18 in RESET and then pressing and holding the transformer whistle button until you hear a soft, warbled bell sound.

RESET #	OPERATION	DEFAULT	CLANKS/CLINKS
6	Engine Volume	Full Volume	1 Clank/1 Clink
10	Coupler ON/OFF	Coupler ON	2 Clanks/0 Clinks
18	Reset Default Settings		3 Clanks/3 Clinks
20	Remote Bell Button	Bell Button Active	4 Clanks/0 Clinks
23	RESERVED	RESERVED	
25	Whistle In Neutral	Whistle In Neutral OFF	5 Clanks/0 Clinks
27	Chuff Rate	Full Chuff Range	5 Clanks/2 Clinks
28	FYS Enabled	FYS ON	5 Clanks/3 Clinks
40	Lockout Enabled	Lockout OFF	8 Clanks/0 Clinks
45	Squeaking Brakes	Brakes Always ON	9 Clanks/0 Clinks

# TRANSFORMER COMPATIBILITY AND WIRING CHART

ProtoSounds® is designed to work with any standard AC transformer that uses a “Pure Sine-Wave” format. The chart below lists the many Lionel® compatible transformers, such as the Lionel KW or ZW models. In addition, the chart details how the terminals on these compatible transformers should be attached to your layout. The Trainmaster system from Lionel® will not function correctly with ProtoSounds® without disrupting the sound effects. Therefore, whenever ProtoSounds® senses that the Trainmaster system is being used, it automatically disables ProtoSounds® sound effects. The operator retains control over the engine, but no sound effects will play.

Transformer Model	Center Rail	Outside Rail	Min/Max. Voltage	Power Rating	Transformer Type
Lionel 1032	U	A	5-16v*	90-Watt	Standard
Lionel 1032M	U	A	5-16v*	90-Watt	Standard
Lionel 1033	U	A	5-16v*	90-Watt	Standard
Lionel 1043	U	A	5-16v*	90-Watt	Standard
Lionel 1043M	U	A	5-16v*	90-Watt	Standard
Lionel 1044	U	A	5-16v*	90-Watt	Standard
Lionel 1053	U	A	8-17v	60-Watt	Standard
Lionel 1063	U	A	8-17v	60-Watt	Standard
All-Trol	Left Terminal	Right Terminal	0-24v	300-Watt	Electronic
Cab-1/Powermaster	A	U	0-18v	135V.A.	Electronic
Dallee Hostler	Left Terminal	Right Terminal			
Lionel LW	A	U	8-18v	75-Watt	Standard
Lionel KW	A or B	U	6-20v	190-Watt	Standard
MRC Tech II	Left Terminal	2 <sup>nd</sup> From Left	0-15v*	40V.A.	Electronic
Lionel MW (not recommended)	Outside Track Terminal	Inside Track Terminal	5-16v*	50V.A.	Electronic
R.O.W.	Red Terminal	Black Terminal	0-24v	384-Watt	Standard
Lionel RS-1	Red Terminal	Black Terminal	0-18v	50V.A.	Electronic
Lionel RW	U	A	9-19v	110-Watt	Standard
Lionel SW	U	A	Unknown	130-Watt	Standard
Lionel TW	U	A	8-18v	175-Watt	Standard
Lionel ZW	A or D	U	8-20v	275-Watt	Standard
MTH Z500	Red	Black	5-18v	50-Watt	Electronic
MTH Z750	Red	Black	5-18v	75-Watt	Electronic
MTH Z4000	Red	Black	5-22v	390-Watt	Electronic

## O-27 OPERATION

While the 4-6-0 engine is more than capable of operating on O-27 curves and switches, you may find that certain light freight cars are prone to derailling when being pulled or pushed by the NYC 4-6-0 through O-27 switches. Should this occur, we suggest adding weight to the cars making them heavier and less likely to derail.

### **WARNING:**

When using electrical products, basic safety precautions should be followed including the following:

- Read this and all related manuals (transformer/power supply, locomotive, etc.) thoroughly before using this device.
- This device is not recommended for children under ten years of age without adult supervision.
- MTH recommends parents examine the toy transformer used to power this device periodically for conditions that may result in the risk of fire, electric shock, or injury to persons, such as damage to the primary or output cord, plug blades, housing or other parts (including proper functioning of the circuit breaker), and that, in an event such conditions exist, the transformer should not be used until properly repaired.







Notes: \_\_\_\_\_

Lined area for notes with horizontal ruling lines.

# SERVICE & WARRANTY INFORMATION

## HOW TO GET SERVICE UNDER THE TERMS OF THE LIMITED ONE YEAR WARRANTY

For warranty repair, do not return your product to the place of purchase. Instead, follow the instructions below to obtain warranty service as our dealer network is not prepared to service the product under the terms of this warranty.

1. First, write, call, email or FAX MTH Electric Trains, 7020 Columbia Gateway Drive, Columbia, MD 21046, 410-381-2580 (FAX No. 410-423-0009), or on the internet at [service@mth-railking.com](mailto:service@mth-railking.com) or our web site, [www.mthtrains.com](http://www.mthtrains.com), stating which product you have, when it was purchased and what seems to be the problem. You will be given a return authorization number to assure that your merchandise will be properly handled upon its receipt at MTH.

2. CAUTION: Make sure the product is packed in its original factory packaging, including its foam and plastic wrapping material so as to prevent damage to the merchandise. The shipment must be prepaid and we recommend that it be insured. *A cover letter, including your name, address, daytime phone number, a copy of your sales receipt, the Return Authorization number and a full description of the problem must be included to facilitate the repairs. Please include the description regardless of whether or not you discussed the problem with one of our service technicians when contacting MTH for your Return Authorization number.*

3. Please make sure you have followed the instructions carefully before returning any merchandise for service.

## LIMITED ONE YEAR WARRANTY

This item is warranted for one year from the date of purchase against defects in material or workmanship. We will repair or replace (at our option) the defective part without charge for parts or labor, if the item is returned to the address below within one year of the original date of purchase. This warranty does not cover items that have been abused or damaged by careless handling nor does it cover light bulbs or traction tires. Transportation costs incurred by the customer are not covered under this warranty.

This warranty gives you specific legal rights and you may have other rights which vary from state to state.

ProtoSounds® is a trademark of MTH Electric Trains. DCRU® is a registered copyright of QS Industries, Inc.

Lionel® is a registered trademark of Lionel L.L.C.. Railsounds® is a registered trademark of Lionel L.L.C.