



F-3 PASSENGER TRAIN SET OPERATING INSTRUCTIONS



Making the Most of Your Investment

Thank you for purchasing this RailKing Ready-to-Run F-3 Passenger Train Set. We at MTH Electric Trains take pride in manufacturing quality products like your set, and we hope that you will enjoy it for a long time. To ensure the maximum durability and pleasure from locomotive, rolling stock, track and transformer, please read all the way through the **Quick Start Basic Operating Instructions** you will find on pages 4. Remember that a little attention to routine maintenance yields a maximum of trouble-free performance.

RAIL
KING

Table Of Contents

QUICK START - BASIC OPERATION(4
Setting Up The RiteTrax® Track System	4
Preparing The Locomotive & Cars For Operation	6
Lubrication	6
Operating The Locomotive & Cars	7
Electronic Reverse Unit	7
Transformer Operation	8
Special Reverse Unit Options	9
TRAIN SET MAINTENANCE	11
Oil	11
Grease	12
Locomotive Lamp Replacement	12
Passenger Car Lamp Replacement	13
Locomotive Traction Tire Replacement	15
RITETRAX® TRACK LAYOUT PLANS	16
TRANSFORMER COMPATIBILITY CHART	19
EXPLODED PARTS VIEW DIAGRAM	20
SAFETY & WARNING PRECAUTIONS	22
SERVICE AND WARRANTY INFORMATION	23
HOW TO GET SERVICE	23
LIMITED ONE YEAR WARRANTY	23

Compatibility

Our designers have sized the engine to operate on any traditional 0-27 or larger O Gauge track system, including RiteTrax using any standard AC transformer including the Z-750 transformer packaged in your set. (See page 19 for a complete list of compatible transformers as well as wiring instructions.) All RailKing products are compatible with most other 3-rail locomotives, rolling stock, and accessories.

Equipment Options

Your ready-to-run set features a F-3 Passenger Train locomotive equipped with an operating headlight, electronic horn, and DCRU® electronic reverse unit. All are simple and fun to operate. In addition to the locomotive, your set should also include an oval of RiteTrax® track (8 curved and 4 straight sections), a RiteTrax® lighted lock-on and wire harness set (for connecting the track to the transformer) and a 75-watt Z-750 transformer and controller.

You'll find complete instructions for choosing and setting up options in the following pages. If you don't read through the entire manual before starting to operate your equipment, be sure to check the **Quick Start Basic Operating Instructions**, which will give you the basics of the operating system.

CAUTION - ELECTRICALLY OPERATED PRODUCT:

Not recommended for children under ten years of age without adult supervision. As with all electric products, precautions should be observed during handling and use to reduce the risk of electric shock.

Transformer Ratings:

Input: 120 VAC

60 HZ Only

Output: 21VAC, 3.75A, 78VA

Quick Start Operating Instructions

Track and Power

Although MTH Electric Trains manufactures its own track and transformers, you can run your locomotive on 0-27 or wider-radius O gauge track wired to draw power from any of the standard compatible AC transformers listed in the chart on page 19. Be sure your track is in good condition—clean and securely connected—to keep the locomotive running and to prevent derailments. If you intend to utilize the RiteTrax® track sections included in the set, see the directions below.

Setting Up the RiteTrax® Oval

Unlike other O Gauge track systems, each RiteTrax® track section features a realistic built-in roadbed base, solid nickel-silver track rails and realistic railroad ties all designed to give the owner an authentic looking track system. In addition, each RiteTrax® track section employs the use of quick-connect connectors instead of track pins or railjoiners to assemble the track sections to one another. The quick connectors and built-in base allow RiteTrax® track sections to be setup anywhere, including some carpeted surfaces without the need for track nails or the worry of carpet stains.

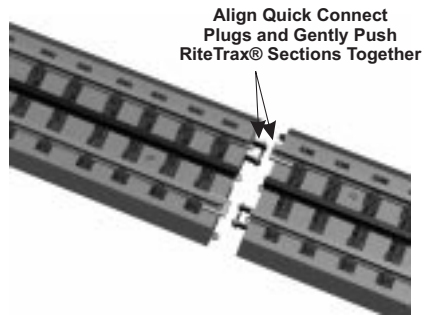

Figure 1: Preparing to snap RiteTrax® sections together by aligning Quick Connect Connectors together.



Figure 2: RiteTrax® sections in proper connected position.

You can set up literally hundreds of different track designs utilizing RiteTrax® components. We've included just a few later in this manual for your reference. Each layout specifies the space required and the components needed to

complete the track design. You can purchase additional track components from any authorized MTH reseller.

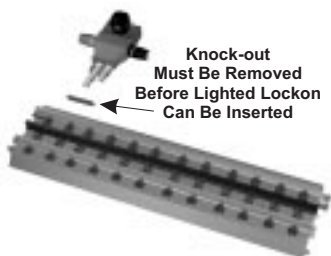

Figure 3: Top view position of lighted lockon preparing to enter RiteTrax® section.

transformer. Each RiteTrax® track section includes two “knock-out” tabs in the roadbed (on either end of the track) that must be removed

The lighted lockon included in your set snaps into any RiteTrax® track section roadbed and functions as the interface between the track and the

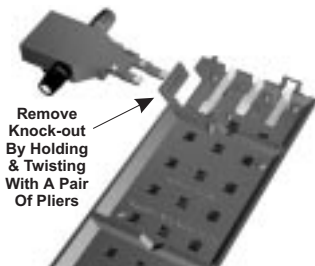

Figure 4: Underside view of RiteTrax® section with “knock-out” removed and lighted lockon in position for insertion.



Figure 5: Underside view of RiteTrax® track section with lighted lockon in fully seated position.

to reveal the opening for the lighted lockon. To remove this *knock-out* grab the *knock-out* with a pair of pliers and gently twist the *knock-out* until it snaps away from the roadbed base. Once the *knock-out* has been removed, snap the lighted lockon into the roadbed taking care to make sure that the lockon arms snap into the roadbed electrical receptors. To complete the connection between the RiteTrax® track section and the transformer, simply plug in the color-coded wire harness that was included in your set.



Figure 6: Top view of RiteTrax® section with lighted lockon in fully seated position.

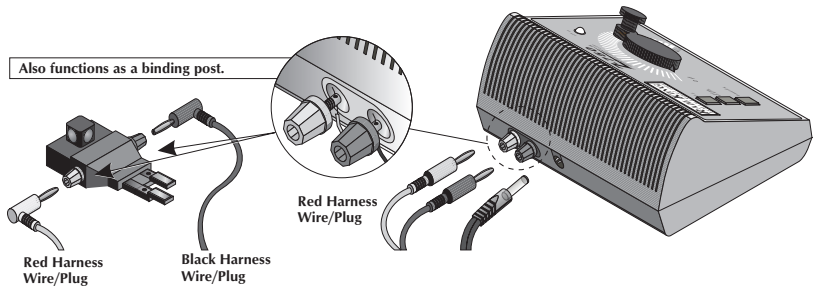

Figure 7: Wiring up the Z-750 transformer to the lighted lockon.

Preparing the Locomotive & Cars For Operation

Before you run your locomotive, you **must** oil the locomotive.

Lubrication

Before you run the locomotive, use a light household or hobby oil to lubricate the gears and pick up rollers. Apply a small drop of oil (a pinpoint oiler will help place the right amount of oil where you need it) to each of the points indicated by in the diagram in figures 8. You may also want to use either a locomotive repair cradle or an old towel folded over to provide a protective bed for the locomotive shell while you're working on it.

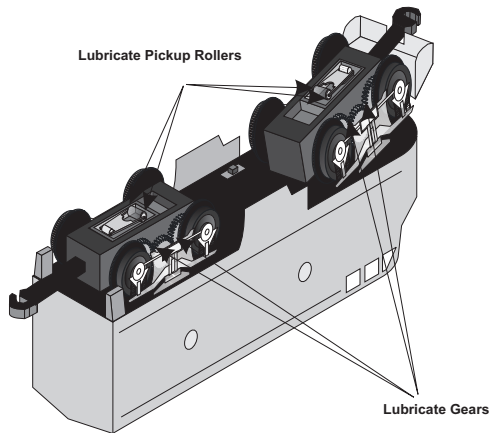

Figure 8: Lubrication points of RailKing F-3 Passenger locomotive.

Because the locomotives's internal gearing has been greased at the factory, you shouldn't need to add more grease until you have run the locomotive for 50 hours or owned it for a year, whichever comes first. See the section on lubrication, pages(s) 11-12, for detail.

Operating The Engine and Cars

Once the track has been assembled and the transformer wired to the track lock-on, you are almost ready to begin running your new train set. Place the engine and cars on the track and couple each up to one another. If the coupler is already closed, pressing down on the coupler armature will open the coupler knuckle to allow the couplers to interlock with one another. Before turning on the transformer, it is important to understand the features of your new train set.

**Pushing Down
On The Coupler
Armature Opens
The Coupler
Knuckle**

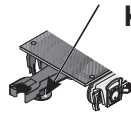
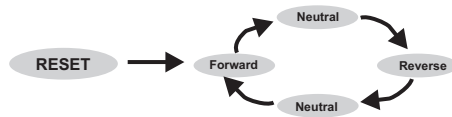

Figure 9: Pushing down on the coupler armature to open up the coupler knuckle.

Electronic Reverse Unit

The locomotive is controlled by a DCRU® electronic reverse unit. The reverse unit operates in the same manner that all reverse units function by using forward, neutral and reverse states that are entered each time the throttle is turned on and off or by using the transformer direction switch (if so equipped).



The reverse unit is designed to ignore dirty track, dead spots on switches or minor short circuits without disrupting the engine operation, even at slow, prototypical speeds. Once the engine is placed on the track, the transformer throttle can be advanced. You will see that only the engine's lights come on but that the engine does not run. This is known as the RESET state and is required when used with after-market MTH ProtoSound® sound systems. The DCRU® will not power the motor until the

throttle is turned OFF and then ON again. At this point, the engine will now function just like any other electronic or mechanical E-unit.

In addition to the DCRU® electronic reverse unit, your new train set locomotive features an electronic horn that can be activated by pressing the white Horn/Whistle button on your Z-750 transformer. Any compatible transformer whistle or horn button will also activate the horn in your new locomotive. Simply pressing the Horn/Whistle button whenever the throttle is above the OFF setting should activate the horn. If the horn doesn't blow, increase the throttle setting and press the button again. The horn will blow as long as the button is depressed.

Now, **if you've lubricated the locomotive friction points as indicated earlier**, you're almost ready to start running your train set.

Transformer Operation

The Z-750 provides the model railroad enthusiast with an easy to use, safe power source for AC-powered trains and accessories. Set up is quick and easy by following the setup diagram below.

Functions:

Bell: Press to activate a digital sound system bell (*not found on Amtrak F-3 Passenger Set model number 30-4018-0*), press again to deactivate.

Horn/Whistle: Press to activate.

Direction: Press to stop motion of train and press again to change direction

Figure 10: Z-750 Controls

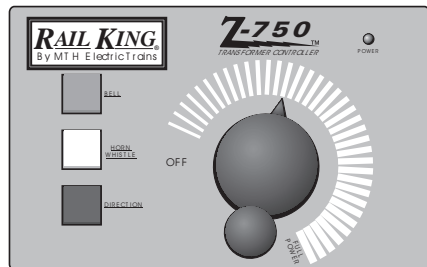

Starting to Roll

Advanced the transformer throttle. The locomotive's light will come on but the engine will not move until you turn the throttle back OFF and then ON again. The engine should now proceed in the forward direction. At this point, advancing the throttle further will allow the engine to pick up speed, reducing the throttle will slow the engine down. Turning the throttle OFF and then back ON will park the engine into neutral. Cycling the throttle OFF and then back ON again one more time will allow the locomotive to enter reverse.

An alternative method to using the throttle to enter the next reverse unit phase is to press the direction button. When depressed, the transformer interrupts all power to the track as long as the button is depressed. Releasing the button reapplies power to the track at whatever voltage level the transformer throttle is set at.

Press the horn button, the horn should sound.

Note: Pressing the bell button will have no affect on your engine because your locomotive is not equipped with a bell. Only locomotives equipped with full digital sound systems (which feature engine sounds, horns, bells, air-release sound effects, squeaking brakes and many other locomotive related sound effects) can utilize the bell button.

Special Reverse Unit Options

Locking Out The Reverse Unit Into One Full-Time Direction

Your DCRU® electronic reverse unit locomotive may be locked out into one of three positions; forward, neutral or reverse. Locking the engine into one of these three positions prevents the locomotive from cycling through the reverse unit phases and is useful for operators employing block signal operations on their layout. Once locked into a position, turning the

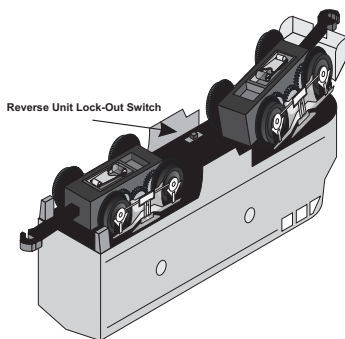

Figure 11: DCRU® Electronic Reverse Unit Lock-out Switch location.

throttle off and then on again will not allow the engine to enter the next reverse unit phase and instead keeps the engine in the current locked out phase.

To lock out the engine into one of the three positions, simply enter that position using the transformer throttle or direction button. Once in the desired direction, remove the locomotive from the track and slide the ON/OFF switch located on the bottom of the chassis (See Figure 11) to the OFF position. This locks the engine into the desired direction. Sliding the switch back to the ON position resets the DCRU® reverse unit into its normal reverse unit cycling phases.

Note: Once the DCRU® reverse unit is locked out and an hour or more of non-use has passed, the reverse unit may cycle into any of the three directional states. Should this occur, the ON/OFF switch should be reset to the ON position to regain normal operation. If the operator desires to lock the engine out in another direction state, repeat the above steps to do so.

Using the Z-750 With Self-Recharging, Battery Equipped After-Market Sound Systems

When using the Z-750 transformer with after-market digital sound systems employing a self-recharging battery backup system, operators should be aware MTH does not recommend leaving the engine in neutral with the power on and the throttle above the setting shown in Figure 10 for an extended period of time. If you are recharging the battery found in these after-market sound systems with a Z-750 transformer while in the neutral position, MTH recommends the throttle be positioned as shown in Figure 10 for optimum charging power.

Train Set Maintenance Instructions

Proper locomotive performance requires regular attention to lubrication. The following guidelines should be followed to ensure that your set's locomotive last for many years.

Oil

Before operating the locomotive, apply a small drop of oil to lubricate the gears and pick up rollers. Use light household oil and apply sparingly only to the points indicated by Figure 8 on page 6. Wipe away any excess, especially if oil spills onto the finish of the locomotive.

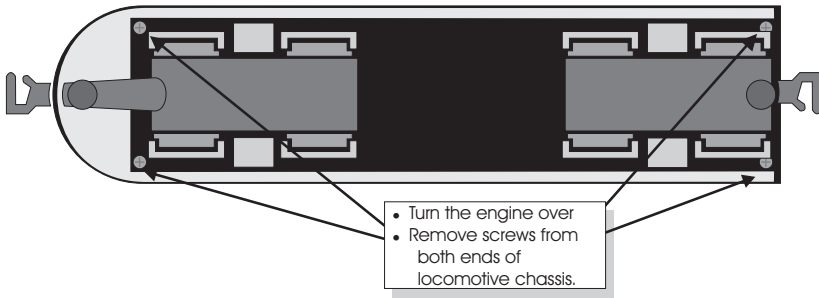

Figure 12: Removing the F-3 Passenger locomotive shell from the chassis.

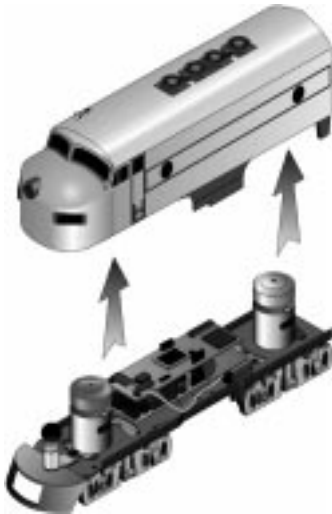

Figure 13: Lifting the body away from the chassis.

To prevent accidental scratches or other damage to the locomotive shell while you are working, you may want to place the locomotive in a repair cradle or an old towel or other cloth folded to provide a firm but soft resting place.

Check the locomotive oiling points periodically to be sure they are moving freely and quietly. If they are not, apply small

amount of oil again. Also check locomotive wheels for dirt build up that can cause performance problems. Such dirt build up can interfere with electrical contacts, reduce traction (especially on elevated track sections), and cause neprene traction tires to wear out prematurely.

Grease

Your locomotive's internal gearing has been greased at the factory and should not need additional grease until you have run the locomotive for over 50 hours or owned it for a year, whichever comes first.

Add grease by inserting it into the gear box inside the locomotive chassis. To reach the gear box, remove the cab from the chassis by unscrewing the four chassis screws as indicated in Figure 13 on page 11. Once you have removed the cab, remove the truck mounting

screws holding the truck to the motor. After removing this motor mount screw, lift the motor away from the truck and use a grease tube dispenser to coat the bronze drive gear inside the truck and the motor worm gear on the motor. Reinsert the motor down into the truck and reinstall the motor mount screws. Then fit the cab back in place and reinsert the four chassis screws.

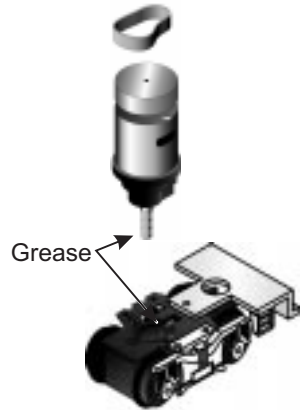

Figure 14: Grease Lubrication Points

Locomotive Lamp Replacement

Your locomotive and Superliner cars may occasionally burn out their headlights and/or interior lights. Should this occur, you will need to remove the body from the chassis in order to replace the burned out bulb.



- Rotate bulb 1/4 turn counter-clockwise to release from housing

Figure 15: Removing the locomotive headlight bulb.

To remove the F-3 Passenger cab from its chassis, follow the body removal instructions on the previous pages. Once the body has been removed, push the headlight bulb downward and rotate it counter-clockwise as seen in Figure 15 to remove the burned out bulb.

Passenger Car Lamp Replacement

To remove a passenger car body from its chassis, turn the car over and locate and remove the two mounting screws (as seen in Figure 16) attaching the roof to the body and chassis. Once the screws are removed, gently lift the car roof up and away from the body and chassis (see Figure 17).

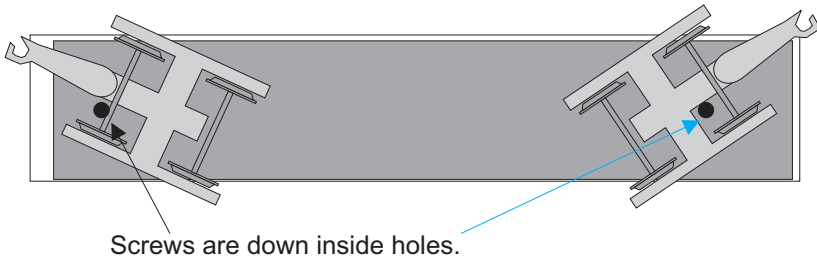
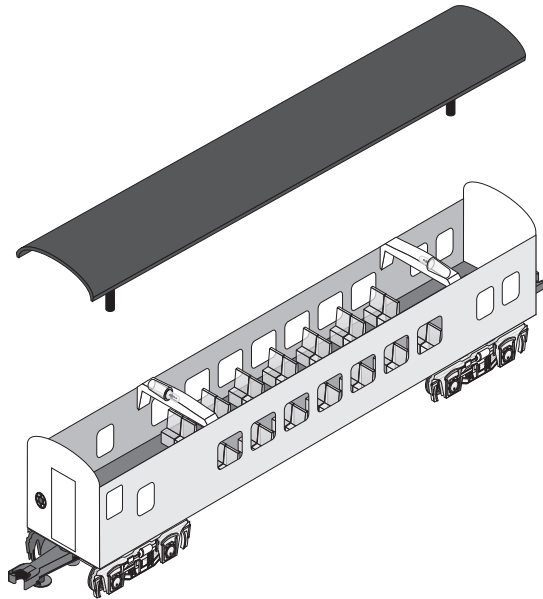

Figure 16: Removing the passenger car body from its chassis.

Figure 17: Lifting the Passenger Car roof away from its body.



After removing the roof from the body and chassis, locate the car interior lamp housings mounted on the inside of the car body. Once

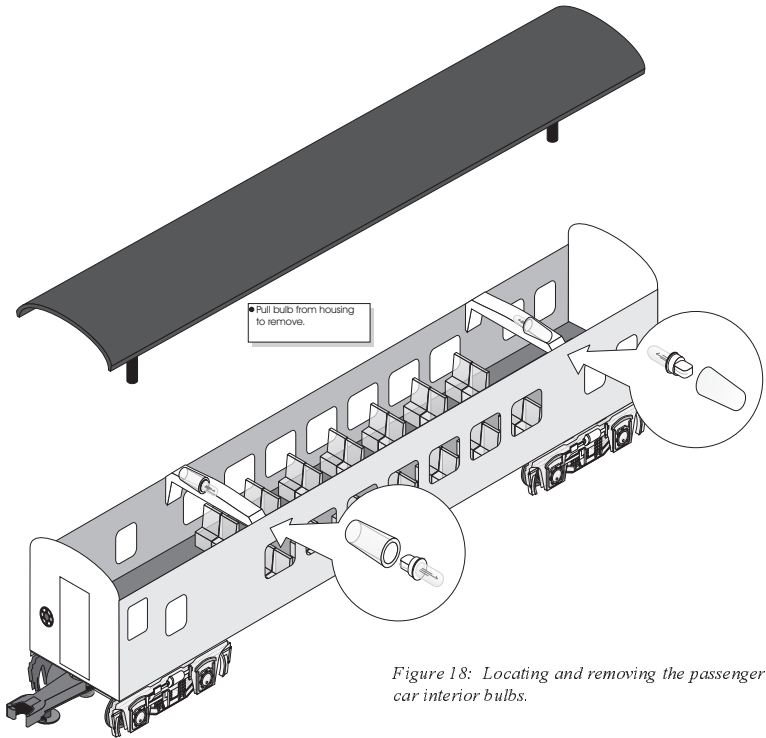

Figure 18: Locating and removing the passenger car interior bulbs.

the lamp housing has been located, remove the burned out interior bulb by gently pulling the bulb away from its housing (see Figure 18). To replace the bulb, simply plug the replacement bulb into the empty lamp housing (see Figure 19) and reassemble the lamp housing to the car roof.

- To replace bulb, simply fit a new bulb in the area left by the old one.
- Reassemble lighting assembly and car body.

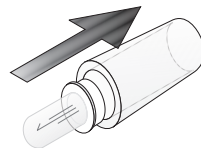

Figure 19: Inserting the replacement passenger car interior bulb.

Locomotive Traction Tire Replacement Instructions

Your locomotive is equipped with four neoprene rubber traction tires (two on each power truck). While these tires are extremely durable and long-lasting there may arise a time where they will need to be replaced. Should this occur, you will need to remove the trucks from the chassis in order to slip the new tire over the grooved drive wheel. Follow the lubrication instructions on the previous pages for removing the trucks from the chassis. Once the trucks have been removed, you will need to remove the trucksides in order to gain free access to the wheels and the rubber traction tire grooves. See Figure 20 to remove the trucksides.

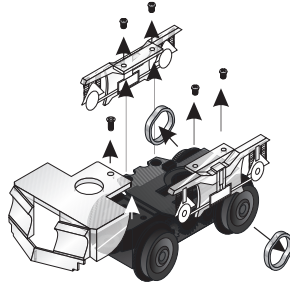

Figure 20: Removing locomotive trucksides for traction tire replacement.

Before the new tire can be installed, you must make sure the old tire has been completely removed from the groove in the drive wheel. Use a razor blade or small flatblade screwdriver pry away any remains left from the old tire that may still be in the drive wheel groove. Once the old tire has been completely removed, slip the new tire onto the wheel. You may find it useful to use two small flatblade screwdrivers to assist you in stretching the tire over the wheel. Be careful to avoid twisting the tire when stretching it over the wheel. If a twist occurs, the tire will have to be removed and reinstalled or a noticeable wobble in your engine will occur when operating the locomotive. In addition, it is important to make sure that the tire is fully seated inside the groove. Any portion of the tire extending out of the groove can cause the engine to wobble. A razor blade can be used to trim away any excess tire that doesn't seat itself inside the groove properly.

Replacement tires are available directly from MTH Electric Trains.

RiteTrax® Layout Plans

The following track plans are just some of the many different track plans you can utilize when designing your model railroad. Each track plan contains a table indicating which track components and how many you will need to purchase. Some track plans may require additional transformer power to accommodate the current draws of the various accessories featured in the layout, including switches and lights.

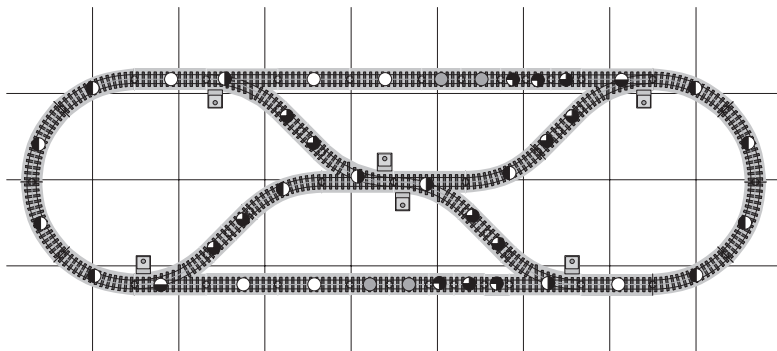

Track List:

	Item #
(6) ○ 10" Straight	(40-1001)
(10) ● O-31 Curved	(40-1002)
(4) ● O-31 Right Hand Switch	(40-1004)
(2) ● O-31 Left Hand Switch	(40-1005)
(4) ● 5.5" Straight	(40-1012)
(10) ● 4.25" Straight	(40-1017)
(4) ● 3.5" Straight	(40-1018)

Approximate Layout Size:

102' x 32" (2.6m x 0.8m)

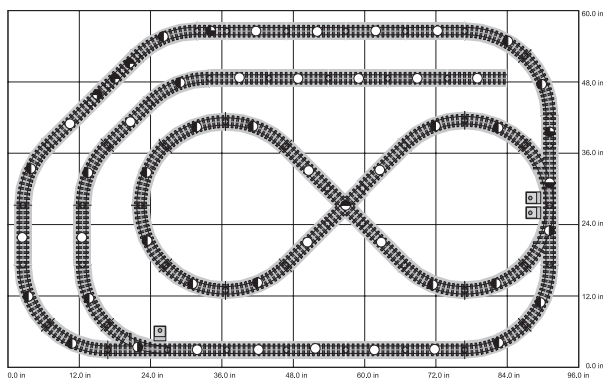

Track List:

	Item #
(22) ○ 10" Straight	(40-1001)
(21) ● O-31 Curved	(40-1002)
(2) ● O-31 Right Hand Switch	(40-1004)
(1) ● O-31 Left Hand Switch	(40-1005)
(1) ● 90 Degree Crossing	(40-1006)
(2) ● 5.0" Straight	(40-1016)
(1) ● 4.25" Straight	(40-1017)
(2) ● 3.5" Straight	(40-1018)

Approximate Layout Size:

96' x 60" (2.4m x 1.5m)

inXide.mt
size: 6.00 x 5.00
track sections: 52

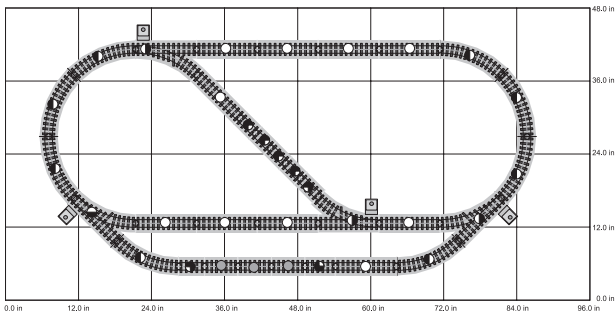

Intrevo31.rtt
size: 8.00 x 4.00
track sections: 32

Track List:	Item #
(10) ○ 10" Straight	(40-1001)
(8) ● O-31 Curved	(40-1002)
(3) ● O-31 Right Hand Switch	(40-1004)
(1) ● O-31 Left Hand Switch	(40-1005)
(3) ● 5.5" Straight	(40-1012)
(1) ● 5.0" Straight	(40-1016)
(2) ● 4.25" Straight	(40-1017)
(4) ● 3.5" Straight	(40-1018)

Approximate Layout Size:
54" x 42" (2.1m x 1.1m)

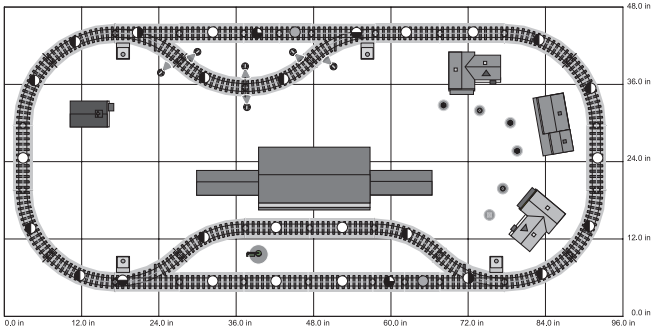

Introdings5.rtt
size: 8.00 x 4.00
track sections: 30

Track List:	Item #
(10) ○ 10" Straight	(40-1001)
(12) ● O-31 Curved	(40-1002)
(2) ● O-31 Right Hand Switch	(40-1004)
(2) ● O-31 Left Hand Switch	(40-1005)
(2) ● 5.5" Straight	(40-1012)
(2) ● 5.0" Straight	(40-1016)

Approximate Layout Size:
92" x 42" (2.3m x 1.1m)

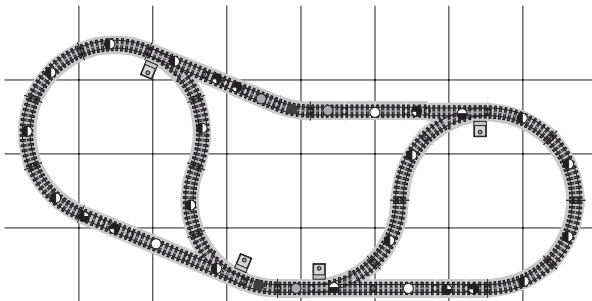

Track List:	Item #
(3) ○ 10" Straight	(40-1001)
(12) ● O-31 Curved	(40-1002)
(2) ● O-31 Right Hand Switch	(40-1004)
(2) ● O-31 Left Hand Switch	(40-1005)
(3) ● 5.5" Straight	(40-1012)
(5) ● 5.0" Straight	(40-1016)
(5) ● 3.5" Straight	(40-1018)
(2) ● O-31 Half-Curved	(40-1022)

Approximate Layout Size:
95" x 48" (2.4m x 1.2m)

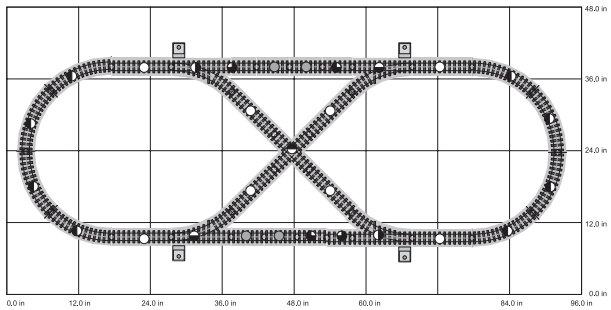

Track List:	Item #
(8) 10° Straight	(40-1001)
(8) O-31 Curved	(40-1002)
(2) O-31 Right Hand Switch	(40-1004)
(2) O-31 Left Hand Switch	(40-1005)
(1) 90 Degree Crossing	(40-1006)
(4) 5.5° Straight	(40-1012)
(2) 5.0° Straight	(40-1016)
(2) 4.25° Straight	(40-1017)

Approximate Layout Size:
92" x 36" (2.3m x 0.9m)

Ovale.krt
size: 8.00 x 4.00
track sections: 37

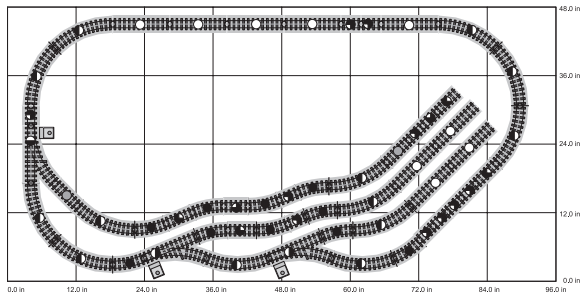

Track List:	Item #
(9) 10° Straight	(40-1001)
(13) O-31 Curved	(40-1002)
(2) O-31 Right Hand Switch	(40-1004)
(1) O-31 Left Hand Switch	(40-1005)
(2) 5.5° Straight	(40-1012)
(4) 5.0° Straight	(40-1016)
(2) 4.25° Straight	(40-1017)
(10) O-31 Half Curved	(40-1022)
(10) 3.5° Straight	(40-1018)

Approximate Layout Size:
90" x 46" (2.3m x 1.2m)

Source1.krt
size: 6.00 x 4.00
track sections: 53

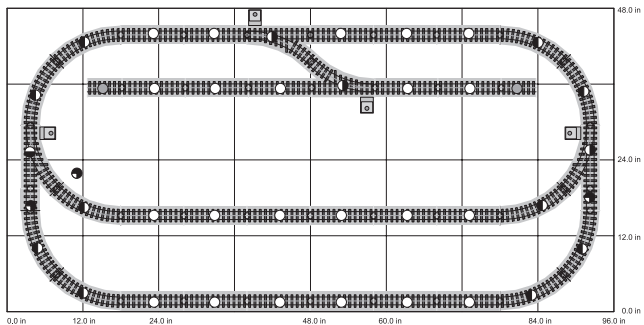

Track List:	Item #
(22) 10° Straight	(40-1001)
(10) O-31 Curved	(40-1002)
(3) O-31 Right Hand Switch	(40-1004)
(1) O-31 Left Hand Switch	(40-1005)
(2) 5.5° Straight	(40-1012)
(2) 3.5° Straight	(40-1018)

Approximate Layout Size:
96" x 48" (2.4m x 1.2m)

Siding.krt
size: 8.00 x 4.00
track sections: 40

TRANSFORMER COMPATIBILITY AND WIRING CHART

ProtoSounds® is designed to work with any standard AC transformer that uses a "Pure Sine-Wave" format. The chart below lists the many Lionel® compatible transformers, such as the Lionel KW or ZW models. In addition, the chart details how the terminals on these compatible transformers should be attached to your layout. The Trainmaster system from Lionel® will not function correctly with ProtoSounds® without disrupting the sound effects. Therefore, whenever ProtoSounds® senses that the Trainmaster system is being used, it automatically disables ProtoSounds® sound effects. The operator retains control over the engine, but no sound effects will play.

Transformer Model	Center Rail	Outside Rail	Min/Max. Voltage	Power Rating	Transformer Type
Lionel 1032	U	A	5-16v*	90-Watt	Standard**
Lionel 1032M	U	A	5-16v*	90-Watt	Standard**
Lionel 1033	U	A	5-16v*	90-Watt	Standard**
Lionel 1043	U	A	5-16v*	90-Watt	Standard**
Lionel 1043M	U	A	5-16v*	90-Watt	Standard**
Lionel 1044	U	A	5-16v*	90-Watt	Standard**
Lionel 1053	U	A	8-17v	60-Watt	Standard**
Lionel 1063	U	A	8-17v	60-Watt	Standard**
All-Trol	Left Terminal	Right Terminal	0-24v	300-Watt	Electronic^A
Cab-1/Powermaster	A	U	0-18v	135V. A.	Electronic^A
Dallee Hostler	Left Terminal	Right Terminal			
Lionel LW	A	U	8-18v	75-Watt	Standard**
Lionel KW	A or B	U	6-20v	190-Watt	Standard**
MRC Tech II	Left Terminal	2 nd From Left	0-15v*	40V. A.	Electronic
Lionel MW	Outside Track Terminal	Inside Track Terminal	5-16v*	50V. A.	Electronic
R. O. W.	Red Terminal	Black Terminal	0-24v	384-Watt	Standard**
Lionel RS-1	Red Terminal	Black Terminal	0-18v	50V. A.	Electronic
Lionel RW	U	A	9-19v	110-Watt	Standard**
Lionel SW	U	A	Unknown	130-Watt	Standard**
Lionel TW	U	A	8-18v	175-Watt	Standard**
Lionel ZW	A, B, C or D	U	8-20v	275-Watt	Standard**
Lionel Trainmaster	Red Terminal	Black Terminal	0-18v	135-Watt	Electronic
MTH Z-500	Red Terminal	Black Terminal	0-18v	50-Watt	Electronic
MTH Z-750	Red Terminal	Black Terminal	0-21v	75-Watt	Electronic
MTH Z-4000	Red Terminal	Black Terminal	0-22v	400-Watt	Electronic

Exploded Parts View

The chart and diagram on the next several pages should be referenced when requesting replacement parts for your RailKing locomotive and cars. Parts can be ordered directly from MTH Electric Trains, 7020 Columbia Gateway Drive, Columbia, MD 21046-1532

F-3 Diesel Engine A-Unit (Powered A Unit)

Powered Unit Parts

Name	Part #
1.) Shell (Santa Fe)	FC-2200021
1.) Shell (PRR)	FC-2200022
2.) Portal Lens	FA-2260001
3.) Windows	FA-2230008
4.) Headlight Lens	FA-2230009
5.) Battery Leads (14.5mm long wires)	BC-4000001
6.) Battery	BG-4000001
7.) Proto Sound Board (top)	AE-4500001
8.) Proto Sound Chip	N/A
9.) Proto Sound Board (Bottom)	AD-4500001
10.) Proto Sound Bracket (Front)	IH-4500018
11.) Screw (M2.5 x 3.0mm)[roundhead]	IA-0000002
12.) Bulb (18v, small globe, bayonet base)	CG-0000002
13.) Socket	CH-0000005
14.) Screw (4-40 x 16.0mm)[roundhead]	IA-0000047
15.) Screw (4-40 x 6.0mm)[roundhead]	IA-0000003
16.) Screw (M2.5 x 5.0mm)[roundhead]	IA-0000044
17.) Insulator	ID-0000026
18.) Insulator	ID-0000033
19.) Speaker (Unison. U4508B5R, 8Ω, 9w)	BF-4500013
20.) Screw (4-40 x 6.0mm)[roundhead]	IA-0000003
21.) Bracket (Proto sound board/volume pot)	IH-4500019
22.) Rubber band	BI-4500004
23.) Motor (RS-365SH)	BE-0000019
24.) Motor Mount	BI-0000005
25.) Volume Pot	BI-4500009
26.) Screw (M2.5 x 3.0mm)[roundhead]	IA-0000022
27.) Bracket (speaker)	IH-0000002
28.) Switch (large)	BB-0000010
29.) Screw (M2 x 4.0mm)[panhead]	IA-0000007
30.) Wire harness	BC-0000004
31.) Screw (M3 x 16.0mm)[washerhead][self drilling]	IA-0000025
32.) T-bar (4.0 x 20.0mm)	IG-0000001
33.) Coupler (Non-operating)[34.5mm long]	DD-4000005
34.) Spring (5.5 x 14.0mm)	IE-0000017
35.) E-clip (3.0 x 8.0 x .6mm)	IF-0000002
36.) Screw (M3 x 6.0mm)[roundhead]	IA-0000016
37.) Wire strap (metal)	IH-0000012
38.) Nut (2.5 x 5.0 x 10.0mm)	IC-0000005

Name	Part #
39.) Pick-up (8.0mm roller)[29.0mm long]	BD-0000038
40.) Screw (M3 x 6.0mm)[chrome,roundhead]	IA-0000022
41.) Insulator (Pick up, bottom, rect.)(18.0 x 30.0mm)	BD-0000039
42.) Screw (M3 x 12.0mm)[roundhead w/lock washer]	IA-0000020
43.) Truck (2axle)	DA-2050004
44.) Insulator (Pick up, top, square)	BD-0000035
45.) Screw (M3 x 6.0mm)[chrome, roundhead]	IA-0000015
46.) Screw (4-40 x 6.0mm)[roundhead]	IA-0000003
47.) Screw (M3 x 6.0mm)[roundhead]	IA-0000016
48.) Screw (M2.5 x 6.0mm)[roundhead w/lock washer][yellow zinc]	IA-0000001
49.) Screw (M3 x 14.0mm)[Flat head, self drilling]	IA-0000009
50.) Truckside (silver)	DB-2050001
50.) Truckside (black)	DB-2050002
51.) Screw (M3 x 6.0mm)[roundhead]	IA-0000016
52.) Pilot (silver)	DG-2230001
52.) Pilot (tuscan red)	DG-2230002
53.) E-clip (3.0 x 8.0 x .6mm)	IF-0000002
54.) Washer (4.5 x 10.0 x 1.0mm)	ID-0000026
55.) Spring (5.5 x 14.0)	IE-0000017
56.) Proto coupler (44.0mm long)	DD-0000004
57.) T-bar (4.0 x 20.0mm)	IG-0000001
58.) Chassis	DH-2200005
59.) Horn	FC-2200010
60.) Number Board (#9505)	FG-2200003
60.) Number Board (#16)	FG-2200004

Horn Only Parts

N.S. = Not Shown In Exploded View

7.) Board (Horn)	AF-4500004
9.) Board (DCRU)	AC-0000001
N.S. Screw (DCRU mounting screw)[4-40 x 20mm][roundhead]	IA-0000048
N.S. Heat sink (3.0 x 20.0 x 5.0mm)	AI-4500007
N.S. Bracket (DCRU)[35.0 x 22.0mm]	IH-0000035
N.S. Screw (DCRU bracket mounting screws)[2.5 x 3.0mm][roundhead]	IA-0000022
28.) Switch (small)	BB-0000009
29.) Screw (M2 x 4.0mm)	IA-0000007
67.) Coupler (Mechanical)[44.0mm long]	DD-0000003
68.) Coupler Armature plate (37.6mm long)	DD-0000002

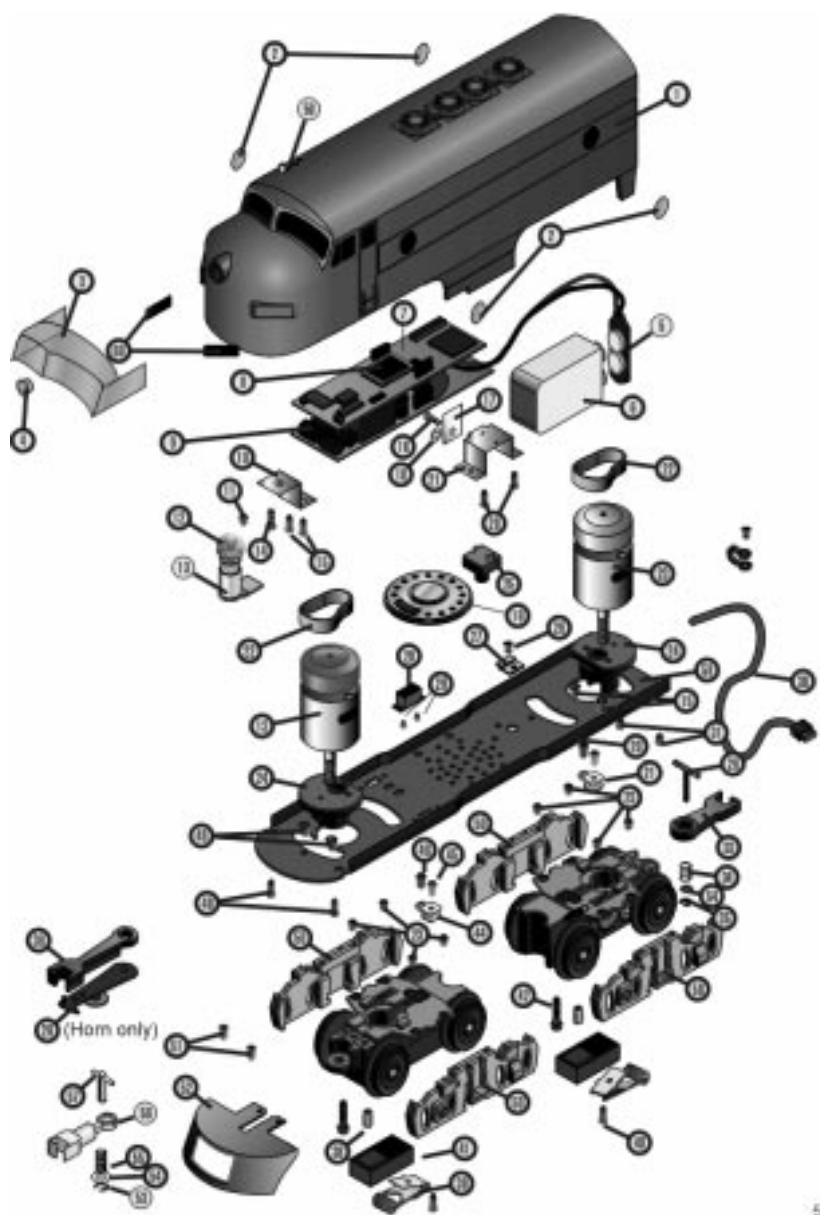

WARNING:

When using electrical products, basic safety precautions should be followed including the following:

Read this manual thoroughly before using this device.

This device is not recommended for children under ten years of age without adult supervision.

MTH recommends parents examine the toy transformer periodically for conditions that may result in the risk of fire, electric shock, or injury to persons, such as damage to the primary or output cord, plug blades, housing or other parts, and that, in an event such conditions exist, the transformer should not be used until properly repaired.

This Z-750 Hobby Transformer Power Unit is intended to be used indoors. Do not use if water is present. Serious or fatal injury may result.

Do not use this Z-750 Hobby Transformer Power Unit for other than its intended purpose. This unit was designed to operate with Z-750 Control Unit.

This Z-750 Hobby Transformer Power Unit was designed to operate on 120 volt, 60 Hertz power. Do not connect to any other source of power.

Do not operate the Z-750 Hobby Transformer Power Unit with damaged cord, plug or case.

To avoid the risk of electrical shock, do not disassemble the unit. There are no user serviceable parts inside. If damaged call MTH service for instructions.

CAUTION: Do not operate your layout unattended. Obstructed accessories or stalled trains may overheat resulting in damage to your layout.

If the circuit breaker trips, unplug the power cord from power source (electrical wall outlet), check your layout for any short circuits, reset the circuit breaker, plug the power cord into the power source (electrical wall outlet), and resume operation. Unplug the Z-750 Hobby Transformer Power Unit from power source (electrical wall outlet) when not in use.

SERVICE AND WARRANTY INFORMATION

HOW TO GET SERVICE UNDER THE TERMS OF THE LIMITED ONE YEAR WARRANTY

For warranty repair, do not return your product to the place of purchase. Instead, follow the instructions below to obtain warranty service as our dealer network is not prepared to service the product under the terms of this warranty.

1. First, write, call or FAX MTH Electric Trains, 7020 Columbia Gateway Drive, Columbia, MD 21046, 410-381-2580 (FAX No. 410-381-6122), stating when it was purchased and what seems to be the problem. You will be given a return authorization number to assure that your merchandise will be properly handled upon its receipt.

2. CAUTION: Make sure the product is packed in its original factory packaging including its foam and plastic wrapping material so as to prevent damage to the merchandise. The shipment must be prepaid and we recommend that it be insured. *A cover letter, including your name, address, daytime phone number, a copy of your sales receipt, a Return Authorization number and a full description of the problem, must be included to facilitate the repairs. Please include the description regardless of whether you discussed the problem with one of our service technicians when contacting MTH for your Return Authorization number.*

3. Please make sure you have followed the instructions carefully before returning any merchandise for service.

LIMITED ONE YEAR WARRANTY

This item is warranted for one year from the date of purchase against defects in material or workmanship. We will repair or replace (at our option) the defective part without charge for parts or labor, if the item is returned to the address below within one year of the original date of purchase. This warranty does not cover items that have been abused or damaged by careless handling, traction tires, pickup rollers or lamps. Transportation costs incurred by the customer are not covered under this warranty.

This warranty gives you specific legal rights and you may have other rights which vary from state to state.

Proto-Sound® is a trademark of MTH Electric Trains. DCRU® is a registered copyright of QS Industries, Inc.