



DIESEL “Work Train” TRAIN SET & PROTO-SOUND® OPERATING INSTRUCTIONS



Making the Most of Your Investment

Thank you for purchasing this RailKing Ready-to-Run Diesel “Work Train” Train Set. We at MTH Electric Trains take pride in manufacturing quality products like your set, and we hope that you will enjoy it for a long time. To ensure the maximum durability and pleasure from locomotive, rolling stock, track and transformer, please read all the way through the **Quick Start Basic Operating Instructions** you will find on pages 4. Remember that a little attention to routine maintenance yields a maximum of trouble-free performance.

RAIL
KING

Table Of Contents

QUICK START - BASIC OPERATION	4
Reverse Unit Operation	7
Horn Operation	9
Bell Operation	9
ProtoCoupler® Operation	9
Diesel Cab Chatter Sounds	11
Squeaking Brake Sounds	11
Tips On Using The Squeaking Brake Sounds	12
Freight Yard Sounds (FYS)	13
Activating and Triggering Freight Yard Sounds	15
Tips On Using FYS Features	18
REVERSE UNIT LOCK-OUT OPERATION	19
Locking The Engine Into Forward or Reverse	19
Unlocking The Engine	19
Locking The Engine Into Neutral	20
OTHER PROTO-SOUND® OPERATING FEATURES	20
Self-Recharging Battery Backup System	20
Replacing The ProtoSound® Battery	21
ProtoSound® Volume Adjustment	22
OPERATING AND PROGRAMMING PROTO-SOUNDS®	22
Using RESET To Program Proto-Sound®	24
Remotely Setting The Engine Volume	24
Bell Button Programming	25
Squeaking Brake Operation Programming	26
Horn In Neutral Operation Programming	27
ProtoCoupler® Operation Programming	27
Cab Chatter Operation Programming	28
FYS Operation Programming	28
Activating Remote Lockout Control	29
ResettingAll Proto-Sound® Options To Factory Default	30
TRAIN SET MAINTENANCE INSTRUCTIONS	31
Oiling Directions	31
Greasing Directions	32
Locomotive Lamp Replacement	32
Caboose Car Lamp Replacement	33
Locomotive Traction Tire Replacement	35
RITETRAX® TRACK LAYOUT PLANS	36
TRANSFORMER AND PROTO-SOUND® REFERENCE	39
Transformer Compatibility and Wiring Chart	39
Trouble-Shooting Proto-Sound® Problems	40
Proto-Sound® RESET Feature Chart	43
LOCOMOTIVE EXPLODED PARTS DIAGRAM	44
WARNING AND SAFETY PRECAUTIONS	46
SERVICE AND WARRANTY INFORMATION	47
How To Get Warranty/Repair Service	47
Limited One-Year Warranty	47

Compatibility

Our designers have sized the engine to operate on any traditional 0-27 or larger O Gauge track system, including RiteTrax using any standard AC transformer including the Z-750 transformer packaged in your set. (See page 39 for a complete list of compatible transformers as well as wiring instructions.) All RailKing products are compatible with most other 3-rail locomotives, rolling stock, and accessories.

Equipment Options

Your ready-to-run set features a four-car Superliner Passenger Set and a Diesel “Work Train” locomotive equipped with an operating headlight, Proto-Sound® Digital Sound and Train Control System and remote controlled ProtoCoupler® uncoupling system. All are simple and fun to operate. In addition to the locomotive, your set should also include an oval of RiteTrax® track (8 curved and 4 straight sections), a RiteTrax® lighted lock-on and wire harness set (for connecting the track to the transformer) and a 75-watt Z-750 transformer and controller.

You’ll find complete instructions for choosing and setting up options in the following pages. If you don’t read through the entire manual before starting to operate your equipment, be sure to check the **Quick Start Basic Operating Instructions**, which will give you the basics of the operating system.

CAUTION – ELECTRICALLY OPERATED PRODUCT:

Not recommended for children under ten years of age without adult supervision. As with all electric products, precautions should be observed during handling and use to reduce the risk of electric shock.

Transformer Ratings:

Input: 120 VAC

60 HZ Only

Output: 21VAC, 3.75A 78VA

Quick Start Operating Instructions

Track and Power

Although MTH Electric Trains manufactures its own track and transformers, you can run your locomotive on 0-27 or wider-radius O gauge track wired to draw power from any of the standard compatible AC transformers listed in the chart on page 39. Be sure your track is in good condition—clean and securely connected—to keep the locomotive running and to prevent derailments. If you intend to utilize the RiteTrax® track sections included in the set, see the directions below.

Setting Up the RiteTrax® Oval

Unlike other O Gauge track systems, each RiteTrax® track section features a realistic built-in roadbed base, solid nickel-silver track rails and realistic railroad ties all designed to give the owner an authentic looking track system. In addition, each RiteTrax® track section employs the use of quick-connect connectors instead of track pins or railjoiners to assemble the track sections to one another. The quick connectors and built-in base allow RiteTrax® track sections to be setup anywhere, including some carpeted surfaces without the need for track nails or the worry of carpet stains.

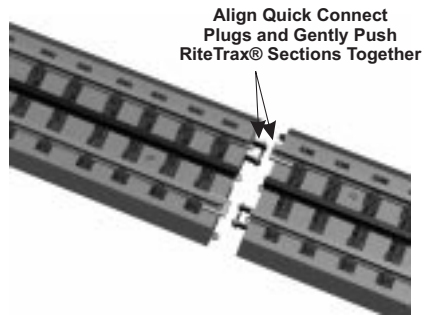

Figure 1: Preparing to snap RiteTrax® sections together by aligning Quick Connect Connectors together.

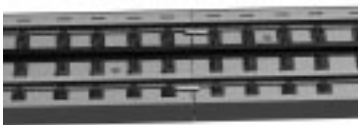

Figure 2: RiteTrax® sections in proper connected position.

You can set up literally hundreds of different track designs utilizing RiteTrax® components. We've included just a few later in this manual for your reference. Each layout specifies the space required and the components needed to

complete the track design. You can purchase additional track components from any authorized MTH reseller.

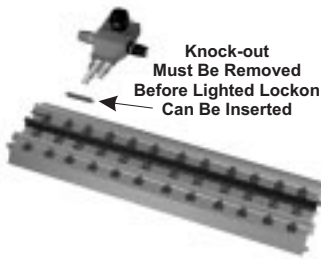

Figure 3: Top view position of lighted lockon preparing to enter RiteTrax® section.

transformer. Each RiteTrax® track section includes a “knock-out” in the roadbed that must be removed to reveal the opening for the

The lighted lockon included in your set snaps into any RiteTrax® track section roadbed and functions as the interface between the track and the

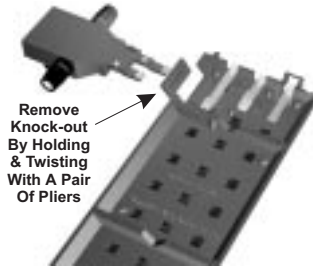

Figure 4: Underside view of RiteTrax® section with “knock-out” removed and lighted lockon in position for insertion.

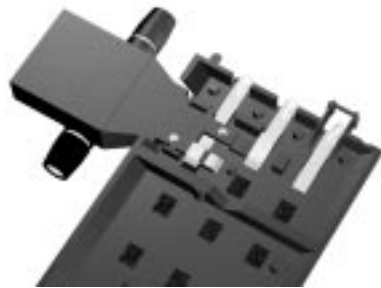

Figure 5: Underside view of RiteTrax® track section with lighted lockon in fully seated position.

lighted lockon. To remove this *knock-out* grab the *knock-out* with a pair of pliers and gently twist the *knock-out* until it snaps away from the roadbed base. Once the *knock-out* has been removed, snap the lighted lockon into the roadbed taking care to make sure that the lockon arms snap into the roadbed electrical receptors. To complete the connection between the RiteTrax® track section and the transformer, simply plug in the color-coded wire harness that was included in your set.



Figure 6: Top view of RiteTrax® section with lighted lockon in fully seated position.

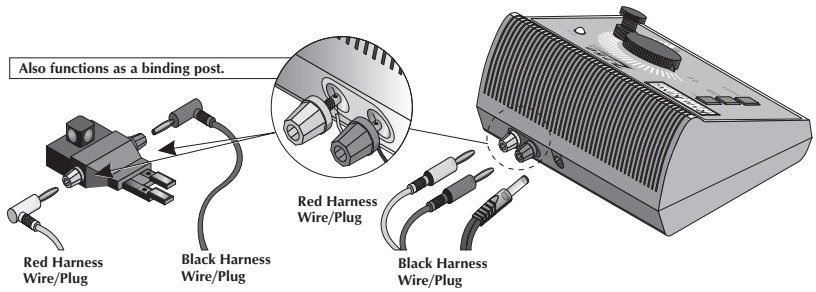

Figure 7: Wiring up the Z-750 transformer to the lighted locomon.

Preparing the Locomotive

Before you fun your locomotive, you **must** oil the locomotive.

Oiling the locomotive

Before you run the locomotive, use a light household or hobby oil to lubricate the gears and pick up rollers. Apply a small drop of oil (a pinpoint oiler will help place the right amount of oil where you need it) to each of the points indicated by in the diagram in Figure 8. You may also what to use either a locomotive repair cradle or an old towel folded over to provide a protective bed for the locomotive shell while you're working on it.

Because the locomotives's internal gearing has been

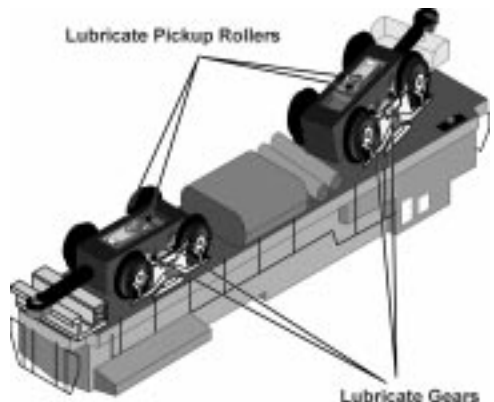

Figure 8: Lubrication points of RailKing Diesel "Work Train" locomotive.

greased at the factory, you shouldn't need to add more grease until you have run the locomotive for 50 hours or owned it for a year, whichever comes first. See the section on lubrication, pages(s) 31-32, for detail.

QuickStart: Operating The Engine and Cars

Once the track has been assembled and the transformer wired to the track lock-on, you are almost ready to begin running your new train set. Place the engine and cars on the track and couple each up to one another. If the coupler is already closed, pressing down on the coupler armature will open the coupler knuckle to allow the couplers to interlock with one another. Before turning on the transformer, it is important to understand the features of your new train set.

**Pushing Down
On The Coupler
Armature Opens
The Coupler
Knuckle**

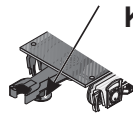

Figure 9: Pushing down on the coupler armature to open up the coupler knuckle.

Electronic Reverse Unit

The locomotive is controlled by a ProtoSound® DCRU® electronic reverse unit. The reverse unit operates in the same manner that all reverse units function by using forward, neutral and reverse states that are entered each time the throttle is turned on and off or by using the transformer direction switch (if so equipped).

The reverse unit is designed to ignore dirty track, dead spots on switches or minor short circuits without disrupting the engine

operation, even at slow, prototypical speeds. Once the engine is placed on the track, the transformer throttle can be advanced. You will see that only the engine's lights come on and two dings from the sound system will chime followed by the air compressor pump sounds. The engine does not run. This is known as the RESET state and is explained in more detail below. The ProtoSound® DCRU® will not power the motor until the throttle is turned OFF and then ON again. At

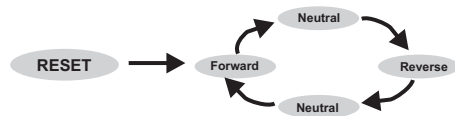

this point, the engine will now function just like any other electronic or mechanical E-unit.

Now, **if you've lubricated the locomotive and passenger car friction points as indicated earlier**, you're ready to start running your train.

Transformer Operation

The Z-750 provides the model railroad enthusiast with an easy to use, safe power source for AC-powered trains and accessories. Set up is quick and easy by following the setup diagram below.

FUNCTIONS:

Bell: Press to activate, press again to deactivate.

Horn/Whistle: Press to activate.

Direction: Press to stop motion of train and press again to change direction

Starting to Roll

Advanced the transformer throttle. The locomotive's light will come on but the engine will not move out in the forward direction until you turn the throttle back OFF and then ON again. At this point, advancing the throttle further will allow the engine to pick up speed, reducing the throttle will slow the engine down. Turning the throttle OFF and then back ON will park the engine into neutral. Cycling the throttle OFF and then back ON again one more time will allow the locomotive to enter reverse.

Figure 10: Z-750 Controls

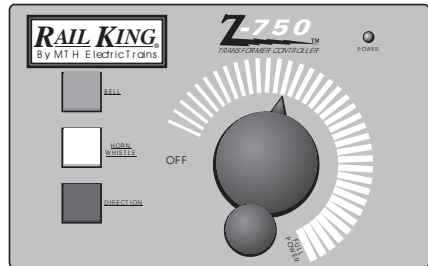

An alternative method to using the throttle to enter the next reverse unit phase is to press the direction button. When depressed, the transformer interrupts all power to the track as long as the button is depressed. Releasing the button reapplies power to the track at whatever voltage level the transformer throttle is set at.

Blowing The Horn

Your Proto-Sound® equipped engine features a digital recording of a Diesel horn. The horn sound can be activated anytime the engine is in forward or reverse by pressing the whistle/horn button on your transformer. The horn will continue to blow as long as the whistle/horn button is depressed. The horn will not function in RESET and must be configured through a RESET option to allow the horn to work when the engine is in neutral. See page 25 for information on horn programming in the ***Using RESET To Program Proto-Sound®*** section of this manual.

Ringling The Bell

Your Proto-Sound® equipped engine also features a digital recording of an actual Diesel engine bell. The bell can be turned on or off by simply pressing the Bell button on your transformer anytime the engine is in forward or reverse. The bell will continue to ring until the bell button is depressed a second time. The bell will not function in RESET. Once the bell is turned on, it will continue to ring when the engine is cycled into forward or reverse until you press the bell button.

Proto-Sound® Tip: Because of Proto-Sound® state-of-the-art design, the microprocessor remembers its last command. Therefore, unless you turn the bell off before you quit running your train, the next time you run the engine, the bell will come on. No matter whether you come back an hour later or a year later, the bell will begin chiming once the engine enters one of the three directional states.

Operating The Remote Controlled ProtoCoupler® Coupler System

Your Proto-Sound® equipped locomotive is equipped with two coil-wound *ProtoCoupler®* for remote uncoupling action. Because the *ProtoCoupler®* is controlled through the Proto-Sound® microprocessor, it doesn't require an uncoupling track section or modification to your layout to function. The three simple steps below are required to operate the coupler.

1. Put your engine in NEUTRAL and turn the throttle all the way up.
2. Press the transformer whistle button to “Arm” the coupler. (You will hear a “Clank”)
3. After arming the coupler, press the whistle button again to open the coupler.

When the knuckle fires open you will hear the buzzing of the coil energizing and the sound of the air lines coming apart. It can best be described as a

CHA-CHUSHHH sound. The coupler doesn't have to be fired in NEUTRAL. Once the coupler is armed it can be fired in Forward, Neutral or Reverse.

However, you may find that the coupler doesn't open when firing the coupler at high speeds. Reduce the voltage setting on your transformer if this occurs and run your engine at a slower speed before firing the coupler. If the coupler continues to open erratically, try lubricating the knuckle with light oil as indicated in Fig. 11.

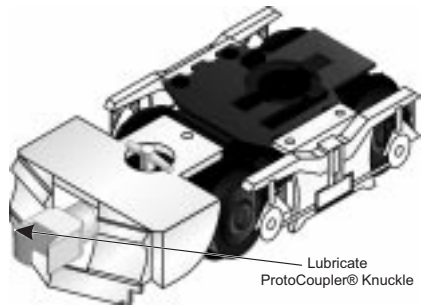
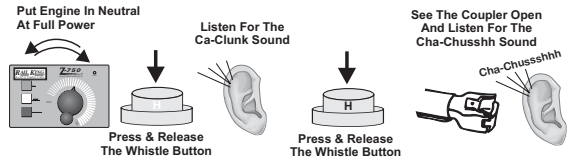

Figure 11: Lubricating the ProtoCoupler® Coupler Knuckle

Because the locomotive features two ProtoCoupler® couplers (one on each end), the operator will have to choose which coupler will be fired when activated. To choose which coupler will be active, slide the coupler selection switch toward the end of the engine you wish to utilize an active ProtoCoupler®.

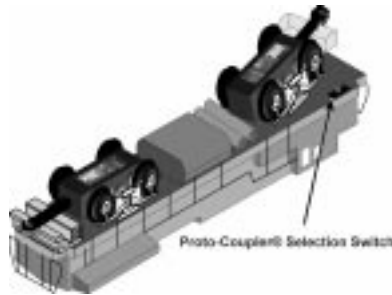

Figure 12: ProtoCoupler® Selector Switch

Diesel Cab Chatter Sounds

Whenever your Diesel locomotive is parked in Neutral randomly played “Cab Chatter” sound effects will occur every 2 to 30 seconds. There are a total of six of these Cab Chatter sequences that capture authentic radio transmissions between dispatcher and engineer. They are designed to play at random intervals to eliminate repetitive and boring sequences though there is no guarantee that you won’t hear the same message repeated twice or more times.

Squeaking Brake Sounds

Proto-Sound® equipped engines feature the ability to play the sound of squeaking brakes whenever your engine slows in speed. There are two settings for activating the squeaking brake sounds. The default setting allows the brake sounds to play while the engine is in forward or reverse and the

transformer throttle is lowered from a high setting to a low setting (14 volts to 8 volts or less). The sound itself is a stored record on the

**Throttle Down From
High Voltage To Low**

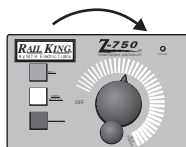

**Listen For The
Squeaking Brake Sounds**

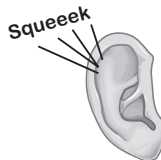

Proto-Sound® software chip and will always play the same brake sound for the same three second length each time the voltage is reduced from high to low. Some practice may be required to synchronize the playing of the brake sounds with the movement of the engine. It is not uncommon for the engine to stop before the brake sound is completed. Operators will find that by coordinating the movement of the throttle setting from 8 volts to off will allow the engine to maintain its movement while the brake sounds play. *Note: The brake sounds will not be heard if the transformer throttle is not set above 14 volts and/or not reduced below 8 volts.*

TIPS ON USING THE SQUEAKING BRAKE FEATURE

Because the squeaking brake feature always plays for approximately 3 seconds, it is possible that the brake sounds will play longer or shorter than what visually seems prototypical. You will find that by practicing with the brake feature, you can quickly determine how quickly to throttle down and what speeds and voltage settings give you the most prototypical braking effect.

Typical users will find the feature to be a very realistic way to simulate the sound of an engine slowing down for curves, crossings or coming to a stop at a station, side track or switch yard. As mentioned above, you will find that initially your engine may continue to play the brake sounds once your engine comes to a stop or that the sounds stop prematurely before the engine comes to a complete halt. For example, if you simply run the engine and turn the throttle off quickly, the brake sounds will likely continue playing even though the engine has come to a complete stop.

This annoying effect can be eliminated by simply practicing with the brake feature. In no time, you will quickly learn how to “feather” the throttle to keep the engine moving while the brake sounds play and then turning the throttle off just as the sounds stop. Remember that once you stop the engine, you should turn the throttle to the off position if you don’t want to activate the Passenger Station Sounds feature described later in this manual.

Operating Proto-Sound® Freight Yard Sound Effects

Freight Yard Sounds(FYS)

ProtoSounds® comes equipped with operator controlled Freight Yard Sounds, hereby referred to as FYS. This easy to use feature plays digitally reproduced freight yard sounds whenever your engine stops on your layout and is parked in the Neutral position. No additional wires or modifications are needed on your layout to enjoy these amazing sound effects. The sounds themselves are randomly generated and randomly “shuffled” on the ProtoSounds® software chip. This gives the system the ability to produce different sounds in a different order each time FYS is enabled. These different sounds are heard each time you cycle the transformer throttle from ON to OFF in the same manner that you would cycle the throttle to enter the various states of Forward, Neutral and Reverse. The entire FYS sequence is designed to simulate the arrival, loading or unloading and departure of a freight train in a freight yard. Each sequence is described in more detail in the following sections.

Activating Freight Yard Sounds

Your ProtoSounds® equipped engine features an operator controlled freight yard sound set. Once activated, this easy to use feature plays the sound of freight yard activities whenever the operator places the engine in the neutral position.

Arming The Freight Yard Feature

Before the freight yard sounds can be heard, ProtoSounds® must activate the feature so that the next time the engine enters the neutral position, the sounds can play. The feature can be activated one of two ways.

Option 1: If you are using a separate bell button controller to ring your bell (like the Lionel Railsounds® No. 5906 bell activation button) you can activate the feature by pressing and holding the bell button for three seconds or longer (it doesn't matter if you are in forward, neutral or reverse). You will hear the bell chiming turn on and if you listen carefully you should hear an air release sound after three seconds have passed at which time you can release the

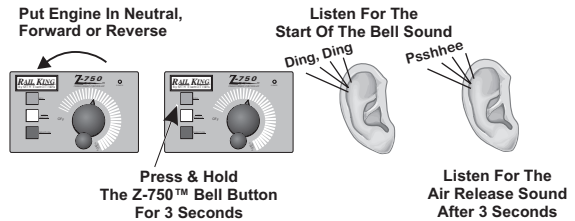

bell button. (**Note:** because the air release sound is hard to hear, we recommend that you count out a full three seconds before releasing the bell button.) The bell will continue to chime, so if you want to turn off the bell ringing, simply press and release the bell button a second time. If you were in neutral when you triggered the brake feature, interrupt the transformer throttle to enter either forward or reverse to allow the engine to begin running. (**Note:** the feature will only be activated in the first direction state you enter after triggering the feature from the neutral position. You cannot interrupt the power twice to enter another direction state and still have the brake feature active.) Once your engine begins running, you can trigger the sounds to begin playing whenever you enter neutral.

Option 2 If you do not have a separate bell button on your layout, you can still activate the feature with your transformer whistle button. To activate the feature turn on the transformer throttle and get your engine into the neutral position (not RESET). Once in neutral, set the transformer throttle at 8 volts or less and press and hold the whistle button for at least three seconds. You will hear the bell chiming turn on and if you listen carefully you should hear an air release sound after three seconds have passed at which time you can release the whistle

button. (**Note:** because the air release sound is hard to hear, we recommend that you count out a full three seconds before releasing the whistle button.) The bell will continue to chime, so if you want to turn off the bell ringing, simply press and release the bell button a second time. Interrupt the transformer throttle to enter either forward or reverse to allow the engine to

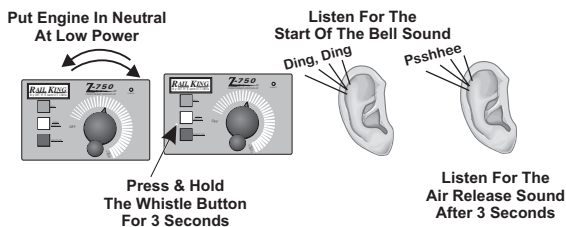

begin running. (**Note:** the feature will only be activate in the first direction state you enter after triggering the feature from the neutral position. You cannot interrupt the power twice to enter another direction state and still have the feature active.) Once your engine begins running, you can trigger the sounds to begin by entering neutral.

Activating and Triggering Freight Yard Sounds

Before FYS can be heard the feature must be activated first. Activation is accomplished by holding down the bell button for three or more seconds as described in the Activating and Triggering The Squeaking Brake Sounds section found earlier. Once the feature is activated, FYS will be played the next time the engine enters the neutral position. In order for FYS to begin, power must remain on once the engine enters the Neutral position. At this point ProtoSounds® has taken over control of your engine and disabled the bell and whistle buttons from any further operator functions. In addition, ProtoSounds® has reconfigured the way the reverse unit functions by disabling the reverse unit state during operation of the FYS feature. This forces the engine to leave your freight yard in the same direction it arrived in. The following operator controlled “events” control FYS’s actions and sounds.

Event 1 (Forward) While the locomotive is running in forward (or reverse) FYS is activated by the operator pushing and holding the bell button down for three or more seconds. The locomotive bell begins chiming and can be left on or turned off without disabling FYS.

Event 2 (Neutral Before Reverse) The operator now interrupts the transformer throttle to stop the engine and put it into Neutral. If the throttle setting was at 14 volts or higher, ProtoSounds® will play the sound of squeaking brake sounds as the engine comes to a halt.

A. Upon stopping of the engine, the operator must immediately turn the throttle back on to keep the engine in the Neutral position. If the bell was not turned off after activating FYS, it now turns off automatically.

Note: Failure to turn the throttle back on within 3 seconds of leaving the Forward phase will disable FYS and shutdown ProtoSounds®. The next time you turn power back on your engine will be in the RESET position. See page 4 for more information on RESET.

**Put Engine In Neutral
At Low Power**

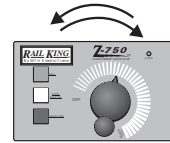

B. After entering Neutral, ProtoSounds® will immediately play an air release sound followed approximately 2 seconds later by a Cab Chatter Arrival Message. The arrival message announces what yard the engine has arrived in (the yard is described as either Yard A or Yard B, alternating each time FYS is enabled during the current operating session. If the engine is turned off for more than three seconds, ProtoSounds® will automatically return to the Yard A message the next time FYS is enabled). Immediately following the arrival message, the sound of freight car doors can be heard opening, followed by the sounds for forklift engines. At this point various freight yard sounds can be heard including forklift operation, engine sounds, reverse warning horn beeps, and additional freight car door sounds.

**Listen For Air Release Sound
And Yard Man Whistling**



Event 3: (Reverse) The operator now interrupts the transformer throttle again to enter the next reverse unit phase; reverse. In an effort to enhance realism, FYS has disabled the reverse phase so that it doesn't power the motors causing the engine to move backward.

Upon entering reverse, FYS confirms to the operator that it has entered the reverse phase by immediately playing a highlight sound best described as a rumbling sound. You may have to go through the entire FYS sequence several times before you can clearly identify this sound. After the rumbling highlight is played, the freight yard sounds heard in Event 2 continue to play randomly.

Interrupt Throttle To Enter The Next Phase

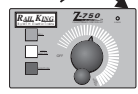

Listen For Rumbling Box Car Door Sound



Event 4: (Neutral Before Forward) The operator now interrupts the transformer throttle again to enter the next reverse unit phase, neutral before forward. FYS confirms to the operator that it has entered the neutral before forward phase by emitting two quick air release sounds. This is followed by a Cab Chatter message that the engine in Yard A or B (whichever yard designation was played in Event 2) is preparing to depart the yard. Upon completion of the cab chatter message, the freight yard sounds change as the forklift sounds turn off and the freight car doors begin shutting.

Interrupt Throttle To Enter The Next Phase

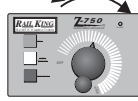

Psshhe, Psshhe



Listen For 2 Air Release Sounds

Event 5: (Forward) The operator now interrupts the transformer throttle again to enter the next reverse unit phase; Forward. FYS confirms to the operator that it has entered the Forward phase by playing the sound of the freight car door closing. Within 2 seconds of the door closing, the locomotive bell begins chiming, the Diesel engine sounds come on and the air compressor pumps start. After

approximately 7 chimes of the bell, the engine begins moving in the forward phase with the bell continuing to ring another 7 chimes before automatically turning off. Once the bell turns off, the operator regains control of the transformer whistle and bell buttons and can ring the bell or blow the horn as usual.

Interrupt Throttle To
Enter The Next Phase



Listen For The Sound
Of Box Door Closing

Note: When entering the Forward phase of FYS, it is important to set the transformer throttle at a high enough setting that will allow the engine to begin moving once FYS automatically activates the motors. Otherwise the engine will just sit still until you increase the transformer throttle setting on the transformer.

TIPS ON USING FYS FEATURES

FYS is a unique feature of ProtoSounds® that is completely controlled by the operator. You decide how, when or if you want to utilize the feature. By reviewing the following tips, you should find solutions or suggestions to the various operating scenarios you might encounter when using FYS.

Tip #1: You can escape the FYS sequence by interrupting the transformer throttle before the first Cab Chatter message plays in Event 2 (neutral before reverse).

Tip #2: You can terminate FYS at anytime by turning the transformer throttle Off for 15 seconds.

Tip #3: You do not have to be in the Forward phase to utilize FYS. For example, if you activate the FYS feature while in Reverse and interrupt the throttle to enter Neutral, you will be entering Neutral Before Forward rather than Neutral Before Reverse as defined in Event 2 above. Consequently, the Forward phase will be rendered inactive by ProtoSounds® instead of the Reverse phase as explained in Event 3. This will allow your train to leave the yard in the same reverse direction that it arrived in.

Tip #4: You can utilize FYS even if you are double-heading with another engine regardless of whether the second engine is equipped with an FYS programmed ProtoSound® module. If the second engine isn't equipped with FYS, the only thing to remember is that you not turn up the transformer throttle very high when entering the Reverse phase found in Event 3. If the throttle is set too high, then the second locomotive will begin vibrating on the track as its motors will be turning in the reverse state since they cannot be disabled automatically like FYS equipped engines. If your second engine is equipped with FYS, you may want to disable it when used in double-headed operations. To disable FYS, see the section on programming RESET functions on page 28 of this manual.

Tip #5: It is not necessary for the squeaking brake sounds to be heard to play the FYS sounds. For example, the brake sounds won't be heard if the high voltage setting is below 13 volts when the power is interrupted to enter the Neutral state.

Tip #6: You can leave any of the event states at any time after entering the state by simply interrupting the transformer throttle. Any sound effects programmed to play in that event will simply not occur. The only exception is Event 2 and Event 5. In Event 2, interrupting the throttle has no effect on FYS until after the arrival Cab Chatter message has completed and the freight car doors have opened. In Event 5, you cannot interrupt FYS until after the engine begins to move. Interrupting the throttle before the engine begins to move has no effect on the locomotive's operation.

Special Reverse Unit Options

Reverse Unit Lockout Operation

Proto-Sound® unique design eliminates the need for a lock-out switch on the locomotive by allowing the customer to lock the engine into any directional state (forward, neutral or reverse) from the transformer. This will allow users to run the engine on layouts equipped with block signals or stop stations which would normally cycle the engine back into neutral. The feature must be first turned on by accessing RESET Feature 40 (See page 22).

Locking The Engine Into Forward or Reverse

To lock the engine into Forward or Reverse, use the transformer throttle to enter Forward or Reverse (whichever state you want to lock the engine into) and while the engine is moving press the whistle button. WHILE THE HORN IS BLOWING TURN THE THROTTLE OFF AND THEN LET GO OF THE WHISTLE BUTTON. After about one second, you will hear a short horn blast. QUICKLY TURN THE THROTTLE BACK ON AGAIN. Your engine is now locked into Forward or Reverse and it will remain so until you unlock the engine, even if you wait a year to run your engine again.

Unlocking The Engine

Unlocking the engine is a similar procedure. WHILE THE ENGINE IS MOVING, PRESS THE WHISTLE BUTTON. WHILE THE HORN IS BLOWING, TURN THE THROTTLE OFF AND THEN LET GO OF THE WHISTLE BUTTON. After three seconds without power you will hear

one chime of the RESET bell. TURN ON THE POWER AGAIN. Your engine is now in RESET and will operate normally once you interrupt power and enter the forward direction.

Locking The Engine Into Neutral

To lock the engine into the NEUTRAL position, PUT THE ENGINE IN NEUTRAL AND WITH THE THROTTLE STILL ON, PRESS THE WHISTLE BUTTON. WHILE THE WHISTLE BUTTON IS BEING PRESSED, TURN OFF THE THROTTLE AND LET GO OF THE WHISTLE BUTTON. After about one second, you will hear a short blast of the horn. QUICKLY TURN THE POWER BACK ON AGAIN. Your engine is now locked into NEUTRAL.

NOTE: *When locking the engine in the Forward or Reverse positions, the whistle button will blow the horn. But when locking the engine into the NEUTRAL position, the whistle button may turn on or off sounds of the bell, coupler arming or coupler firing depending on the transformer throttle voltage settings prior to the user's attempt to lock out the engine. Remember, the horn doesn't blow in NEUTRAL (unless you programmed it to do so using Feature 25. See page 17 for details), only the bell rings or the coupler operates in NEUTRAL. While it doesn't make any difference on how the lockout function operates, you may hear one of the three different NEUTRAL-activated sounds.*

To unlock the engine from the NEUTRAL position, follow the process to unlock the engine in the Forward or Reverse directions above.

Other Proto-Sound® Operating Features

Self-Recharging Battery Backup System

Proto-Sound® state-of-the-art design includes a self-recharging battery backup system for improved performance at any speed. The battery ensures that power to the sound system will remain on during directional changes, setting RESET options or when travelling over dirty track and switches. The self-recharging battery backup system is automatically turned on or off whenever track power is turned on or are off. There no switches needed to enjoy the benefits of the automatic battery backup system.

Proto-Sound® contains a warning alarm if the battery backup system fails to automatically disengage when track power is turned off. Should the backup system fail, you will hear a repeating whistle blast indicating this has occurred. Should this happen, unplug the battery from the

ProtoSound module (to prevent the battery from being run down) and contact MTH for instructions on returning the tender for repair.

Replacing The Proto-Sound® Battery

The Proto-Sound® battery (located in the tender body, is a special NiCad 7-cell, 8.4v battery -NOT the 6-cell, 7.2v battery found in most convenience stores. The 6-cell NiCad is NOT recommended for use with Proto-Sound® applications. The battery is continually charged from the track when power is applied and should last for up to five years. In addition, the NiCad battery is a dry battery and should not leak or cause any damage to your locomotive during its lifetime

If you notice that the sounds seem distorted or garbled at low voltages or become silent when power from the transformer is shut off, the battery may be going bad. Before replacing the battery, you should put the engine in NEUTRAL and leave the transformer throttle set at about 12 volts for 15 minutes. This should temporarily recharge the battery. If the garbled or distorted sounds are reduced, then your battery charge has worn down. You can give your battery a full charge by leaving the engine ON in the NEUTRAL position for 18 hours.

If you need to replace the battery, replacement Proto-Sound® batteries are available from MTH ProtoSound Electronics at 7020 Columbia Gateway Drive, Columbia, MD 21046-1532. A standard 9v alkaline battery can be substituted as a temporary fix, but since alkaline batteries can't take a charge, it will eventually wear down. Regardless, it should give you a week to a couple of months use while you wait for your replacement Proto-Sound® battery to arrive.

Manually Adjusting The Proto-Sound® Volume

Your Proto-Sound® system has two types of volume adjustment. A manual turn knob on the bottom of the chassis (See Fig. 13 below) allows you to control all the sounds in the system and a remote control "RESET" option (Option # 6), allows you to control the volume level of the engine sounds remotely from the transformer. Turning the volume adjustment knob clockwise will increase the volume and counterclockwise will lower the volume of all sounds; bell, horn, engine sounds, Cab Chatter, etc. For information on operating the RESET volume adjustment option, see the section entitled "Programming Proto-Sound® RESET Options" on the following pages.

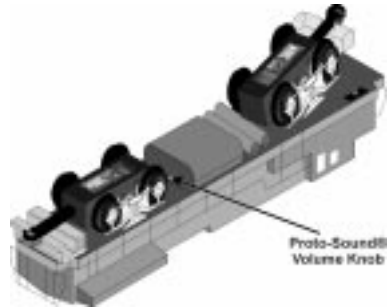

Figure 13: ProtoSound® Manual Volume Adjustment Knob

Operating & Programming Proto-Sound® Programmable Features

As mentioned in the Basic Operating section, the engine is controlled by a DCRU® reverse unit that contains the standard forward-neutral-reverse states found on most reverse units. However, when power is first applied to the track, the reverse unit begins in RESET or what seems like a neutral state. Power must be interrupted again to get the locomotive to enter the forward state. It is this first RESET state that gives Proto-Sound® its unique, remote controlled functions. The system will enter RESET whenever power to the track is off for three or more seconds. NEUTRAL will be referred to as the state between Forward and Reverse.

Proto-Sound® is equipped with a microprocessor, that, depending on the amount of memory it is allotted, allows the user to utilize several remotely activated functions. In the simplest terms, Proto-Sound® has its own "Computer" controlling these functions. In fact, the power of this microprocessor is the same as that of a 286 desktop computer!

In order to access many of these remotely controlled functions, the user must be in the RESET state to do so. RESET is entered anytime power to the locomotive has been off for more than 3 to 5 seconds. When the engine first enters RESET, the microprocessor initiates a system check to determine if the system, transformer and engine are operating correctly. This takes approximately 2.2 seconds during which you will hear the engine's startup sounds begin. In order for Proto-Sound® to properly initiate the system check, do not advance the transformer throttle past 10 volts when you first enter RESET, wait for the diesel startup sounds to begin and then slowly turn the transformer throttle to the off position and then back on again to enter the forward phase. Interrupting the power too quickly may cause the system to re-enter RESET (signaled by two dings of the bell). Should this happen, wait longer before interrupting the power to enter the Forward phase.

Proto-Sound® also comes with several programmable functions, including remote Diesel Engine Volume Adjustment, Separate Bell Button Operation (pre-programmed at the factory), Horn In Neutral Operation, ProtoCoupler® On/Off Control, Squeaking Brakes and Passenger Station Proto-Effects™. Each of these features are described in more detail in the following sections.

When in RESET, your engine will not respond to the whistle/horn or bell button with a horn blast or continuous bell ringing. In fact, when in RESET and the whistle/horn or bell button is depressed, only one single bell chime will be heard each time either button is pressed. If you don't want to configure or change your locomotive using any of the above programmable features, simply leave RESET (waiting 2.2 seconds before interrupting the power) and put the engine into forward. After you leave RESET, your engine will operate normally in all the direction states of forward, neutral and reverse. Remember though, once power is turned off for more than 3 seconds, the next time power is applied to the track, your engine will be back in RESET.

Using RESET To Program Proto-Sound®

While Proto-Sound® is equipped with only a few programmable features, additional memory chips can be obtained to “Upgrade” the system in the future. Programmable features are accessed in the RESET state by moving the transformer throttle up and down between full voltage and low voltage (6 to 8 volts) without shutting the transformer off completely. Each time this is done you advance, one feature at a time, through the available options. An air-release sound is heard each time the throttle is advanced. In addition, there are special sounds to tell you what RESET position you are in.

For example, if you want to select

Feature 2, you put

the engine in RESET, and move the throttle up and down from full throttle to low two times. After the second advance, you will hear two “clinks” indicating that the computer is now in Feature 2. Advance the throttle again and you will hear three “clinks” for Feature 3. Advance it two more times and you will hear a “clank” indicating that you are now in Feature 5. Advance the throttle two more times and you will hear a “clank” and two “clinks” indicating Feature 7. ((5 throttle advancements = 1 clank) + (2 throttle advancements = 2 clinks)). “Clank + “Clink” + “Clink” = Feature 7. You can advance the throttle as quickly as you like (though you may not hear the air-release sounds) and the computer will still remember the number of times the throttle is advanced by playing back the number of “Clinks” and “Clanks” to confirm the feature you’ve selected.

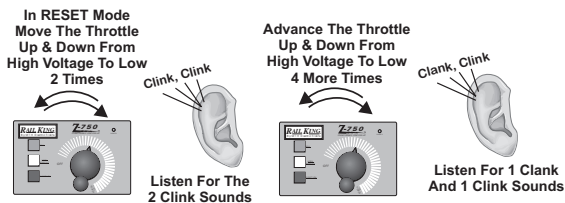

Remotely Adjusting The Engine Volume

Of all the sounds that come with each Proto-Sound® equipped locomotive, the one most often turned down is that of the engine volume because it is the one sound normally heard whenever the engine is running and is what usually can become tiresome to the ear over prolonged running sessions. The volume adjustment is controlled through RESET Feature 6.

To access the feature, advance the transformer throttle to put the engine in RESET. Move the throttle up and down, as described on page 5, 6 times. After you hear the “clank” and “clink” indicating that you are in Feature 6, press the whistle button to select the engine volume level you desire. Pushing the whistle button once will give you full volume, which is the factory setting.

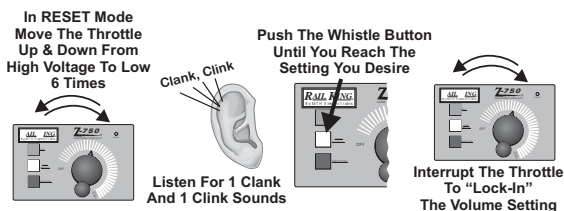

Pushing the whistle button a second time will give you 50% volume, pushing it a third time will give you 25% volume and pushing it a fourth time will give you no diesel. The microprocessor will immediately play the sound level each time the whistle button is pushed so that you can decide if it is acceptable. You can recycle through the four choices by simply continuing to press the whistle button.

Once you have decided on the appropriate volume level, turn the transformer throttle off and on again or press the transformer direction switch to lock in your selection. The volume adjustment will remain set at the level you have chosen until you change it again. Regardless of the engine volume setting, the horn, bell, compressor and Cab Chatter sounds will function normally. In fact because only the engine volume is affected by selections in Feature 6, when you select 0 volume, you can still hear the horn, bell and Cab Chatter sounds when the engine is running or in neutral.

Bell Button Programming

If the engine is being operated with another transformer that does not feature a separate bell button, the engine can be programmed to work with an after-market bell button, like the Lionel® Railsounds™ No. 5906 Bell Button. If no separate bell button can be obtained, the bell can be controlled through your transformer’s whistle button whenever the engine is in NEUTRAL. (Remember NEUTRAL is the state between Forward and Reverse). See page 17 for information on bell programming in the **Using RESET To Program Proto-Sound®** section of this manual.

To turn the bell on using the transformer’s whistle button, turn on power to the track and cycle the engine into NEUTRAL. Turn the

throttle to 8 volts or less (any higher voltage will arm the ProtoCoupler® - see the section above) and press the whistle button. The bell should begin chiming. To turn the bell off, press the whistle button again. If you want to keep the bell on while running the engine, simply interrupt the power with the transformer throttle or the transformer directional switch and enter forward or reverse.

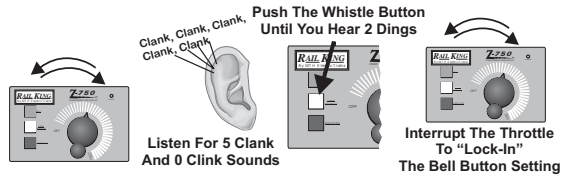

Programming For Squeaking Brake Operation

Proto-Sound® can be programmed for squeaking brake operation in three different manners; (1) Squeaking brakes can be activated by bell button control, (2) they can be programmed for continuous operation subject to throttle changes or (3) they can be programmed to be turned off. The default setting is (1) Squeaking brakes are activated by bell button control as described on page 8. To change the default setting, enter RESET and go to Feature 45. (See the section **Using RESET To Program Proto-Sound® on page 24**). Once in

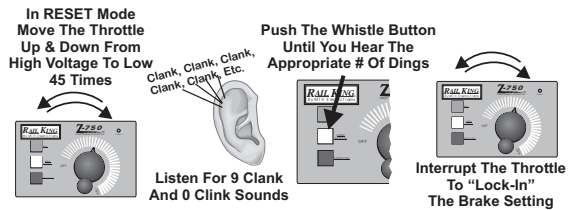

Feature 45, press the whistle button and wait for the module to sound a bell ding(s). Continue pressing the whistle button until the module plays back two dings for option 2 - Squeaking brakes on all the time, subject to throttle movements. Press the whistle button again until the module plays back three dings for option 3 - Squeaking brakes off. Once you have decided on the desired setting, simply turn the throttle off and then on again to "Lock-In" the new setting. To reset the computer to its original factory default setting (option 1 - squeaking brakes activated by bell button controller), repeat the above procedure but keep pushing the whistle button until the module only responds with one bell ding.

Programming For Horn In Neutral Operation

If you are operating your engine with a separate bell button and want to blow your horn when your engine is in neutral, you will need to program Proto-Sound® to do so as the factory setting only allows the horn to blow in forward or reverse.

To do this, enter RESET and go to Feature 25. (See the section **Using RESET To Program Proto-Sounds®** on page 24.) Once in

Feature 25, press the transformer whistle button and wait for Proto-Sound® to sound a bell ding(s). Continue pressing the whistle button until Proto-Sound® sounds two bell dings (signifying that Proto-Sound® has been programmed to sound the horn in neutral). Turn the throttle off and then on again to “Lock-In” your selection. Now, whenever you are in neutral, you can blow the horn with the transformer whistle button. To reset Proto-Sound® to its original factory setting of no horn in neutral, repeat the above procedure but keep pressing the whistle button in Feature 25 until Proto-Sound® only dings once instead of twice.

Note: When “Whistle In Neutral” is set, the bell will only operate with a separate bell button and the horn will not sound in neutral if the transformer throttle setting is over 11 volts. At 11 volts or higher, Proto-Sound® may arm the coil coupler for operation whenever the whistle button is pressed and the engine is in neutral.

Programming For ProtoCoupler® Operation

Proto-Sound® comes with a RESET feature that allows the operator to remotely turn off the ProtoCoupler® functions. This is especially useful when double or triple-heading Proto-Sound® equipped engines since every engine equipped with a ProtoCoupler® will fire when prompted to by the operator.

By turning off the ProtoCoupler® operation on certain engines, you can fire the couplers open on the other engines without uncoupling

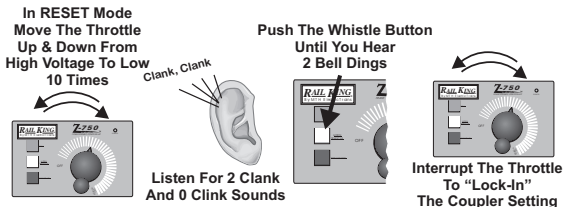
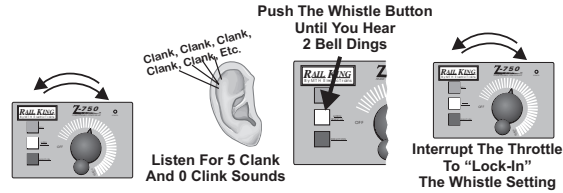

the engines from each other. To turn the ProtoCoupler® function off, enter RESET and go to Feature 10. (See the section on **Using RESET To Program Proto-Sound®** on page 24.) Once in Feature 10, press the transformer whistle button and wait for Proto-Sound® to sound a bell ding(s). Continue pressing the whistle button until Proto-Sound® sounds two bell dings (signifying that the ProtoCoupler® option has been turned off). Simply turn the transformer throttle off and then on again to lock in the new setting.

Turning Off Cab Chatter Sounds

“Cab Chatter” sounds occur in the neutral position every 2 to 30 seconds. There are four “Chatter” messages which play at random times. This helps to eliminate repetitive and boring messages. While the sounds are selected to play randomly by the unit’s computer, there is no guarantee that you won’t hear the same message repeated twice or more times. If you don’t want to hear the Cab Chatter sounds, they can be turned off through Feature 23. To turn

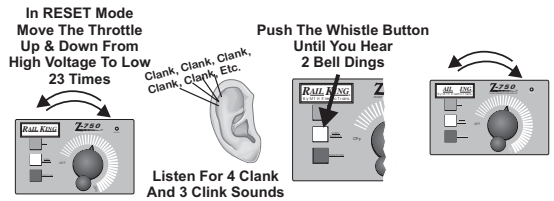

off the Cab Chatter sounds, enter RESET and go to Feature 23. (See the section **Using RESET To Program Proto-Sound®** on Page 24.) Once in Feature 23, press the transformer whistle button and wait for ProtoSounds to sound a bell ding(s). Continue pressing the whistle button until Proto-Sound® sounds two bell dings (signifying that the module has been programmed to turn the Cab Chatter off). Simply turn the transformer throttle off and then on again to lock in your selection. To turn the Cab Chatter sounds back on again, repeat the above process, but keep pressing the transformer whistle button in Feature 23 until Proto-Sound® only sounds one bell ding.

Programming For Squeaking Brakes And PFA Operation

Proto-Sound® is equipped with a RESET setting to turn off the Passenger Station Proto-Effects (PFA) features. This is especially useful if you are double-heading engines that are both equipped with PFA. You may not want to stop at a station and have both engines playing their PFA sound effects. To turn off PFA, enter RESET and go to Feature 28.

(See the section on **Using RESET To Program Proto-Sound®** on page 24). Once in Feature 28, press the transformer whistle button and wait for Proto-Sound® to sound a bell ding(s). Continue pressing the whistle button on and off until Proto-Sound® sounds two bell dings (signifying that the PFA features have been turned off). Simply turn the transformer throttle OFF and then ON again to lock in the new setting. To reset Proto-Sound® to its original factory setting of Squeaking Brakes and PFA on, repeat the above procedure but keep pressing the whistle button in Feature 28 until Proto-Sound® only dings once instead of twice.

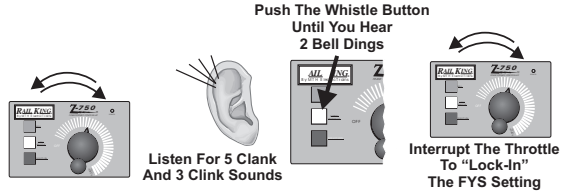

Activating Remote Lock-Out Control

Proto-Sound® equipped engines feature a RESET setting that allows the operator to remotely “lock” the engine into forward, neutral or reverse. This is especially useful on layouts that feature “blocked” track sections. The lockout feature comes from the factory in the OFF position, meaning it is not active when you first take the engine out of the box. This is done to prevent novice operators from accidentally locking their engine into forward, neutral or reverse and then

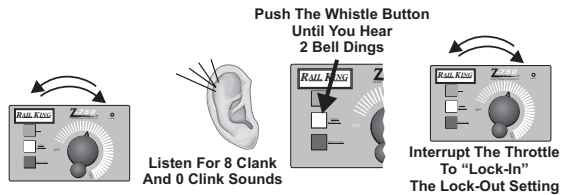

mistakenly thinking that the engine’s electronics have failed. To activate the Remote Lockout Control setting, go to RESET Feature 40 (See the section entitled **Using RESET To Program Proto-Sound®** on page 24). Once in Feature 40, press the transformer whistle button and wait for Proto-Sound® to sound a bell ding. Continue pressing the whistle button until Proto-Sound® sounds two bell dings signifying that the Remote Lockout Control has been selected. To lock in the setting, simply turn the throttle all the way off and then back on again. To turn the Remote Lockout Control setting back off, go back to Feature 40

and press the whistle button until only one bell ding sounds. To lock in the setting, simply turn the transformer throttle off and then back on again. Alternatively, you can go to RESET Feature 18 to reset all Proto-Sound® features back to their original factory defaults including Remote Lockout Control.

Resetting All Proto-Sound® Options To Factory Defaults

Proto-Sound® is equipped with a RESET feature (Feature 18) that resets all programmable options back to their original factory settings. This is a useful feature if you find your engine not operating the way you think it should and don't want to take the time to check each RESET feature one at a time. To reset all the RESET features back to their original factory settings, enter RESET and go to Feature 18. (See the section entitled ***Using RESET To Program Proto-Sounds®*** on page 24). Once in Feature 18, press the transformer whistle button and wait for Proto-Sound® to sound a garbled bell sound.

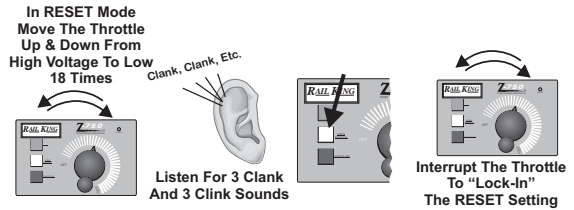

Train Set Maintenance Instructions

Proper locomotive performance requires regular attention to lubrication. The following guidelines should be followed to ensure that your set's locomotives and cars last for many years.

Oil

Before operating the locomotive, apply a small drop of oil to lubricate the gears and pick up rollers. Use light household oil and apply sparingly only to the points indicated by "L" in figure [8] on page 6. Wipe away any excess, especially if oil spills onto the finish of the

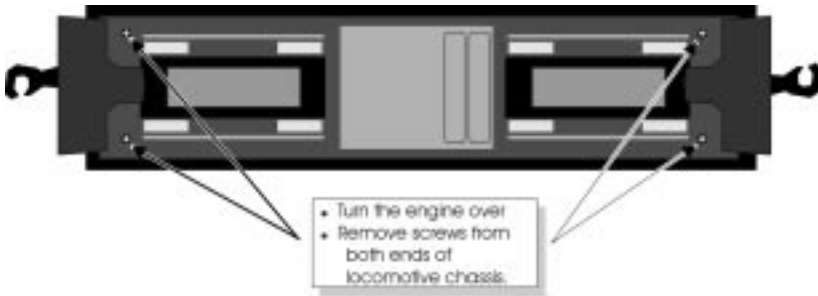

Figure 14: Removing the Diesel "Work Train" locomotive shell from the chassis.

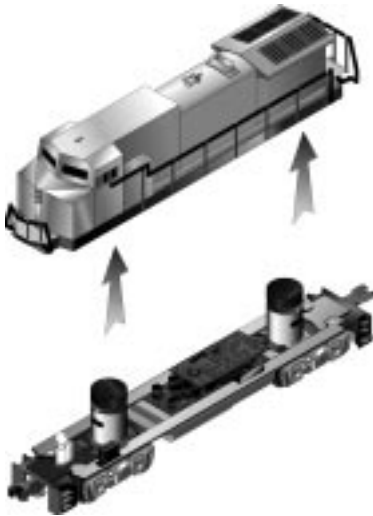

Figure 15: Lifting the body away from the chassis.

locomotive. To prevent accidental scratches or other damage to the locomotive shell while you are working, you may want to place the locomotive in a repair cradle or an old towel or other cloth folded to provide a firm but soft resting place.

Check the locomotive oiling points periodically to be sure they are moving freely and quietly. If they are not, apply small

amount of oil again. Also check locomotive wheels for dirt build up that can cause performance problems. Such dirt build up can interfere with electrical contacts, reduce traction (especially on elevated track sections), and cause neprene traction tires to wear out prematurely.

Grease

Your locomotive's internal gearing has been greased at the factory and should not need additional grease until you have run the locomotive for over 50 hours or owned it for a year, whichever comes first.

Add grease by inserting it into the gear box inside the locomotive chassis. To reach the gear box, remove the cab from the chassis by unscrewing the four chassis screws as indicated in figure [14] on page [31]. Once you have removed the cab, remove the truck mounting screws holding the truck to the motor. After removing this motor mount screw, lift the motor away from the truck and use a grease tube dispenser to coat the bronze drive gear inside the truck and the motor worm gear on the motor. Reinsert the motor down into the truck and reinstall the motor mount screws. Then fit the cab back in place and reinsert the four chassis screws.

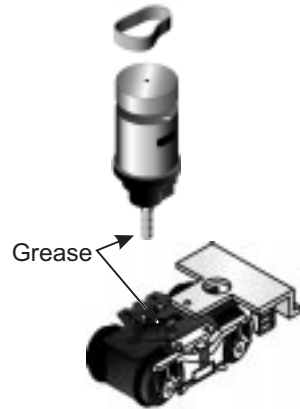

Figure 16: Grease Lubrication Points

Locomotive Lamp Replacement

Your locomotive and freight cars may occasionally burn out their headlights and/or interior lights. Should this occur, you will need to remove the body from the chassis in order to replace the burned out bulb.



Figure 17: Removing the locomotive headlight bulb.

To remove the diesel “Work Train” cab from its chassis, follow the body removal instructions on the previous pages. Once the body has been removed, push the headlight bulb downward and rotate it counter-clockwise as seen in Figure to remove the burned out bulb.

Caboose Car Lamp Replacement

To remove a caboose car body from its chassis, turn the car over and locate and remove the four mounting screws (as seen in Figure 19) attaching the body to the chassis. Once the screws are removed, gently lift the car body up and away from the chassis as seen in Figure 19.

Figure 19: Lifting the caboose car body away from its chassis.

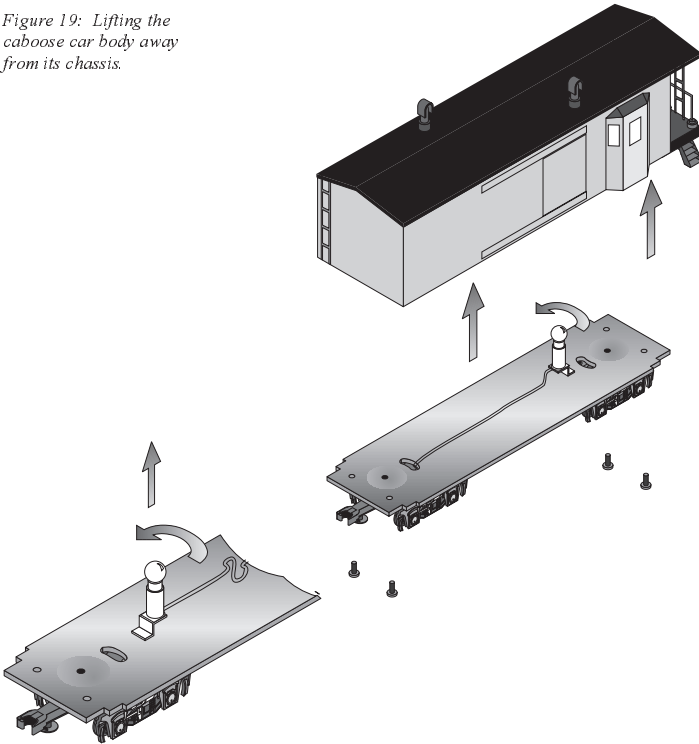

Figure 20: Removing the caboose car interior bulb.

After removing the body from its chassis, locate the car interior lamp housing mounted on the inside of the car chassis. Remove the burned out interior bulb by turning and pulling the bulb away from its housing (see Figure 20). To replace the bulb, simply insert and twist the replacement bulb into the empty lamp housing and reassemble the car body to its chassis.

Locomotive Traction Tire Replacement

Your locomotive is equipped with four neoprene rubber traction tires (two on each power truck). While these tires are extremely durable and long-lasting there may arise a time where they will need to be replaced. Should this occur, you will need to remove the trucks from the chassis in order to slip the new tire over the grooved drive wheel. Follow the lubrication instructions on the previous pages for removing the trucks from the chassis. Once the trucks have been removed, you will need to remove the trucksides in order to gain free access to the wheels and the rubber traction tire grooves. See Figure 21 to remove the trucksides.

Before the new tire can be installed, you must make sure the old tire has been completely removed from the groove in the drive wheel. Use a razor blade or small flatblade screwdriver pry away any remains left from the old tire that may still be in the drive wheel groove. Once the old tire has been completely removed, slip the new tire onto the wheel. You may find it useful to use two small flatblade screwdrivers to assist you in stretching the tire over the wheel. Be

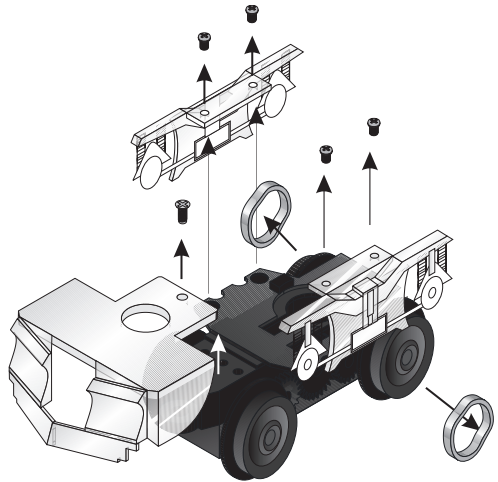

Figure 21: Locating and removing the passenger car interior bulbs.

careful to avoid twisting the tire when stretching it over the wheel. If a twist occurs, the tire will have to be removed and reinstalled or a noticeable wobble in your engine will occur when operating the locomotive. In addition, it is important to make sure that the tire is fully seated inside the groove. Any portion of the tire extending out of the groove can cause the engine to wobble. A razor blade can be used to trim away any excess tire that doesn't seat itself inside the groove properly.

Replacement tires are available directly from MTH Electric Trains.

RiteTrax® Layout Plans

The following track plans are just some of the many different track plans you can utilize when designing your model railroad. Each track plan contains a table indicating which track components and how many you will need to purchase. Some track plans may require additional transformer power to accommodate the current draws of the various accessories featured in the layout, including switches and lights.

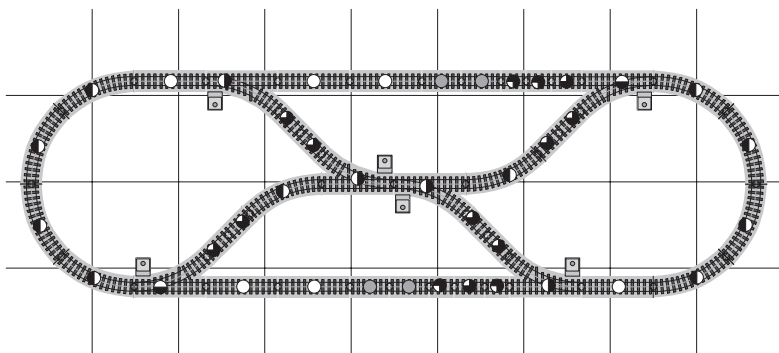

Track List:

	Item #
(6) ○ 10" Straight	(40-1001)
(10) ● O-31 Curved	(40-1002)
(4) ● O-31 Right Hand Switch	(40-1004)
(2) ● O-31 Left Hand Switch	(40-1005)
(4) ● 5.5" Straight	(40-1012)
(10) ● 4.25" Straight	(40-1017)
(4) ● 3.5" Straight	(40-1018)

Approximate Layout Size:

102" x 32" (2.6m x 0.8m)

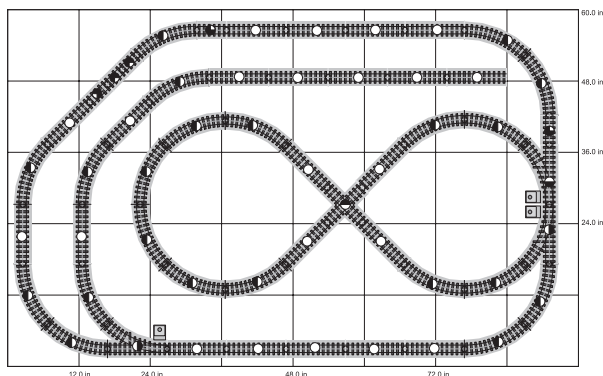

Approximate Layout Size:

96" x 60" (2.4m x 1.5m)

inXside.mt
size: 8.00 x 8.00
track sections: 52

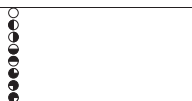

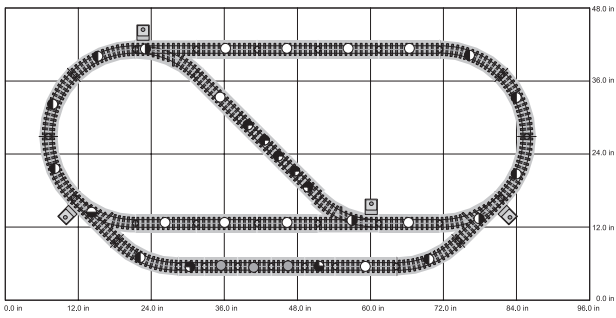

Track List:	Item #
(10) ○ 10" Straight	(40-1001)
(8) ● O-31 Curved	(40-1002)
(3) ● O-31 Right Hand Switch	(40-1004)
(1) ● O-31 Left Hand Switch	(40-1005)
(3) ○ 5.5" Straight	(40-1012)
(1) ● 5.0" Straight	(40-1016)
(2) ● 4.25" Straight	(40-1017)
(4) ● 3.5" Straight	(40-1018)

Approximate Layout Size:
54" x 42" (2.1m x 1.1m)

inrevs31.rtf
size: 8.00 x 4.00
track sections: 32

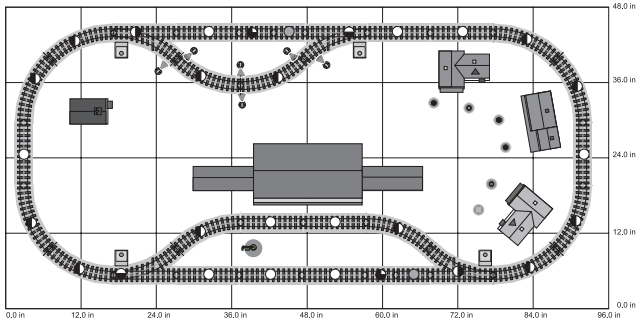

Track List:	Item #
(10) ○ 10" Straight	(40-1001)
(12) ● O-31 Curved	(40-1002)
(2) ● O-31 Right Hand Switch	(40-1004)
(2) ● O-31 Left Hand Switch	(40-1005)
(2) ○ 5.5" Straight	(40-1012)
(2) ● 5.0" Straight	(40-1016)

Approximate Layout Size:
92" x 42" (2.3m x 1.1m)

inbndng5.rtf
size: 8.00 x 4.00
track sections: 30

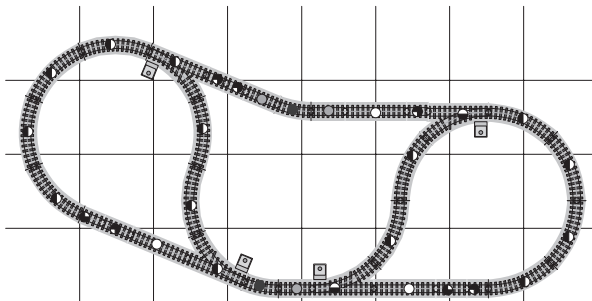

Track List:	Item #
(3) ○ 10" Straight	(40-1001)
(12) ● O-31 Curved	(40-1002)
(2) ● O-31 Right Hand Switch	(40-1004)
(2) ● O-31 Left Hand Switch	(40-1005)
(3) ○ 5.5" Straight	(40-1012)
(5) ● 5.0" Straight	(40-1016)
(2) ● 3.5" Straight	(40-1018)
(2) ● O-31 Half-Curved	(40-1022)

Approximate Layout Size:
95" x 48" (2.4m x 1.2m)

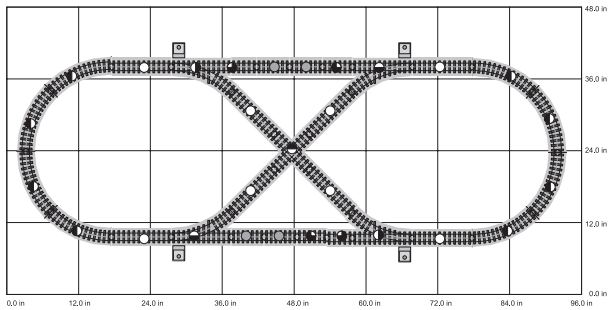

Track List:

	Item #
(8) 10° Straight	(40-1001)
(8) O-31 Curved	(40-1002)
(2) O-31 Right Hand Switch	(40-1004)
(2) O-31 Left Hand Switch	(40-1005)
(1) 90 Degree Crossing	(40-1006)
(4) 5.5° Straight	(40-1012)
(2) 5.0° Straight	(40-1016)
(2) 4.25° Straight	(40-1017)

Approximate Layout Size:

92" x 36" (2.3m x 0.9m)

OvatKrt
size: 8.20 x 4.00
track sections: 37

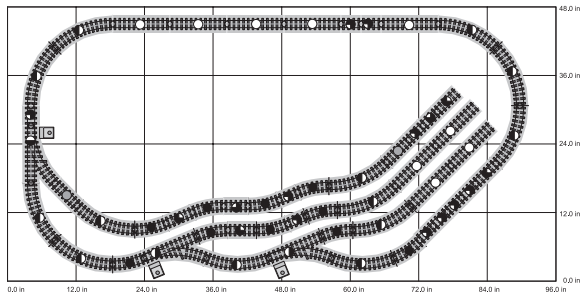

Track List:

	Item #
(9) 10° Straight	(40-1001)
(13) O-31 Curved	(40-1002)
(2) O-31 Right Hand Switch	(40-1004)
(1) O-31 Left Hand Switch	(40-1005)
(2) 5.5° Straight	(40-1012)
(4) 5.0° Straight	(40-1016)
(2) 4.25° Straight	(40-1017)
(10) O-31 Half Curved	(40-1022)
(10) 3.5° Straight	(40-1018)

Approximate Layout Size:

90" x 46" (2.3m x 1.2m)

Source1.rkt
size: 6.00 x 4.00
track sections: 53

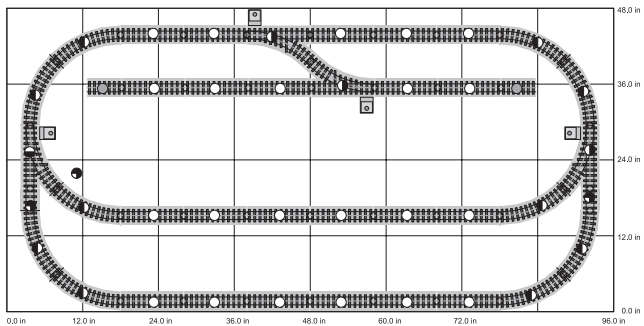

Track List:

	Item #
(22) 10° Straight	(40-1001)
(10) O-31 Curved	(40-1002)
(3) O-31 Right Hand Switch	(40-1004)
(1) O-31 Left Hand Switch	(40-1005)
(2) 5.5° Straight	(40-1012)
(2) 3.5° Straight	(40-1018)

Approximate Layout Size:

96" x 48" (2.4m x 1.2m)

Sliding.rkt
size: 8.20 x 4.00
track sections: 40

TRANSFORMER COMPATIBILITY AND WIRING CHART

ProtoSounds® is designed to work with any standard AC transformer that uses a “Pure Sine-Wave” format. The chart below lists the many Lionel® compatible transformers, such as the Lionel KW or ZW models. In addition, the chart details how the terminals on these compatible transformers should be attached to your layout. The Trainmaster system from Lionel® will not function correctly with ProtoSounds® without disrupting the sound effects. Therefore, whenever ProtoSounds® senses that the Trainmaster system is being used, it automatically disables ProtoSounds® sound effects. The operator retains control over the engine, but no sound effects will play.

Transformer Model	Center Rail	Outside Rail	Min/Max. Voltage	Power Rating	Transformer Type
Lionel 1032	U	A	5-16v*	90-Watt	Standard**
Lionel 1032M	U	A	5-16v*	90-Watt	Standard**
Lionel 1033	U	A	5-16v*	90-Watt	Standard**
Lionel 1043	U	A	5-16v*	90-Watt	Standard**
Lionel 1043M	U	A	5-16v*	90-Watt	Standard**
Lionel 1044	U	A	5-16v*	90-Watt	Standard**
Lionel 1053	U	A	8-17v	60-Watt	Standard**
Lionel 1063	U	A	8-17v	60-Watt	Standard**
All-Trol	Left Terminal	Right Terminal	0-24v	300-Watt	Electronic^A
Cab-1/Powermaster	A	U	0-18v	135V. A.	Electronic^A
Dallee Hostler	Left Terminal	Right Terminal			
Lionel LW	A	U	8-18v	75-Watt	Standard**
Lionel KW	A or B	U	6-20v	190-Watt	Standard**
MRC Tech II	Left Terminal	2 nd From Left	0-15v*	40V. A.	Electronic
Lionel MW	Outside Track Terminal	Inside Track Terminal	5-16v*	50V. A.	Electronic
R. O. W.	Red Terminal	Black Terminal	0-24v	384-Watt	Standard**
Lionel RS-1	Red Terminal	Black Terminal	0-18v	50V. A.	Electronic
Lionel RW	U	A	9-19v	110-Watt	Standard**
Lionel SW	U	A	Unknown	130-Watt	Standard**
Lionel TW	U	A	8-18v	175-Watt	Standard**
Lionel ZW	A, B, C or D	U	8-20v	275-Watt	Standard**
Lionel Trainmaster	Red Terminal	Black Terminal	0-18v	135-Watt	Electronic
MTH Z-500	Red Terminal	Black Terminal	0-18v	50-Watt	Electronic
MTH Z-750	Red Terminal	Black Terminal	0-21v	75-Watt	Electronic
MTH Z-4000	Red Terminal	Black Terminal	0-22v	400-Watt	Electronic

TROUBLE SHOOTING *PROTOSOUND*[®] PROBLEMS

Although ProtoSound[®] has been designed and engineered for ease of use, some questions may arise during initial operation. The following table should answer most questions. If you find that your problem can't be resolved with this manual, contact MTH ProtoSound Electronics (7020 Columbia Gateway Drive, Columbia, MD 21046, 410-381-2580) for additional assistance.

HORN PROBLEMS	REMEDY
The horn seems distorted at low voltages.	Your battery may be undercharged or dead. Try recharging the battery as explained in the battery sections.
When I press the whistle button, the bell comes on instead.	You are trying to operate the horn in neutral. The horn will only operate in Forward or Reverse unless you program ProtoSounds through Feature 25. See the instructions in the section entitled "Using RESET to Program ProtoSounds".
I can't get the horn to blow when I press the whistle button.	You may be pressing the whistle button too quickly. Most older AC transformers contain a two-step whistle button that releases a DC signal onto the track. It is this DC signal that tells the horn to blow. However, because the signal is weaker when the whistle button is depressed fully, the ProtoSound circuit may not recognize the signal. Try pressing the whistle button slower, taking approximately 1 second to fully depress the button.
BELL PROBLEMS	REMEDY
When I press the whistle button to activate the bell, the horn sounds.	You are trying to ring the bell in Forward or Reverse. The bell only operates in Neutral unless you have programmed ProtoSounds to recognize a separate bell button.
When I press the whistle button to activate the bell, I arm the coupler.	Reduce the voltage on the transformer before pressing the whistle button to activate the bell. The bell will only come on at 8 volts or less.
When I press the whistle button to activate the bell, the bell only rings once.	You are trying to ring the bell in RESET instead of neutral. Interrupt the power twice to enter Neutral, set the voltage at 8 volts or less and press the whistle button to activate the bell.
I can't get the bell to ring when I press the whistle button.	You may be pressing the whistle button too quickly. See the 3rd remedy in the horn section above.
The bell won't work with a separate bell button.	ProtoSounds must be programmed in order for a separate bell button to function. Enter RESET function number 20 (see the section entitled "Using RESET to Program ProtoSounds") and press the whistle button until the bell sounds two dings. Simply turn the throttle off and then on again to lock in the new setting.

COUPLER PROBLEMS	REMEDY
The ProtoCoupler won't let the engine uncouple on the "Fly".	The power required to fire the coupler open when the engine is on the "Fly" may be greater than the ProtoSound system is capable of providing. As a result, you may experience times when the coupler won't fire open. Unfortunately, the only solution is to stop the engine and fire the coupler in Neutral. If that doesn't resolve the problem, try lubricating the coupler knuckle and rivet as explained in the ProtoCoupler Operation section.
I can't get the coupler to arm or fire open when I press the whistle button.	You may be pressing the whistle button too quickly. See the third remedy in the horn section above. Another possibility is that ProtoSounds has been programmed to turn the coupler function off. See the section entitled "Using RESET to Program ProtoSounds"
Only one coupler will function when I press the whistle button.	Only one coupler can operate at any one time. Use the coupler selection switch on the bottom of the chassis to choose which coupler you want active.
Diesel START/CAB CHATTER	REMEDY
Sometimes the Diesel start sounds don't occur when I first turn power on.	Occasionally the Diesel engine start up sounds may not occur when power is turned back on within 5 seconds of being shut off. Wait 10 -- 15 seconds before reprogramming.
Sometimes the Cab Chatter sounds don't play.	The Cab Chatter sounds only play in neutral and ProtoSounds may be programmed to turn the sounds off. See the section entitled "Using RESET to Program ProtoSounds"
LOCKOUT PROBLEMS	REMEDY
I can't get the engine to run after I power up the transformer. It sits still with the Diesel compressor sounds running.	The engine is locked out into the Neutral position. Follow the unlocking procedures in the Lockout Section.
The engine won't lock out into Forward, Neutral or Reverse even after the short horn blast sounds.	You are waiting too long to turn the throttle back on after the short horn blast sounds. The power must be turned back on immediately after the short horn blast sounds or the engine will go back into RESET. See the lockout procedure in the Lockout Section.
VOLUME PROBLEMS	REMEDY
When I try to run the engine, the Diesel volume is OFF or very low.	The Diesel volume has been programmed at a reduced volume or to be silent. Go to RESET Feature 6 and adjust the volume. See the section entitled "Using RESET to Program ProtoSounds" for more information.
When I try to set the Diesel volume, it resets itself to the original volume after I selected the new volume.	You are trying to set the volume with a poorly charged or dead backup battery. See the section on Battery Backup for more information.
When I try to set the Diesel Volume to 0 Volume, I still hear the cab chatter sounds.	When the Diesel volume is set to 0, you will hear the Cab Chatter sounds because setting the Diesel volume only controls the sound of the Diesel engine itself. All other sounds, including Cab Chatter, the horn and bell will continue to play at the volume level set by the manual volume control knob located on the bottom of the chassis. See the section entitled "ProtoSound Volume Adjustment" for more information.
The sounds seem distorted, especially when the whistle or bell is activated.	The overall ProtoSound volume has been set to high creating the distorted sounds. Try turning the volume control knob located on the bottom of the chassis counter clockwise to reduce the overall volume level.

BATTERY PROBLEMS	REMEDY
I get no sounds when the engine shifts between the direction states.	The battery may be dead or needs charging. See the Battery Backup section for more information.
After I turn off my transformer, my engine continues to make sounds before quitting with a ding of its bell.	ProtoSounds continues to sound for approximately 10 seconds after power to the track has been shut off.
The sounds distort at low voltages.	The battery is insufficiently charged or dead. Follow the recharging instructions found in the section entitled "Self Recharging Battery Backup System".
A repeating horn blast occurs after the power has been shut down.	The battery is insufficiently charged or dead. Follow the recharging instructions found in the section entitled "Self Recharging Battery Backup System".
RESET PROBLEMS	REMEDY
When I first turn the power on, the engine will not begin to run. I have to turn the throttle off and then on again to get the engine to operate.	This is normal behavior. When power to the track is first turned on, ProtoSounds enters a "RESET" phase at which time the engine undergoes a system check. Power must be interrupted to get the engine into the Forward Phase. See the section entitled "DCRU Reverse Unit Operation" for more information.
Whenever I interrupt the power from RESET to enter Forward, the engine goes back into RESET instead of Forward. I know this occurs because the bell dings twice.	Whenever ProtoSounds enters RESET after power has been off for more than 15 seconds, the microprocessor initiates a system check to determine that everything is in working order. This system check requires 2.2 seconds to complete during which time the engine will play the Diesel startup sounds. We recommend that you don't interrupt the power in RESET until the Diesel startup sounds have completed. This will guarantee that the system check will have been completed since the startup sounds take longer than 2.2 seconds to play. If the problem persists, we recommend that you operate the throttle with a slower movement as you interrupt the power in RESET and enter the Forward Phase
BRAKE SOUND PROBLEMS	REMEDY
When the transformer is throttled down, the sounds won't play.	The brake feature has not been activated. See the section on activating the brake feature for more information. The throttle voltage setting on the transformer is either not starting high enough or ending low enough to trigger the brake sounds. Try increasing the throttle setting to 14 volts or higher before throttling down to 8 volts or less.
The brake sounds continue to play even after the engine stops.	The brake feature sound record lasts for three seconds. With practice you can control how quickly you should stop the engine to keep it in sequence with the sound of the brake's squeaking.
The brake feature was activated in neutral after the engine was running in forward, but the brake sounds would not play when triggered after the engine went back into forward or reverse.	The brake feature will only remain enabled if it is triggered in the first direction state you enter after activating the feature in neutral. You cannot interrupt the power twice to enter another direction state and still have the brake feature active. Therefore, in order to make the brake sound feature operate in forward, you must first activate the feature in the neutral position that occurs after the engine was in the reverse state.
After triggering the brake sound and stopping the engine in neutral, the engine begins making passenger station sound effects.	After you trigger the brake sounds, you cannot stop the engine in neutral and leave the track power on without activating the passenger station sounds. If you don't want to hear the passenger station sounds after entering neutral, turn the power off for three seconds to disable the passenger station sound effects.

PFA PROBLEMS	REMEDY
The PFA feature does not begin even after stopping the engine and hearing the brake sounds.	The power was not turned back on once the engine enter the neutral state thus disabling PFA. The transformer throttle was interrupted too quickly in neutral thus disabling PFA. Leave the throttle on in neutral until after the PFA arrival message plays.
The PFA sound effects occasionally repeat themselves.	ProtoSounds has a built-in random number generator that randomly selects each sound clip to play. Because there are only a total of 8 sound clips available in each PFA event, it is probable that a sound can occasionally be repeated one or more times.
Once in PFA, the engine never goes in reverse.	So that the passenger station sound effects and operation is as realistic as possible, ProtoSounds disables the reverse unit state whenever PFA is enabled. This way the engine never goes into reverse as the operator cycles through the various PFA events.
When the engine enters PFA event 5, the bell automatically comes on.	PFA has a built-in command to turn on the bell when the system enters Event 5. After approximately 15 rings of the bell, it automatically will turn off.
Whenever PFA is enabled, pressing the whistle and bell buttons has no affect	Because PFA must control various effects in each PFA event, the bell and whistle functions are disabled until either the PFA events have been completed, or the engine is shut down for 3 or more seconds.
I can't get PFA to begin when the engine is stopped in the neutral position.	It is possible that PFA was never enabled or has been disabled. Try reactivating the feature by holding down the bell button for three or more seconds.

PROTOSOUND RESET FEATURE CHART

The following chart lists the available features found in your ProtoSound equipped locomotive. The default settings for each feature as well as the operation sequence of the feature are listed in separate columns. You can reset all features to their original factory settings by accessing Feature 18 in RESET and press and hold the transformer whistle button until you hear a soft, warbled bell sound.

RESET #	OPERATION	DEFAULT	CLANKS/CLINKS
6	Engine Volume	Full Volume	1 Clank/5 Clinks
10	Coupler ON/OFF	Coupler ON	2 Clanks/0 Clinks
18	Reset Default Settings		3 Clanks/3 Clinks
20	Remote Bell Button	Bell Button Active	4 Clanks/0 Clinks
23	Cab Chatter	Cab Chatter ON	4 Clanks/3 Clinks
25	Whistle In Neutral	Whistle In Neutral OFF	5 Clanks/0 Clinks
27	Chuff Rate	Full Chuff Range	5 Clanks/2 Clinks
28	Brake/PFA Enabled	Brake/PFA ON	5 Clanks/3 Clinks
40	Lockout Enabled	Lockout OFF	8 Clanks/0 Clinks
45	Squeaking Brakes	Brakes Always ON	9 Clanks/0 Clinks

Exploded Parts View

The chart and diagram on the next several pages should be referenced when requesting replacement parts for your RailKing locomotive and cars. Parts can be ordered directly from MTH Electric Trains, 7020 Columbia Gateway Drive, Columbia, MD 21046-1532

Dash-8 Wide Nose Diesel Engine

Parts

Name	Part #		
1.) Shell (Conrail #6062)	FC-2200017	39.) Truck side (silver)(R front & L rear)	DB-2200004
1.) Shell (BNSF #740)	FC-2200018	40.) Screw (M3 x 6.0mm)(roundhead)	IA-0000016
2.) Horn	FC-2200002	41.) Screw	IA-0000016
3.) Handrail (rear)(black)	FC-2240004	42.) Bracket (speaker)	IH-0000032
4.) Handrail (left)(black)	FC-2220005	43.) Speaker (unison, U4408B01, 8Ω, 0.3W)	BF-4500012
5.) Handrail (right)(black)	FC-2210005	44.) Screw (M2 x 4.0mm)	IA-0000007
6.) Headlight Lens	FA-2230006	45.) Fuel tank (black)	FC-2200019
7.) Handrail (front)(black)	FC-2230004	45.) Fuel tank (silver)	FC-2200020
8.) Windows	FA-2230007	46.) Screw (M3 x 6.0)(roundhead)	IA-0000016
9.) Bulb (18v)(Small globe, bayonet base)	CG-0000002	47.) Screw (M3 x 6.0)(roundhead)	IA-0000016
10.) Light Socket	CH-0000005	48.) Traction tires	DE-0000018
11.) Lock-out Switch (small)	BB-0000009	49.) Screw (M3 x 6.0)(roundhead)	IA-0000016
12.) Screw (2.5 x 4.0mm) (roundhead)	IA-0000023	50.) Pilot (Conrail blue)	DG-2250005
13.) Nut (6.0 x 10.0 x 2.0mm)	IC-0000007	50.) Pilot (BNSF Green)	DG-2250006
14.) Washer (7.0 x 12.0 x .5mm)	ID-0000034	51.) T-bar (4.0mm x 20.0mm)	IG-0000001
15.) Screw (M3 x 6.0mm)(roundhead)	IA-0000016	52.) Proto coupler	DD-4000001
16.) Proto-sound board /volume pot bracket	IH-0000033	53.) Spring (6.5 x 12.0mm)	IE-0000007
17.) Insulator	ID-0000006	54.) Washer (5.0 x 10.0 x 1.0mm)	ID-0000026
18.) Insulator	ID-0000007	55.) E-clip (3.0 x 8.0 x .5mm)	IF-0000002
19.) Screw (M3 x 6.0mm)(roundhead)	IA-0000003	56.) Truck Block (3 axle)	DA-2250001
20.) Screw (M3 x 6.0mm)(roundhead)	IA-0000046	57.) Screw (M3 x 14.0mm)(roundhead w/lock washer)	IA-0000012
21.) Proto-sound bracket	IH-0000034	58.) Nut	IC-0000008
22.) Screw (M3 x 6.0mm)(roundhead)	IA-0000016	59.) Insulator (bottom, flat)	BD-0000041
23.) Volume pot (B10K, SW w/ 20.0mm long wires)	BI-0000017	60.) Pick up (8.0mm roller)(19.5mm long)	BD-0000042
24.) Proto sound (top board)	AE-4500001	61.) Screw (M3 x 6.0mm)(roundhead)	IA-0000016
25.) Proto sound chip	N/A	62.) Number board (#6062)	FG-2200005
26.) Proto sound (bottom board)	AD-4500001	62.) Number board (#740)	FG-2200006
27.) Battery leads (14.5mm long)	BC-0000003		
28.) Battery	BG-4000001		
29.) Rubber Band	BI-4500004		
30.) Motor (RS-365SH)(24.0mm long worm gear)	BE-0000027		
31.) Motor mount	BI-0000018		
32.) Screw (M2.5 x 6.0mm)(roundhead w/lock washer)(yellow zinc)	IA-0000001		

Horn Only Parts

NS = Not shown in exploded view.

Name	Part #
63.) Coupler (mechanical)(44.0mm long)	DD-0000003
64.) Armature plate (37.6mm long)	DD-0000022
NS) Screw (DCRU bracket mounting screw)(4.40 x 4.0 mm)(roundhead)	IA-0000021
NS) Bracket (DCRU)	IH-0000019
NS) Screw (DCRU board mounting screw)(4.40 x 16.0 mm)(roundhead)	IA-0000045
24.) Horn Board	AF-4500004
26.) Reverse unit (DCRU)	AC-0000001

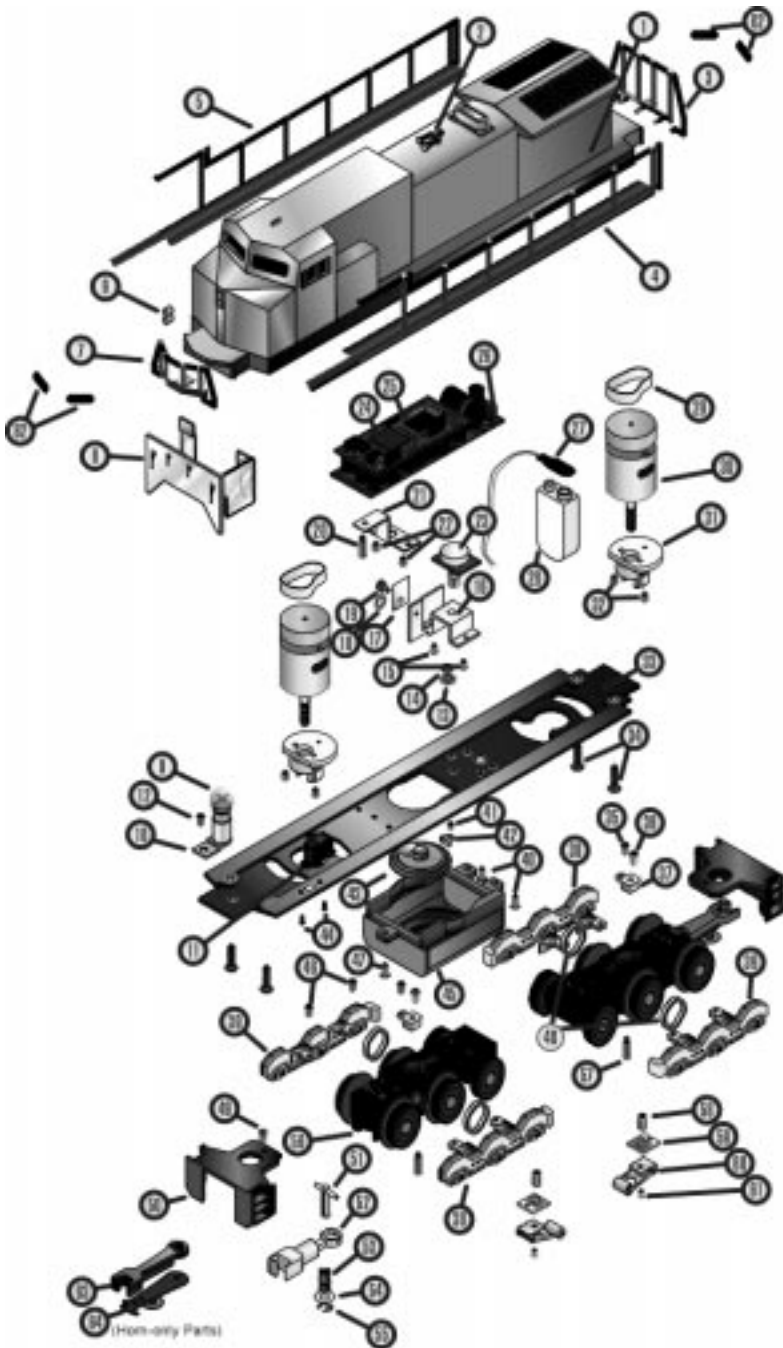

WARNING: When using electrical products, basic safety precautions should be followed including the following:

Read this manual thoroughly before using this device.

This device is not recommended for children under ten years of age without adult supervision.

MTH recommends parents examine the toy transformer periodically for conditions that may result in the risk of fire, electric shock, or injury to persons, such as damage to the primary or output cord, plug blades, housing or other parts, and that, in an event such conditions exist, the transformer should not be used until properly repaired.

This Z-500 Hobby Transformer Power Unit is intended to be used indoors. Do not use if water is present. Serious or fatal injury may result.

Do not use this Z-500 Hobby Transformer Power Unit for other than its intended purpose. This unit was designed to operate with Z-500 Control Unit.

This Z-500 Hobby Transformer Power Unit was designed to operate on 120 volt, 60 Hertz power. Do not connect to any other source of power.

Do not operate the Z-500 Hobby Transformer Power Unit with damaged cord, plug or case.

To avoid the risk of electrical shock, do not disassemble the unit. There are no user serviceable parts inside. If damaged call MTH service for instructions.

CAUTION: Do not operate your layout unattended. Obstructed accessories or stalled trains may overheat resulting in damage to your layout.

If the circuit breaker trips, unplug the power cord from power source (electrical wall outlet), check your layout for any short circuits, reset the circuit breaker, plug the power cord into the power source (electrical wall outlet), and resume operation.

SERVICE AND WARRANTY INFORMATION

HOW TO GET SERVICE UNDER THE TERMS OF THE LIMITED ONE YEAR WARRANTY

For warranty repair, do not return your product to the place of purchase. Instead, follow the instructions below to obtain warranty service as our dealer network is not prepared to service the product under the terms of this warranty.

1. First, write, call or FAX MTH Electric Trains, 7020 Columbia Gateway Drive, Columbia, MD 21046, 410-381-2580 (FAX No. 410-381-6122), stating when it was purchased and what seems to be the problem. You will be given a return authorization number to assure that your merchandise will be properly handled upon its receipt.

2. CAUTION: Make sure the product is packed in its original factory packaging including its foam and plastic wrapping material so as to prevent damage to the merchandise. The shipment must be prepaid and we recommend that it be insured. *A cover letter, including your name, address, daytime phone number, a copy of your sales receipt, a Return Authorization number and a full description of the problem, must be included to facilitate the repairs. Please include the description regardless of whether you discussed the problem with one of our service technicians when contacting MTH for your Return Authorization number.*

3. Please make sure you have followed the instructions carefully before returning any merchandise for service.

LIMITED ONE YEAR WARRANTY

This item is warranted for one year from the date of purchase against defects in material or workmanship. We will repair or replace (at our option) the defective part without charge for parts or labor, if the item is returned to the address below within one year of the original date of purchase. This warranty does not cover items that have been abused or damaged by careless handling, traction tires, pickup rollers or lamps. Transportation costs incurred by the customer are not covered under this warranty.

This warranty gives you specific legal rights and you may have other rights which vary from state to state.

Proto-Sound® is a trademark of MTH Electric Trains. DCRU® is a registered copyright of QS Industries, Inc.