

*RAILKING*  
**READY-TO-RUN™**  
THE COMPLETE SOLUTION

[www.railking.com](http://www.railking.com)

# Christmas 4-6-0 Steam Freight Set

Operation Manual

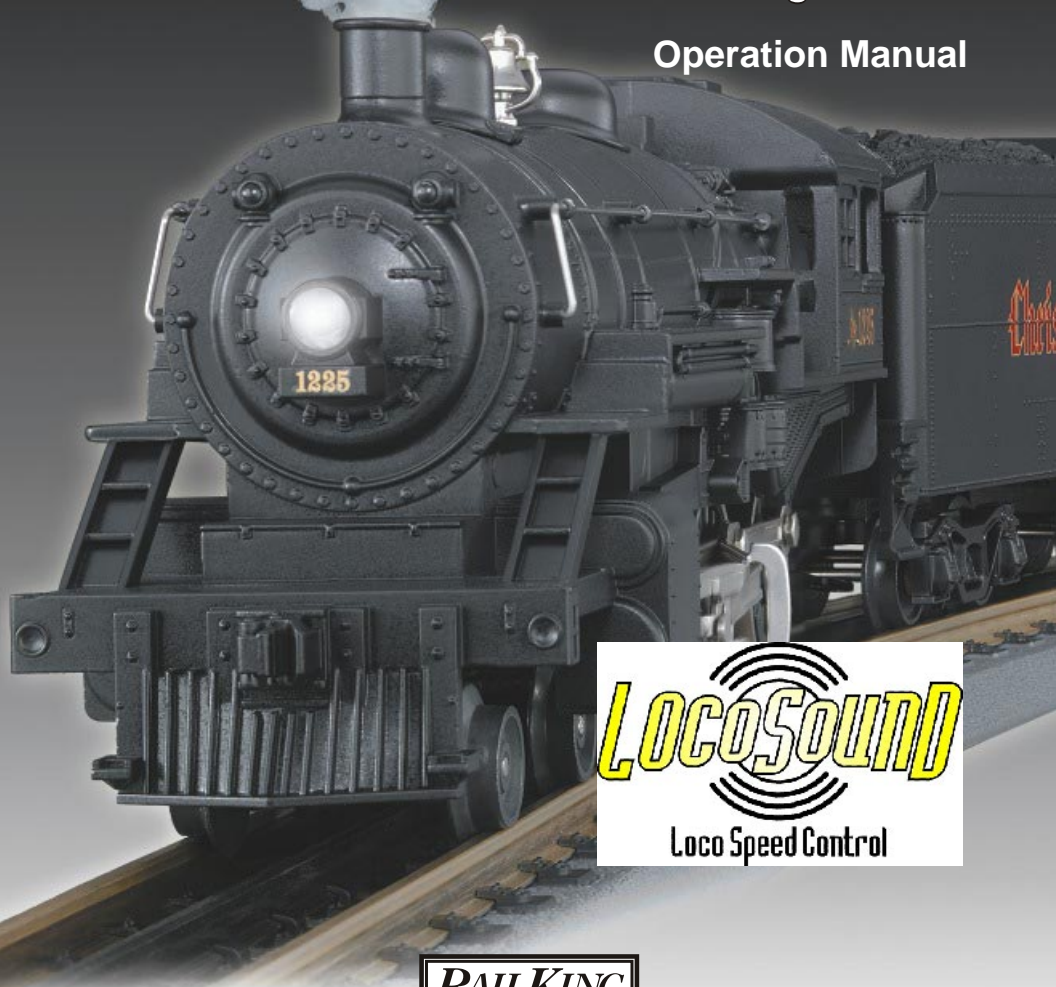

**LOCO SOUND**  
Loco Speed Control

**RAILKING**  
By MTH Electric Trains

Thank you for purchasing this RailKing product.  
**PLEASE READ BEFORE USE AND SAVE**

# Table of Contents

<b>Set Up Checklist</b> .....	<b>3</b>
<b>Getting Started</b> .....	<b>4</b>
Assembling RealTrax .....	4
Connecting the Transformer .....	4
Lubricating the Engine .....	5
Priming the Smoke Unit .....	5
Coupling the Engine and Cars .....	6
Remote Control .....	6
<b>Basic Operation</b> .....	<b>7</b>
Operation Buttons .....	7
Speed Control .....	8
Direction Lock .....	8
Proto-Cast and Proto-Dispatch .....	9
Manual Volume Control .....	10
<b>Maintenance</b> .....	<b>11</b>
Care of Remote Control .....	11
Lubrication and Greasing Instructions .....	11
Cleaning the Wheels, Tires and Track .....	12
Locomotive Traction Tire Replacement .....	12
Smoke Unit Maintenance .....	12
Locomotive Light Bulb Replacement .....	13
Caboose Light Bulb Replacement .....	14
<b>RailWare Interactive CD ROM</b> .....	<b>15</b>
<b>Troubleshooting</b> .....	<b>16</b>
<b>Compatibility</b> .....	<b>17</b>
<b>Transformer Compatibility Chart</b> .....	<b>17</b>
<b>Exploded View Parts</b> .....	<b>18</b>
<b>Service and Warranty Information</b> .....	<b>24</b>

**CAUTION: ELECTRICALLY OPERATED PRODUCT:**

Not recommended for children under 10 years of age. M.T.H. recommends adult supervision with children ages 10 - 16. As with all electric products, precautions should be observed during handling and use to reduce the risk of electric shock.

**WARNING:** When using electrical products, basic safety precautions should be observed, including the following:

Read this manual thoroughly before using this device.

- M.T.H. recommends that all users and persons supervising use examine the hobby transformer and other electronic equipment periodically for conditions that may result in the risk of fire, electric shock, or injury to persons, such as damage to the primary cord, plug blades, housing, output jacks or other parts. In the event such conditions exist, the train set should not be used until properly repaired.
- Do not operate your layout unattended. Obstructed accessories or stalled trains may overheat, resulting in damage to your layout.
- This train set is intended for indoor use. Do not use if water is present. Serious injury or fatality may result.
- Do not operate the hobby transformer with damaged cord, plug, switches, buttons or case.
- The transformer was designed to operate on regular US household current (120 volt, 50-60 Hertz). Do not connect to any other source of power.
- To avoid the risk of electrical shock, do not disassemble the transformer unit. There are no user-serviceable parts inside. If the unit is damaged contact M.T.H. Service for instructions.
- The transformer is equipped with an internal circuit protector. If the circuit protector trips, unplug the power cord from the electrical wall outlet, check your layout for any short circuits. The circuit breaker will reset automatically when the short is removed from the circuit.
- Unplug the transformer from the electrical wall outlet when not in use.
- Do not use this transformer for other than its intended purpose.

**Transformer Ratings:**

Input: 120 VAC, 60 Hz Only; Output: 21VAC, 3.75A78VA

# Set Up Checklist

- Assemble RealTrax®
- Connect the transformer
- Lubricate the engine
- Prime the Smoke Unit
- Place the engine and cars on the track and couple them together
- Position remote lock-on lens
- Apply power to run as described in the Basic Operation section of these instructions.

## Set Includes

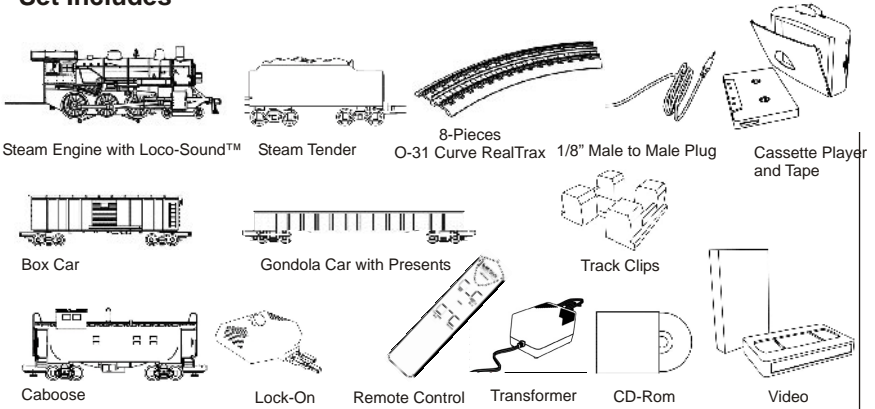

## Tools Needed

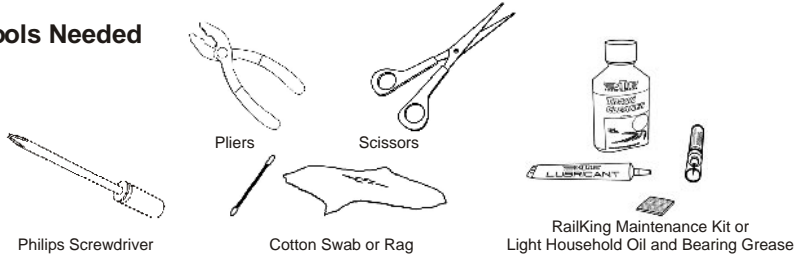

## Optional Equipment



**You can obtain replacement parts and replacement instructions from the M.T.H. Parts Department**

e-mail: [parts@meth-railking.com](mailto:parts@meth-railking.com)

phone: 410-381-2580

mail: 7020 Columbia Gateway Drive, Columbia MD 21046-1532

# Getting Started

## Assembling RealTrax®

The quick connectors and built-in roadbed allow you to set up RealTrax anywhere, including carpeted surfaces.

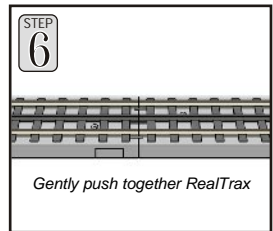
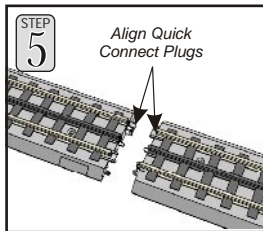
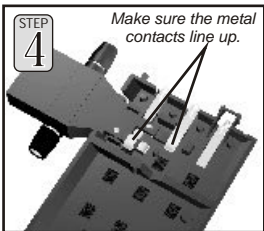
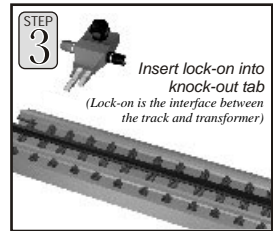
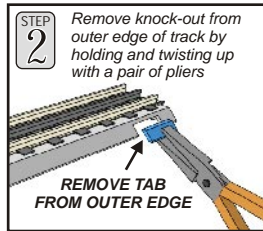
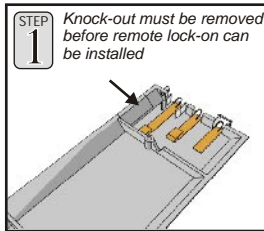

## Connecting Track Clips

If you prefer not to screw your track to the table for a permanent layout, use the enclosed track clips on adjoining curved RealTrax sections to secure them in place.

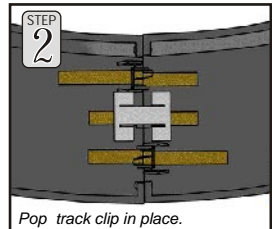
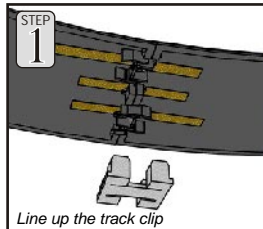

## Connecting the Transformer

The 75-watt power supply included with this set provides an easy-to-use, safe power source for AC-powered trains and accessories.

- Plug the wire from the transformer into the remote lock-on's center port, then plug the transformer into the wall outlet.
- Unplug when not in use.

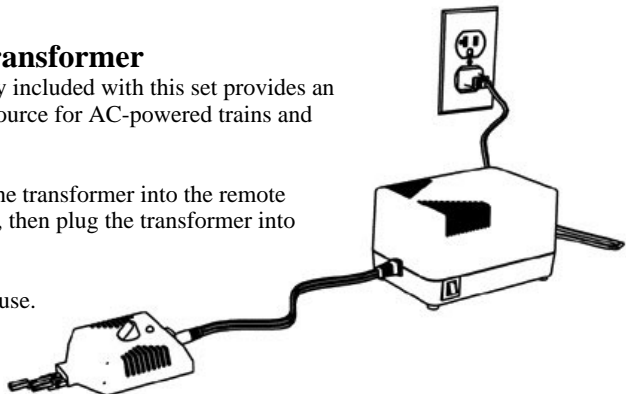

## Lubricating the Engine

Lubricate all exposed moving parts before operating using a multi-purpose, plastic-compatible oil (available with M.T.H.'s Maintenance Kit, sold separately) or a light household oil. Follow the lubrication points.

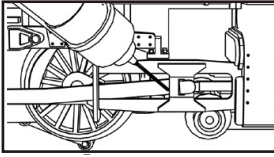

Lubricate Valve Gear

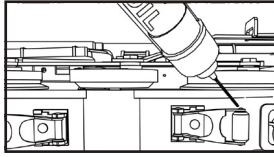

Lubricate Pick-Up Rollers  
(Do Not Oil the Flat Part of Pick-Up Rollers)

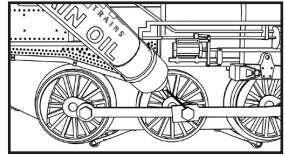

Lubricate Side Rods

## Priming the Smoke Unit

You should prime the smoke unit with smoke fluid before operating. Add 15-20 drops of smoke fluid from the included pipette through the smokestack, then gently blow into the stack to eliminate any air bubbles in the fluid.

If you choose not to prime the unit with fluid, turn the smoke unit switch located under the tender to the OFF position. **Running the engine without a primed smoke unit may cause damage.** See the "ProtoSmoke Unit Operation" section of this book for more information on smoke unit maintenance.

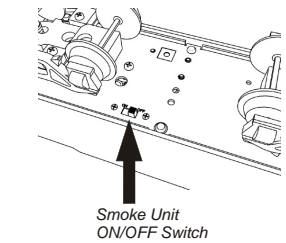
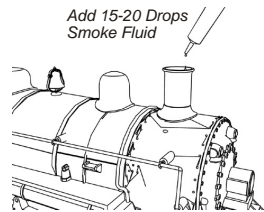

**Running the engine without a primed smoke unit may cause damage**

## Coupling the Engine and Cars

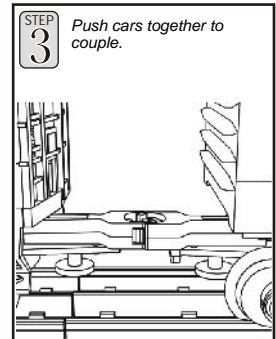
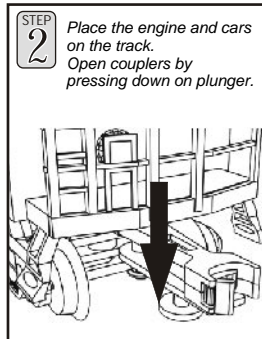
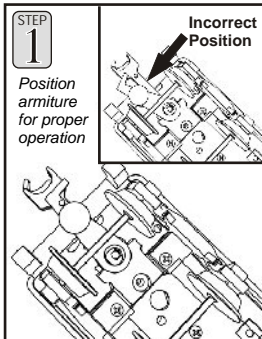

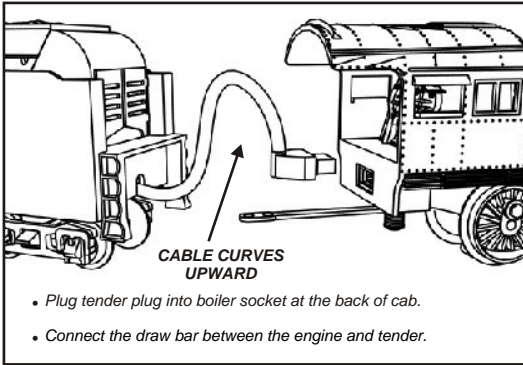

**! DO NOT CONNECT This Engine To A Tender From Another Engine; It May Cause Serious Damage.**

*Look at the bottom of the engine and tender where each will have a color-coded stamp. If they match you may connect those two pieces; if not, don't.*

### Remote Control

The remote and lock-on are designed for use with moderate power supplies such as the one included with this set. It is compatible with virtually any manufacturer's engines.

**STEP 1**

*Remove phillips screw with screwdriver on back of remote.*

**STEP 2**

*Insert two AA batteries (not included) into the remote.*

**STEP 3** *Aim remote control at the rounded side of the lock-on sensor to send track. Lock-on sensor can be rotated to the direction you will most often signal.*

**STEP 4** *Green LED flashing indicates lock-on is receiving signals from remote.*

**STEP 5** *Controls trains from up to 15 feet from the lock-on.*

**Note:** The RailKing<sup>®</sup> Remote Control and Remote Lock-on will not operate engines equipped with pre-1997 versions of Proto-Sound<sup>®</sup> or with Proto-One,<sup>™</sup> Proto-Plus,<sup>™</sup> Proto-Deluxe,<sup>™</sup> aftermarket systems.

# Basic Operation

## Operation Buttons

**Throttle Up** Throttle up the power to your track by pressing the top end of the Throttle Control Rocker Switch firmly for about 5 seconds, until the engine's headlight and lighted cars burn bright. Then put the engine into motion by firmly pressing the Direction button (hold it for approximately 1 second) on your remote once. If the engine does not begin to move as soon as you firmly press the Direction button, you may not have sent enough voltage to the track to make the train move. Press the throttle up for a few more seconds until the train begins to move.

To increase or decrease track voltage, and therefore train speed, press the throttle control rocker switch. Pressing the top end of the throttle will increase voltage and speed. Pressing the bottom end of the throttle will decrease voltage and speed.

The engine will maintain the speed you set after you release the throttle until you press it again to change the voltage and speed.

**Bell** - To sound the bell, firmly press and release the Bell button. To turn the bell off, press and release the Bell button again. The bell will continue to ring from the time you turn it on until you press and release the button again to turn it off.

**Emergency Stop** Press the Emergency Stop button and all trains on the track controlled by the remote will stop until you reapply voltage. This is an easy way to shut down your trains at the end of a session or to stop suddenly if the train's path becomes obstructed.

**CAUTION:** Do not mix old and new batteries. Do not mix alkaline, standard (carbon-zinc), or rechargeable (nickel-cadmium) batteries.

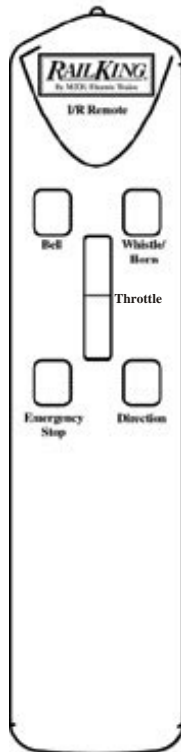

**Horn/Whistle** - To sound the whistle, firmly press the Horn/Whistle button. The whistle will sound for as long as you continue to depress the button. It will stop when you release the button.

**Direction** Your train is programmed to start in neutral. The train will always cycle neutral-forward-neutral-reverse with each press and release of the direction button. The engine is programmed to restart in neutral each time the track voltage is turned off for 25 seconds or more.

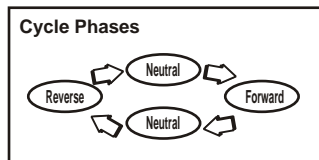

## Speed Control

M.T.H. engines equipped with Loco-Sound have speed control capabilities that allow the engine to maintain a constant speed up and down grades and around curves, much like an automobile cruise control. You can add or drop cars on the run, and the engine will maintain the speed you set.

While the engine is programmed to start with the speed control feature activated, you can opt to turn it off. This means the engine's speed will fall as it labors up a hill and increase as it travels downward. It is also affected by the addition or releasing of cars while on the run. To maintain a constant speed when speed control is turned off, you need to adjust track voltage yourself.

**To turn speed control on and off**, put the engine in neutral, then quickly tap the transformer's Whistle button one time then quickly tap the Bell button two times, allowing approximately ½ second to lapse between each quick button press. Repeat the 1 whistle, 2 bells code to return it to the other condition. **You will want to do this during the initial neutral upon start-up if you ever couple this engine to another engine that is not equipped with speed control to avoid damaging the motors in either engine.** Each time you shut down the engine completely, it will automatically turn speed control on.

Timing Chart				
Press Whistle Short & Firm	½ Sec. Pause	Press Bell Short & Firm	½ Sec. Pause	Press Bell Short & Firm
Total Time Lapse: 1 ½ Seconds				



Place Engine into Neutral



=

Speed Control Repeat to Return to Normal Condition

## Direction Lock

You can lock your engine into a direction (forward, neutral, or reverse) so that it will not change directions. To do this, put the engine into the direction you want or into neutral, to lock it into neutral, run it at a very slow crawl (as slowly as it will move without halting), and quickly but firmly tap the Whistle button once followed by three quick taps of the Bell button, allowing approximately ½ second to lapse between each quick button press. The engine will not change direction (including going into neutral) until you repeat the 1 whistle, 3 bells code to return the engine to its normal condition, even if the engine is kept without power for extended periods of time.

Place Engine into Desired Direction



=

Direction Lock Repeat to Return to Normal Condition



## Proto-Cast and Proto-Dispatch:

When used with the remote lock-on included in this set, Loco-Sound equipped engines gain Proto-Cast™ and Proto-Dispatch™ features.

### Proto-Cast:



Allows you to play audio recordings through your engine's speakers. You must supply the audio source (a small portable CD/tape player is sufficient) and a male-to-male mini cable (1/8" plug, like that used for the headset with a portable CD/tape player) to connect your audio source to the remote lock-on.

### To use Proto-Cast

- Plug the mini-cable *first* into your audio source (usually into the headphone jack)
- Plug Cable into the "Audio" port on the right side of the remote lock-on.
- Adjust the volume. If engine sounds keep breaking through the recorded sounds, increase the volume on the audio source.

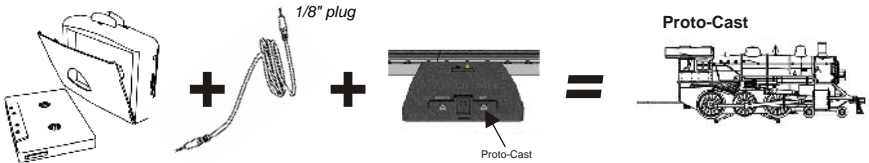

### Proto-Dispatch:



This feature allows you to broadcast your own voice through your engine's speakers. You must supply the microphone and a mini cable (1/8" plug, like that used for the headset with a portable CD/tape player) to connect your microphone to the remote lock-on.

### To use Proto-Dispatch

- Mini-cable attached to the microphone must be an 1/8" plug.
- Plug the "Mic" into the proto-dispatch port on the left side of the remote lock-on and speak into the microphone.



When these features are in use, the locomotive's own sounds (engine sounds and bells, whistles, and horns) will be muted so that only the sounds you broadcast will be heard. Because these two features are voice activated, there will be a several second delay after you stop speaking into the microphone or turn off the audio source before the engine sounds resume. To stop using the feature and return to normal operation, unplug the cable from the lock-on jack.

If using parallel tracks with multiple Loco-Sound equipped engines, Proto-Cast and Proto-Dispatch transmissions from one track may be picked up by the other nearby engines.

If you experience popping and interference when using Proto-Cast or Proto-Dispatch, try cleaning the track with denatured alcohol as described in the "Cleaning the Wheels, Tires and Track" section of this booklet.

**NOTE: M.T.H. does not recommend using Proto-Cast and Proto-Dispatch at the same time.**

### Manual Volume Control

To adjust the volume of all sounds made by this engine, turn the master volume control knob located under the tender clockwise to increase the volume and counter-clockwise to decrease the volume.

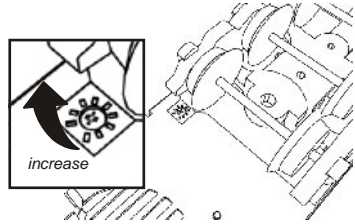

# Maintenance

## Care of the Remote Control

To ensure trouble-free operation:

- Do not drop the remote. It can damage the delicate electronics inside.
- Remove batteries before storing for extended periods.
- Any attempt by anyone other than an authorized M.T.H. repair person to open and repair the handheld transmitter or lock-on may result in damage and the loss of warranty protection.
- If your train responds inconsistently, replace old batteries with fresh ones. Do not mix old and new batteries.

## Lubrication Instructions

The engine should be oiled and greased in order to run properly.

Regularly lubricate all side rods and linkage components and pickup rollers to prevent squeaking. Use light household oil, such as that found in M.T.H.'s maintenance kit. Do not over oil. Use only a drop or two on each pivot point.

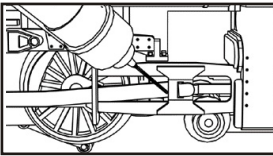

Lubricate Valve Gear

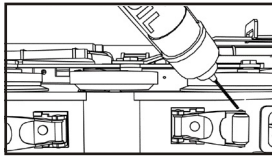

Lubricate Pick-Up Rollers  
**(Do Not Oil the Flat Part of Pick-Up Rollers)**

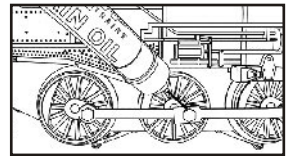

Lubricate Side Rods

## Greasing Instructions

The locomotive's internal gearing was greased at the factory. Grease engine every 50 hours of use or one year. Use a lithium based grease and follow the greasing instructions.

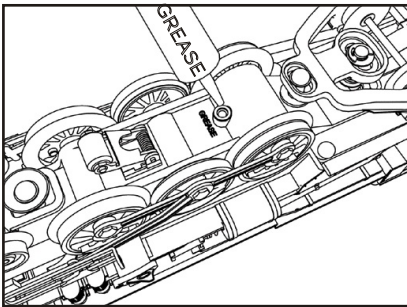

- Remove the screw from the chassis to open the grease port.
- Insert the grease tube tip into the port and squeeze the tube once or twice to add grease to the gearbox.
- Wipe off any excess grease and replace the phillips screw securely.

## Cleaning the Wheels, Tires and Track

Periodically check the locomotive wheels and pickups for dirt and buildup, which can cause poor electrical contact and traction and prematurely wear out the neoprene traction tires. Wheels and tires can be cleaned using denatured (not rubbing) alcohol applied with a cotton swab.



To clean the track, use RailKing Track Cleaning Fluid and a clean rag or denatured (not rubbing) alcohol. Unplug the transformer and wipe the rails of the track, turning the rag frequently to ensure that you are using clean cloth on the rails. Because the manufacturing process leaves a coating on RealTrax center rail, you should clean the rails after the first 30 minutes of use (you may notice an electrical smell during initial use as the coating wears off; this is normal). Thereafter, keep an eye on the track and clean it when it gets dirty to ensure good electrical contact and to lengthen the life of the tires.

## Traction Tire Replacement Instructions

Your locomotive is equipped with two neoprene rubber traction tires on the rear set of flanged drivers. While these tires are extremely durable, you may need to replace them at some point.

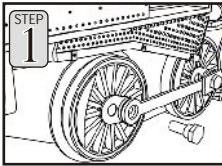

- Remove the side rods (the rods that connect each drive wheel to the other) from the wheels in order to slip the new tire over the grooved drive wheel. These bolts can be loosened with a 5mm nutdriver.
- Clean the groove using a cotton swab and denatured alcohol.

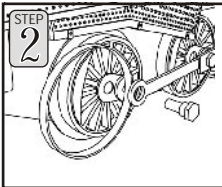

- Make sure the old tire has been completely removed from the groove in the drive wheel, using a razor blade or small flathead screwdriver to pry away any remains.
- Clean the groove using a cotton swab and denatured alcohol.
- Slip the new tire onto the wheel. You may find it useful to use two small flathead screwdrivers to stretch the tire over the wheel.
- If you twist the tire while stretching it over the wheel, you will need to remove and reinstall the tire. Otherwise your engine will wobble while operating.
- Make sure the tire is fully seated inside the groove. Use a razor blade to trim away any excess tire that doesn't seat itself inside the groove properly.

## ProtoSmoke<sup>®</sup> Unit Operation

This steam locomotive contains a smoke unit that outputs smoke through the smokestack on the boiler of the engine. The smoke unit is essentially a small heating element and wick that soaks up and then heats a mineral oil-based fluid that emits a harmless smoke. The smoke is then forced out of the stack by a small electric fan.

With a few easy maintenance steps, you should enjoy trouble-free smoke unit operation for years.

- When preparing to run this engine, add 15-20 drops of smoke fluid through the smokestack. We recommend M.T.H. ProtoSmoke, Seuthe, LGB, or LVTS fluids (a

small pipette of ProtoSmoke fluid is included). Do not overfill the unit or the fluid may leak out and coat the interior engine components.

- If you choose not to add the fluid (or have already added the fluid but choose to run smoke-free), turn off the smoke unit switch located under the tender body. **Failure either to add fluid to the unit or to turn it off may damage the smoke unit heating element and/or wicking material.**

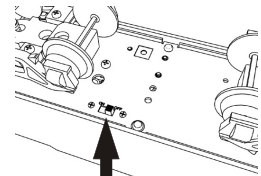
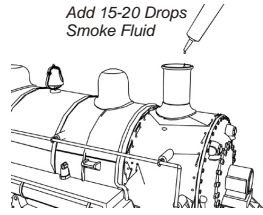

Smoke Unit ON/OFF Switch

**Warning:** Running the engine without a primed smoke unit may cause damage

- When the smoke output while running the engine begins to diminish, add another 10-15 drops of smoke fluid or turn the smoke unit off.
- When storing the unit for long periods of time, you may want to add about 15 drops of fluid to prevent the wick from drying out.
- After removing the engine from storage, add another 25 drops of fluid, letting the wick soak up the fluid for 15 minutes prior to operation.

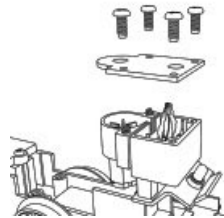

Smoke Unit Cover

If you experience poor or no smoke output when the smoke unit is on and has fluid, check the wick to see if it has become hard, blackened, and unabsorbent around the heating element. Remove the boiler as shown below. Remove the smoke unit inspection cover from the locomotive's body (see right). After removing the chassis and inspection cover screws, lift the inspection plate away and inspect the wick. If it is darkly discolored and hard, it should be replaced. When priming new wick add 40 drops.



Wick in Poor Condition



Wick in Good Condition

## Locomotive Light Bulb Replacement

To replace the light bulb in the locomotive, follow the boiler removal instructions below.

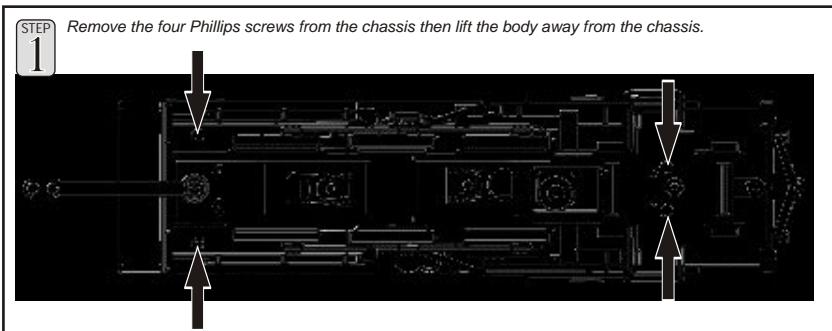

STEP  
1

Once the locomotive boiler has been removed from its chassis, locate the bulb bracket as seen in the illustration on the right and rotate the headlight bulb counter-clockwise to remove.

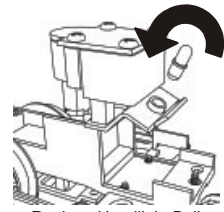

## Caboose Light Bulb Replacement

To replace the interior light bulbs follow these instructions and see the diagrams below.

STEP  
1

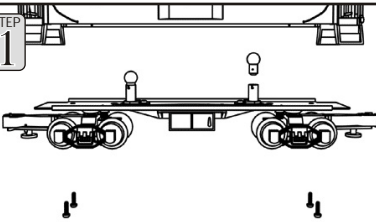

Remove the four (4) screws located under the caboose's trucks.

STEP  
2

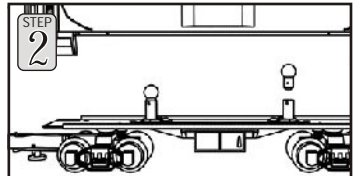

Lower the chassis from the shell, taking care not to pull the wires out.

STEP  
3

Replace a Bayonet Bulb by turning and pushing up, pulling the bulb from its socket.

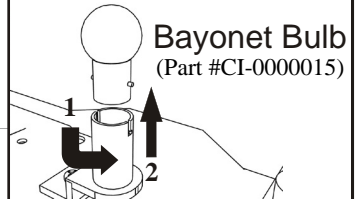
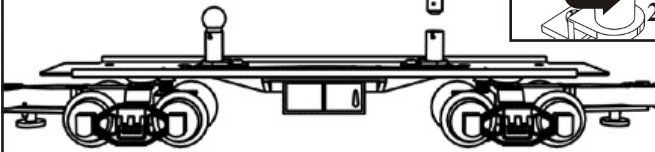

# Quick-Start Video

The included VHS Quick-Start video demonstrates the start-up and basic operation of this set as well as other information about model railroading. You may find it helpful to view the video before operating this set.

# RailWare Interactive CD ROM

M.T.H. provides a free RailWare CD ROM in each Ready-To-Run set. It is full of helpful information on M.T.H. product history, track planning software, a dealer finder, and information and video clips on Loco-Sound and Proto-Sound 2.0. Follow the directions below to use the CD ROM.

Minimum System Requirements: Pentium 100, 16MB RAM, Windows 95 or later, CD ROM drive, Sound Card, display properties set to greater than 256 colors. The CD will not work on a Mac OS unless you run VirtualPC®.

# Running RR-Track Software

You may run the RR-Track software directly off of the CD ROM or you may install the software to your hard drive.

1. On the Desktop, click on the icon that says My Computer.
2. Find your CD ROM drive.
3. With the M.T.H. CD ROM in the drive, double click on the icon for the CD ROM drive.
4. Find the folder on the CD ROM entitled INSTALLATION.
5. Choose the folder inside entitled RRTRAXSETUP.
6. Run the file in that folder called SETUP.EXE and follow the directions it provides.

The program may ask you for a registration code. If it does type in "M.T.H." and it will run.

Additional track libraries can be obtained directly from RR-Track. See their website for more information [www.rtrack.com](http://www.rtrack.com).

# Installing Adobe Acrobat Software

To read some of the electronic documents included on the CD ROM, you will need to install the Adobe Acrobat Reader® if it is not already on your computer. To install the software:

1. On the Desktop, click on the icon that says My Computer.
2. Find your CD ROM drive.
3. With the MTH CD ROM in the drive, double click on the icon for the CD ROM drive.
4. Find the folder on the CD ROM entitled INSTALLATION.
5. Choose the folder inside entitled ACROBAT READER.

\*If you are running Windows 95, 98 or NT choose the folder 32 BIT. Run the file AR32E301.EXE and follow the directions it provides.

If you have problems you cannot resolve by using these directions, contact [custserv@mth-railking.com](mailto:custserv@mth-railking.com) or call 410-381-2580 for further help.

# Troubleshooting Loco-Sound™ Problems

Although Loco-Sound has been designed and engineered for ease of use, you may have some questions during initial operation. The following table should answer most questions. If your problem cannot be resolved with this table, contact M.T.H. for assistance (e-mail: [service@mth-railking.com](mailto:service@mth-railking.com); telephone: 410-381-2580; fax: 410-423-0009; mail: 7020 Columbia Gateway Drive, Columbia MD 21046-1532).

<b>Starting Up</b>	<b>Remedy</b>
When I first turn the power on, the engine will not begin to run.	This is normal behavior. To prevent accidental high-speed start-ups, Loco-Sound is programmed to start up in neutral anytime track power has been turned off for several seconds. See the "Basic Operation" section for more details.
The engine will not start after I press the Direction button.	You may not be sending enough power to the track to power the engine. Press the throttle up for a few more seconds to increase track power.
<b>Whistle</b>	<b>Remedy</b>
I can't get the whistle to blow when I press the whistle button.	You may be pressing the button too quickly. Try pressing the whistle button more slowly, taking approximately one full second to fully depress the button.
<b>Bell</b>	<b>Remedy</b>
I can't get the bell to ring when I press the bell button.	You may be pressing the button too quickly. Try pressing the bell button more slowly, taking approximately one full second to fully depress the button.
<b>Lock-out</b>	<b>Remedy</b>
I can't get the engine to run after I power up the transformer. It sits still with the engine sounds running.	The engine may be locked into the neutral position. Follow the procedure in the "Lock into a Direction" section to <u>unlock the engine's direction</u> .
The engine won't lock into forward, neutral, or reverse.	Engine speed must be below 10 scale mph (approx. 10 volts or less in conventional mode).
<b>Volume</b>	<b>Remedy</b>
The sounds seem distorted, especially when the Horn or bell is activated.	Loco-Sound volume is set too high. Turn the volume control knob on the bottom of the chassis counter-clockwise to <u>reduce the volume</u> .
No sound.	Volume is set too low, adjust volume control knob on the bottom of the chassis clockwise to increase the volume or check connector to speaker.
<b>Proto-Cast and -Dispatch</b>	<b>Remedy</b>
When I try to play music or my voice through my engine's speakers, there is popping and interference.	Clean the track with denatured alcohol, as described in the "Cleaning the Wheels, Tires, and Track" section of this book.
My Proto-Cast sounds play too quietly or unclearly.	Unplug the cable between the audio source and the remote lock-on. Re-plug it into the audio source first, then into the lock-on, pushing firmly to make sure it is fully installed.
When I try to play Proto-Cast, the engine's sounds keep breaking in on my recording.	Your recording may be playing too quietly to trigger the engine to stop playing its own sound set. Turn up the volume of the audio source you are using.
When I run two Loco-Sound engines on tracks near each other, the Proto-Cast and Dispatch sounds play from both engines, not just from the one connected to the audio source or microphone.	This is normal behavior. Because Loco-Sound uses radio waves to transmit the sound to the engine, other Loco-Sound engines in the same range will also pick up the sound. Try moving one of the sets.



# Compatibility

While this Ready-To-Run set is equipped with everything you need to operate it, the design allows flexibility. The train will operate on any traditional O-31 or larger O Gauge track system, including the RealTrax<sup>®</sup> included with this set or traditional tubular track. It is also compatible with most standard AC transformers, including the hobby transformer packaged with your set.

## Transformer Compatibility and Wiring Chart

Note that many of the operational commands described in these instructions require a bell button, so if you are using a transformer other than the one included in this set and your transformer does not have its own bell button, you should consider adding one to get the full benefit of the system.

Transformer Model	Center Rail	Outside Rail	Min/Max. Voltage	Power Rating	Transformer Type
MTH Z-500	Red Terminal	Black Terminal	0-18v	50-Watt	Electronic
MTH Z-750	Red Terminal	Black Terminal	0-21v	75-Watt	Electronic
MTH Z-4000	Red Terminal	Black Terminal	0-22v	390-Watt	Electronic
Lionel 1032	U	A	5-16v	90-Watt	Standard
Lionel 1032M	U	A	5-16v	90-Watt	Standard
Lionel 1033	U	A	5-16v	90-Watt	Standard
Lionel 1043	U	A	5-16v	90-Watt	Standard
Lionel 1043M	U	A	5-16v	90-Watt	Standard
Lionel 1044	U	A	5-16v	90-Watt	Standard
Lionel 1053	U	A	8-17v	60-Watt	Standard
Lionel 1063	U	A	8-17v	60-Watt	Standard
All-Trol	Left Terminal	Right Terminal	0-24v	300-Watt	Electronic
Dallee Hostler	Left Terminal	Right Terminal			Electronic
Lionel LW	A	U	8-18v	75-Watt	Standard
Lionel KW	A or B	U	6-20v	190-Watt	Standard
Lionel MW	Outside Track Terminal	Inside Track Terminal	5-16v	50V.A.	Electronic
Lionel RS-1	Red Terminal	Black Terminal	0-18v	50V.A.	Electronic
Lionel RW	U	A	9-19v	110-Watt	Standard
Lionel SW	U	A	Unknown	130-Watt	Standard
Lionel TW	U	A	8-18v	175-Watt	Standard
Lionel ZW	A,B,C or D	U	8-20v	275-Watt	Standard
Lionel Post-War Celebration Series ZW	A,B,C or D	Common	0-20v	135/190 Watt	Electronic

## 4-6-0 Steam Locomotive Engine Parts

Name and Number	Part #
1.) Shell ( black )( boiler ) ( Christmas )( # 1225 )	FB-1200264
2.) Bell ( nickel )	FB-1200101
3.) Handrail ( nickel )( boiler ) ( right )( 150.0mm long )( bends down 13.4mm )	FB-1210042
4.) Handrail ( nickel )( boiler ) ( left )( 150.0mm long )( bends down 13.4mm )	FB-1220049
5.) Stanchion ( black ) ( plastic )( 3.0mm long )	FB-1200242
6.) Lens ( green )( marker light )	FA-1230021
7.) Lens ( clear )( headlight )	FA-1230022
8.) Wire nut ( yellow )	BI-4500003
9.) Smoke unit ( Proto-Sound 2.0® & Loco-Sound® )	AA-0000029
10.) Bulb ( clear )( headlight ) ( 6v )( small globe )( screw base )	CA-0000038
11.) Bracket ( black ) ( headlight / smoke unit )( metal )( angled )	IH-0000174
12.) Screw ( 4/40x6.0mm )( roundhead )	IA-0000003
13.) Insulator ( black ) ( top )( square )( pick-up )	BD-0000026
14.) Screw ( nickel ) ( M3x6.0mm )( roundhead )	IA-0000015
15.) Screw ( yellow Zinc ) ( M2.5x6.0mm )( roundhead w/ lock washer )	IA-0000089
16.) Motor mount ( black )	BI-0000034
17.) Screw ( 6/32x8.0mm )( roundhead )	IA-0000050
18.) Motor ( RS-365SH ) ( 8.0x29.0mm worm gear )( 14.5mm long threads ) ( 9.0x30.0mm white flywheel w/ black stripes ) ( w/ black plastic tach board mounting strap )	BE-0000079
19.) Ferrite bead ( grey ) ( 4.6x9.7x9.4mm )( barrel shape )	AI-0000030
20.) Tach board ( has small resister on backside of tach board )	AG-0000048
21.) Screw ( 6/32x6.0mm )( roundhead )	IA-0000027
22.) PC board ( green ) ( 10 pin female plug )( 20.5x24.2mm ) ( w/ out 2-IN4004 diodes )	AG-0000045
23.) Draw bar ( black ) ( 67.5mm long )	FB-1200079

24.) Spring ( nickel ) ( 6.5x10.0mm )( w/ 0.6mm thick wire )	IE-0000061
25.) Screw ( 6/32x6.0mm )( washer head )	IA-0000214
26.) Traction tire	DE-0000023
27.) Side rod ( nickel ) ( 94.0mm long )( 3 bolt holes )	EC-1250026
28.) Drive rod ( nickel ) ( 74.5mm long )( 7.0mm step )	EC-1250027
29.) Crosshead ( nickel ) ( 38.8mm long )	EC-1250016
30.) Bolt ( nickel )( M3x9.4mm ) ( 4.0x2.5mm shoulder )( 5.0mm hex head )	IA-0000253
31.) Nut ( nickel ) ( 2.5x5.0x10.0mm )	IC-0000005
32.) Insulator ( black ) ( pick-up )( bottom )( plastic )	BD-0000001
33.) Pick-up ( 8.0x11.0mm roller )( 28.0mm long )	BD-0000048
34.) Crosshead guide assembly ( nickel )( 2 crosshead guides connected together )	EA-1200016
35.) Spacer ( black )( cupped ) ( 3.5x15.0x2.5mm )( metal )	ID-0000014
36.) Truck ( black ) ( lead )( 2 axle )( boiler )	DA-1230015
37.) Bracket ( black )( lead truck )	IH-0000076
38.) Screw ( 4/40x4.0mm )( roundhead )	IA-0000021
39.) E-clip ( 2.5x6.0x0.5mm )	IF-0000004
40.) Bracket ( black )( lead truck ) ( 38.9mm long )( 4.5mm step )	IH-0000175
41.) Pin ( black ) ( 3.0x14.8mm )( 6.3mm rounded head ) ( 1 e-clip groove 0.5mm out from end )	IG-0000037
42.) Drive block ( black )( 3 axle )	DF-1200040
43.) Capacitor ( blue )( .01 uF ) ( 16.0x2.0mm )( 2 wire leads )	AI-0000031
44.) Washer ( black ) ( 3.0x6.0x0.4mm )( fiber )	ID-0000040
45.) Screw ( 6/32x4.0mm )( roundhead )	IA-0000060
NS.) Wire harness ( female 10 pin PC board )	BC-1200120

# 4-6-0 Steam Locomotive Engine Parts

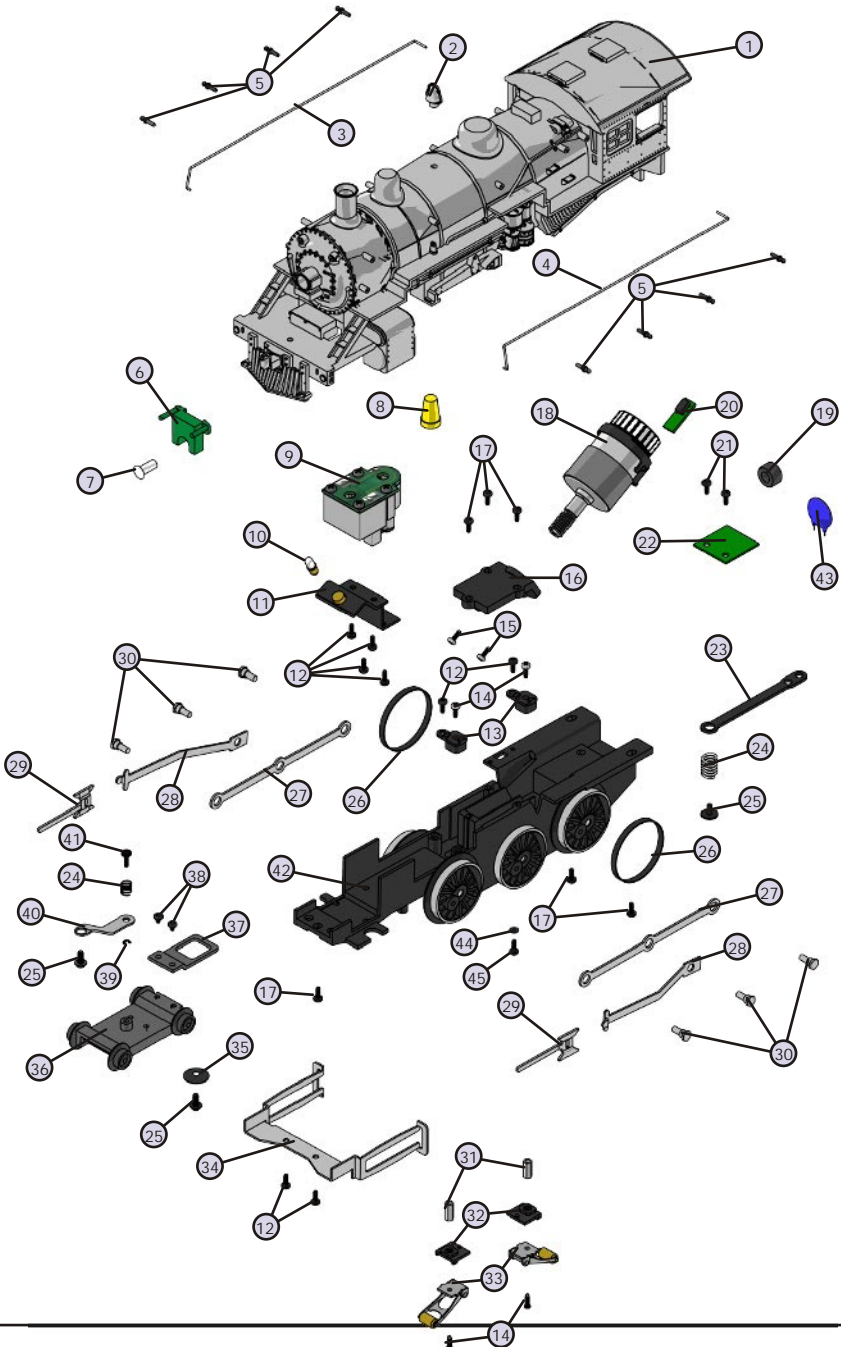

## 4-6-0 Steam Tender Parts

Name and Number	Part #
1.) Shell ( black ) ( tender )( Christmas Express )( plastic )	GA-1200106
2.) Screw ( M3x6.0mm )( roundhead )	IA-0000016
3.) Speaker cone ( black ) ( 44.0x48.3x23.0mm )( 2 screw hole tabs )( plastic )	BF-0000016
4.) Speaker ( Cuistack )( GF0501, 8 ohms, 0.25 watt )	BF-0000015
5.) Gasket ( black ) ( speaker ring )( 43.8x49.8x3.0mm )( foam )	IB-0000009
6.) Wire harness ( black male 10 pin plug )	BC-1200121
7.) Chassis ( black )( tender ) ( has holes for battery charger jack )	GB-1200052
8.) Screw ( 4/40x6.0mm )( roundhead )	IA-0000003
9.) Insulator washer ( white ) ( 6.0x4.0x2.5mm )( plastic )	ID-0000033
10.) Insulator ( clear ) ( 13.0x19.0x0.1mm )( single hole )	ID-0000024
11.) Board ( Loco-Sound™ )	AE-0000003
12.) Wire nut ( yellow )	BI-4500003
13.) Bracket ( Aluminum ) ( for Loco-Sound™ board )	IH-0000266
14.) Screw ( M3x4.0mm )( roundhead )	IA-0000010
15.) Screw ( M3x8.0mm )( roundhead )	IA-0000035
16.) Volume pot ( small )( blue )	BI-0000040
17.) Spacer ( black ) ( 3.0x6.0x4.0mm )( plastic )	ID-0000071
18.) Switch ( small )	BB-0000009
19.) Screw ( M2x4.0mm )( roundhead )	IA-0000058
20.) T-bar ( black ) ( 4.0x20.0mm )( plastic )	IG-0000001
21.) Coupler ( black ) ( mechanical )( 51.5mm long )	DD-0000039
22.) Armature ( black ) ( 45.0mm long )	DD-0000040
23.) Spring ( 6.5x11.0mm )( w/ 0.4mm thick wire )	IE-0000007
24.) Washer ( black )( plastic ) ( 4.6x8.6x2.0mm )( inside 7.0x1.0mm )( cup shaped )	ID-0000060
25.) E-clip ( 3.0x8.0x0.5mm )	IF-0000002
26.) Screw ( M3x16.0mm )( washer head )( self-drilling threads )	IA-0000025
27.) Screw ( 6/32x6.0mm )( washer head )	IA-0000214
28.) Truck ( black ) ( 2 axle )( leading/trailing )( tender )	DA-1250007
NS.) Wire harness ( black male 12 pin plug )	BC-1200122

# 4-6-0 Steam Tender Parts

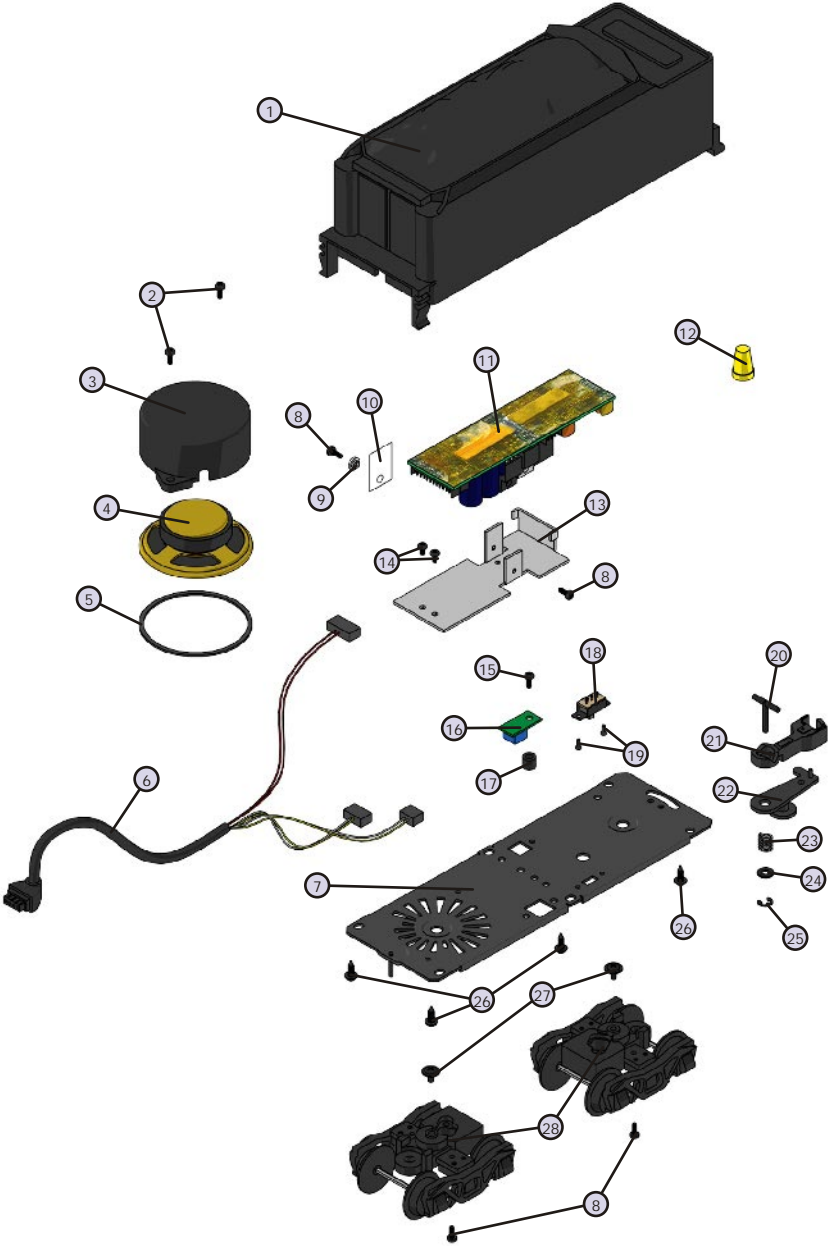

# Service & Warranty Information

## How to Get Service Under the Terms of the Limited One-Year Warranty

For warranty repair, follow the instructions below to obtain warranty service.

First, e-mail, write, call or fax an Authorized M.T.H. Service Center in your area or M.T.H. Electric Trains to obtain Repair Authorization. You can find the list of Authorized Service Centers on the M.T.H. website, [www.mth-railking.com](http://www.mth-railking.com). Authorized Service Centers are required only to make warranty repairs on items sold from that store; all other repairs may or may not be done at the store's own discretion. Otherwise, contact M.T.H. (fill out the Service Contact form in the Service Section of [www.mth-railking.com](http://www.mth-railking.com); send US mail to the address listed below; tel: 410-381-2580; fax: 410-423-0009), stating when the item was purchased and describing the problem. If you contact M.T.H., you will be given a return authorization number to assure that your merchandise will be properly handled upon its receipt.

**CAUTION:** Make sure the product is packed in its original factory packaging including its foam and plastic wrapping material so as to prevent damage to the merchandise. The shipment must be prepaid and we recommend that it be insured. *A cover letter including your name, address, daytime phone number, e-mail address (if available), Return Authorization number, a copy of your sales receipt and a full description of the problem must be included to facilitate the repairs. Please include the description regardless of whether you discussed the problem with a service technician when contacting the Service Center or M.T.H. for your Return Authorization.*

Please make sure you have followed the instructions carefully before returning any merchandise for service.

## Limited One-Year Warranty

All M.T.H. products purchased from an Authorized M.T.H. Train Merchant are covered by this warranty.

See our website at [www.mth-railking.com](http://www.mth-railking.com) or call 1-888-640-3700 to identify an Authorized M.T.H. Train Merchant near you.

M.T.H. products are warranted for one year from the date of purchase against defects in material or workmanship, excluding wear items such as light bulbs, pick-up rollers, batteries, smoke unit wicks, and traction tires. We will repair or replace (at our option) the defective part without charge for the parts or labor, if the item is returned to an Authorized M.T.H. Service Center or M.T.H. Electric Trains within one year of the original date of purchase. This warranty does not cover damages caused by improper care, handling, or use. Transportation costs incurred by the customer are not covered under this warranty.

Items sent for repair must be accompanied by a return authorization number, a description of the problem, and a **copy of the original sales receipt from an Authorized M.T.H. Train Merchant**, which gives the date of purchase. If you are sending the item to M.T.H., fill out the Service Contact form in the Service Section of [www.mth-railking.com](http://www.mth-railking.com); send US mail to the address listed below; call 410-381-2580, or fax 410-423-0009 to obtain a return authorization number. If you are sending this product to an Authorized Service Center, contact that Center for their return authorization.

This warranty gives you specific legal rights, and you may have other rights that vary from state to state.

Service Department





## AUTHORIZED SERVICE CENTER

7020 Columbia Gateway Dr. - Columbia, MD 21046

Information: 410-381-2580 Fax: 410-381-6122

[www.mth-railking.com](http://www.mth-railking.com)

## PARTICIPATING RETAILER LIST

ALABAMA  
SOUTHERLAND STATION  
HUNTSVILLE  
256-533-4720  
[railway@bellsouth.net](mailto:railway@bellsouth.net)

ARIZONA  
ARIZONA TRAIN DEPOT  
MESA  
480-833-9486  
[sales@arizonatraindepot.com](mailto:sales@arizonatraindepot.com)  
[www.arizonatraindepot.com/](http://www.arizonatraindepot.com/)

CALIFORNIA  
DOLLHOUSES, TRAINS & MORE  
NOVATO  
415-883-0388  
[kbecker@cmc.net](mailto:kbecker@cmc.net)

TIN PLATE JUNCTION  
OAKLAND  
510-444-4780  
[TOYTRAINS@email.msn.com](mailto:TOYTRAINS@email.msn.com)

COLORADO  
MIZELL TRAINS Inc  
WESTMINSTER  
303-429-4811  
[mizelltrains@cs.com](mailto:mizelltrains@cs.com)  
[www.mizelltrains.com](http://www.mizelltrains.com)

CONNECTICUT  
SHELTON RAILROAD SYSTEMS  
SHELTON  
203-924-8761  
[adriani@clearlight.com](mailto:adriani@clearlight.com)  
NEW ENGLAND HOBBY SUPPLY  
MANCHESTER  
860-646-0610  
[bobbell@nehobby.com](mailto:bobbell@nehobby.com)

DELAWARE  
K R R B MODEL TRAINS INC.  
NEWARK  
302-292-2779  
[info@krrb.com](mailto:info@krrb.com)  
[www.krrb.com](http://www.krrb.com)

FLORIDA  
DEPOT HOBBY SHOP  
LAKE WORTH  
561-585-1982  
[jimmyt1982@aol.com](mailto:jimmyt1982@aol.com)  
[www.depothobbies.com](http://www.depothobbies.com)

COLONIAL PHOTO & HOBBY  
ORLANDO  
407-841-1485  
[trains@colonialphotoandhobby.com](mailto:trains@colonialphotoandhobby.com)

WARRICK CUSTOM HOBBIES  
PLANTATION  
954-370-0708  
[info@warrickcustomhobbies.com](mailto:info@warrickcustomhobbies.com)  
[www.warrickcustomhobbies.com](http://www.warrickcustomhobbies.com)

FRANK'S TRAINS & HOBBIES INC.  
OLDSMAR  
813-855-1041  
[FTH@allhobbies.com](mailto:FTH@allhobbies.com)  
[www.allhobbies.com](http://www.allhobbies.com)

READY TO ROLL  
MIAMI  
305-688-8868  
[rtrtrains@aol.com](mailto:rtrtrains@aol.com)  
[www.readytorolltrains.com](http://www.readytorolltrains.com)

ILLINOIS  
BIKE & CHOO CHOO CONNECTION  
SCHAUMBURG  
847-882-7728  
[trainconnection@aol.com](mailto:trainconnection@aol.com)

INDIANA  
Y. O. R. K. TRAINS  
MUNSTER  
219-838-9999  
[yorktrains@aol.com](mailto:yorktrains@aol.com)

SAMUELSON'S TRAIN SHOP  
VALPARAISO  
219-462-2708

LOUISIANA  
AMERICA'S TRAIN YARD  
BATON ROUGE  
225-926-5592

MAINE  
WHEELS, WINGS & THINGS  
LUDLOW  
207-532-6277  
[irc44@javanet.com](mailto:irc44@javanet.com)

MARYLAND  
ENGINE HOUSE HOBBIES  
GAITHERSBURG  
301-590-0816  
[luciecerise@aol.com](mailto:luciecerise@aol.com)

J & B TRAINS  
HAGERSTOWN  
240-420-4930

HOBBYTOWN U S A  
FREDERICK  
301-694-7395

PURKEY'S TOY TRAINS  
SYKESVILLE  
410-549-6061  
[wiley@oldmainline.com](mailto:wiley@oldmainline.com)

THE TRAIN ROOM  
HAGERSTOWN  
301-745-6681

MASSACHUSETTS  
NORTHEAST TRAINS  
PEABODY  
978-532-1615  
[www.netrains.com](http://www.netrains.com)

MICHIGAN  
BRASSEUR ELECTRIC TRAINS INC.  
SAGINAW  
517-793-4753  
[bob@traindoctor.com](mailto:bob@traindoctor.com)  
[www.traindoctor.com](http://www.traindoctor.com)



MISSOURI  
SWITCH STAND  
SAINT LOUIS  
314-781-4458  
r41877@earthlink.com

MARK TWAIN HOBBY CENTER  
ST. CHARLES  
636-946-2816  
webmaster@hobby1.com  
www.hobby1.com

NEW HAMPSHIRE  
TREASURED TOYS  
SALEM  
603-898-7224  
ttoys@treasured-toys.com  
www.treasured-toys.com

RAILROAD SPECIALTIES  
HUDSON  
603-882-5566  
crew@electric-trains.com  
www.electric-trains.com

NEW JERSEY  
TRAINS & THINGS  
TRENTON  
609-883-8790  
trainsanthings@aol.com

GRAND CENTRAL STATION  
KEARNY  
201-955-6200  
228gene@gateway.com

HOBBYMASTERS, INC  
RED BANK  
732-842-6020  
hobbymasters@hobbymasters.com

HOLLY BEACH TRAIN DEPOT  
WILDWOOD  
609-522-2379  
larry@pro-usa.net

COAST TRAINS AND COLLECTIBLES  
WALL  
732-556-9005  
coasttrain@aol.com  
www.coasttrains.com

J & B TRAINS, INC.  
MAPLE SHADE  
856-414-0092  
BASE1130@aol.com

HOBBY SHOP  
MATAWAN  
732-583-0505  
hobbyshopnj.com

ATLANTIC RAILS  
HAMMONTON  
609-567-8490  
bobcap@pics.com  
www.atlanticrails.com

COUNTRY AND STUFF  
ANDOVER  
973-786-7086  
stuff@crystal.palace.net

RIDGEFIELD HOBBY  
RIDGEFIELD  
201-943-2636

COLUMBUS TRAIN STATION  
COLUMBUS  
609-518-1800

NEW YORK  
AURORA RAILS & HOBBIES  
EAST AURORA  
716-652-5718  
rk82141@aol.com

AMERICANA STORE  
TIVOLI  
845-757-4246  
mthdepot@valstar.net

NASSAU HOBBY CENTER, INC.  
FREEPORT  
516-378-9594  
Charlienassau@aol.com

KROSS HARDWARE  
WEST BABYLON  
631-669-3069  
t989@aol.com

CITY DEPOT, INC.  
NEW HAMPTON  
845-374-3010  
citydepot@frontiernet.net  
www.citydepot.com

NORTH CAROLINA  
DRY BRIDGE STATION  
MOUNT AIRY  
336-786-9811  
mikek@drybridgestation.com  
www.drybridgestation.com

THE FREIGHT YARD  
SMITHFIELD  
919-934-6229  
disbissette@aol.com

TRAINS LTD.  
CHARLOTTE  
704-566-9070  
modelrrs@bellsouth.net  
www.trainstld.com

THE ROUNDHOUSE & BACKSHOP  
CARY  
919-465-0810

OHIO  
DIXIE UNION STATION  
MASON  
513-459-0460  
rockylane@core.net  
www.dixieunionstation.com

RICK'S TOY TRAINS  
TOLEDO  
419-478-0171

T & K HOBBY SHOP  
BRIDGEPORT  
740-633-6607  
salea@tkhobbies.com  
www.tkhobbies.com

TRAINS-N- THINGS  
CANTON  
330-499-1666  
trains@sssnet.com

PARMA HOBBY  
CLEVELAND  
216-741-6440  
info@parmahobby.com

GLEN'S TRAIN SHOP  
AKRON  
330-253-6527

E & S TRAINS  
AKRON  
330-745-0785

GRAND PACIFIC JUNCTION  
OLMSTEAD FALLS  
440-235-4777  
gpjmrr@juno.com  
HUDSON TOY, TRAIN & HOBBY  
HUDSON  
330-653-2997  
ejpickens@aol.com

DAVIS ELECTRONICS  
MILFORD  
513-831-6425  
davisstrains@fuse.net  
www.davisstrains.com

SANDY'S HOBBY'S & COLLECTIBLES  
ELYRIA  
440-365-9999  
sandyshobb@aol.com

ERIE RAILWAY DEPOT  
TROY  
937-440-9972  
orvile@gte.net

CLEARVIEW TRAIN & HOBBY  
LORAIN  
440-277-4488  
klogar@erienet.net  
www.clearviewtrainandhobby.com

PENNSYLVANIA  
FAIRCHANCE PHARMACY  
FAIRCHANCE  
724-564-7817  
mthdealer@aol.com  
www.hhs.net/fairchance

THE STATION  
NEW CUMBERLAND  
717-774-7096  
station@paonline.com  
BUSSINGER TRAINS  
AMBLER  
215-628-2366  
choochoos@icdc.com  
www.icdc.com/~btrains

CHARLEROI SWEEPER CENTER  
CHARLEROI  
724-483-3397

AMERICAN HOBBY CENTER  
ALIIQUIPPA  
724-378-3930  
american@icubed.com

CRANBERRY HOBBY DEPOT  
CRANBERRY TWP  
724-776-3640  
JAdams6113@aol.com

ALLENTOWN TOY TRAIN SERVICE  
ALLENTOWN  
610-821-0740

ON THE RIGHT TRACK  
ALTOONA  
814-942-4345

JIM'S TRAIN SHOP  
HOMER CITY  
724-479-2026  
sudsy@stargate.net

YE OLDE TRAIN & CHRISTMAS  
SHOPPE  
BOYERTOWN  
610-369-0755  
www.yeoldetrain.com

TOBY TYLER'S HOBBY CENTER  
PITTSBURGH  
412-653-5030  
tobytyler111@cs.com

BUSTLETON TRAIN SHOP  
PHILADELPHIA  
215-698-7266

CHESTNUT TOYBOX  
PHILADELPHIA  
215-545-0455  
chestnuttoy@earthlink.net

THE CABOOSE  
LEHIGHTON  
570-386-5352  
www.thecaboosehobbies.com  
victen@ptd.net

SOUTH CAROLINA  
EMERALD TRAIN & HOBBY  
GREENWOOD  
864-223-2247

TENNESSEE  
MODEL RAILROAD & HOBBY SHOP  
MEMPHIS  
901-384-6500  
mrhs99@earthlink.net  
www.modelrailroadandhobby.com

TEXAS  
HOBBY TIME  
AMARILLO  
806.352.9660  
don.l.harris.@hobby-time.com

VIRGINIA  
TRAIN DEPOT  
MANASSAS  
703-335-2216

NORGE STATION  
WILLIAMSBURG  
757-564-7623  
norgetrains@cs.com

NUTBUSH EXPRESS  
VICTORIA  
804-696-1902  
thenutbushexp@meckcom.net

TOY TRAIN CENTER  
RICHMOND  
804-288-4475

T S G HOBBIES  
WARRENTON  
540-347-9212  
tripi@mnsinc.com  
www.mnsinc.com/tripi/tsg.htm

CHESTERFIELD HOBBIES  
MIDLOTHIAN  
804-379-9091  
chsthobb@erols.com  
www.chesterfieldhobbies.com

DAVIS HOBBY SUPPLIES  
PORTSMOUTH  
757-397-1983  
ralph@davishobby.com  
www.davishobby.com

LOCUST GROVE TRAINS  
LOCUST GROVE  
540-854-8955  
lgtrains@aol.com  
www.locustgrovetrains.com

WEST VIRGINIA  
PATRICK'S TRAINS  
WHEELING  
304-232-0714  
trains@patstrains.com  
www.patstrains.com

WISCONSIN  
SOMMERFELD'S TRAINS  
BUTLER  
262-783-7797  
questions@sommerfelds.com  
www.sommerfelds.com

G B T V & TRAINS  
GREEN BAY  
920-496-9697  
rrtycoon@netnet.net

GRAMPA'S TRAIN SHOP  
RICE LAKE  
715-234-2996  
grampastrains@yahoocom

THE TRAIN STORE  
WAUKESHA  
262-650-6675

HOBBY OUTLET  
FOND DU LAC  
920-924-3770  
hobby\_outlet@hotmail.com

#### CANADA

ONTARIO  
CREDIT VALLEY RAILWAY COMPANY  
STREETSVILLE  
905-826-1306  
CVRCO@globalserve.net  
www.cvrco.com

TOY TRAIN WORKSHOP  
CUMBERLAND  
613-833-3125  
info@toytrainworkshop.com  
www.toytrainworkshop.com

THE TRAIN ROOM  
FERGUS  
519-787-3280