

www.lionelcorporation.com

No. 260 & 263 Steam Freight/Passenger Set

Operation Manual (3V PS2)



FYS



PSA

PLEASE READ BEFORE USE AND SAVE

Table of Contents

Set Up Checklist	3
Getting Started	4
Assembling RealTrax	4
Connecting the Transformer	4
Lubricating the Engine	5
Priming the Smoke Unit	5
Coupling the Engine and Cars	5
Checking the Battery	6
Basic Operation	7
Operation Buttons	7
Manual Volume Control	7
Proto-Sound® 2.0 Operation	8
Activating Proto-Sound® 2.0 Conventional Mode Features (FYS)/(PSA)	8
Tips on Using FYS/PSA	9
Proto-Coupler™ Operation	9
Speed Control	10
Lock into a Direction	10
Reset to Factory Defaults	11
Automatic Sounds	11
Maintenance	12
Lubrication and Greasing Instructions	12
Cleaning the Wheels, Tires and Track	13
Traction Tire Replacement	14
ProtoSmoke™ Unit Operation	14
Locomotive Light Bulb Replacement	15
Caboose Car Light Bulb Replacement	16
Self-Charging Battery Back-Up	17
RailWare Interactive DVD	19
Troubleshooting	20
Compatibility	22
Transformer Compatibility Chart	22
Additional Features with DCS Remote Control System	23
Service and Warranty Information	24

CAUTION: ELECTRICALLY OPERATED PRODUCT:

Recommended for Ages 14 and up. Not recommended for children under 14 years of age without adult supervision. As with all electric products, precautions should be observed during handling and use to prevent electric shock.

WARNING: When using electrical products, basic safety precautions should be followed including the following:

- Read this manual thoroughly before using this device.
- This device is not recommended for children under ten years of age without adult supervision.
- M.T.H.® recommends parents examine the toy transformer periodically for conditions that may result in the risk of fire, electric shock, or injury to persons, such as damage to the primary or output cord, plug blades, housing, screw terminals or other parts, and that, in an event such conditions exist, the transformer should not be used until properly repaired.
- This Z-1000™ Hobby Transformer Power Unit is intended to be used indoors. Do not use if water is present. Serious or fatal injury may result.
- Do not use this Z-1000™ Hobby Transformer Power Unit for other than its intended purpose. This unit was designed to operate with Z-Controller™ Control Unit.
- This Z-1000™ Hobby Transformer Power Unit was designed to operate on 120 volt, 60 Hertz power. Do not connect to any other source of power.
- Do not operate the Z-1000™ Hobby Transformer Power Unit with damaged cord, plug or case.
- To avoid the risk of electrical shock, do not disassemble the unit. There are no user serviceable parts inside. If damaged call M.T.H.® service for instructions.
- **CAUTION:** Do not operate your layout unattended. Obstructed accessories or stalled trains may overheat resulting in damage to your layout.
- If the circuit breaker trips, unplug the power cord from power source (electrical wall outlet), check your layout track and accessories for any short circuits, reset the circuit breaker, plug the power cord into the power source (electrical wall outlet), and resume operation.
- Unplug the Z-1000™ Hobby Transformer Power Unit from power source (electrical wall outlet) when not in use.

Transformer Ratings:

Input: 120 VAC, 60 Hz Only; Output: Z-1000: 14VAC 80W or 18VAC 100W

This product may be protected by one or more of the following patents: 6,019,289; 6,280,278; 6,281,606; 6,291,263; 6,457,681; 6,491,263; 6,604,641; 6,619,594; 6,624,537; 6,655,640.

Set Up Checklist

- Assemble RealTrax®
- Connect the transformer
- Lubricate the engine
- Priming the Smoke Unit
- Place the engine and cars on the track and couple them together
- Check to see whether the battery needs to be charged for full sound effects
- Apply power to run as described in the Basic Operation section of these instructions.

Set Includes

- Steam Locomotive and Tender
- 3 Cars

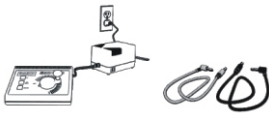
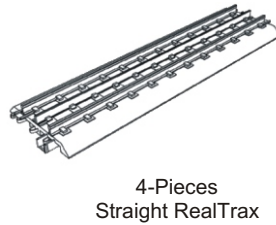

Transformer and Controller
with wire harness

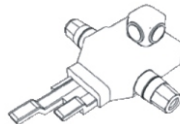

Lighted Lock-On

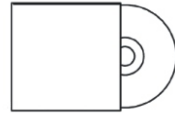

DVD

Tools Needed



Battery Charger (Optional)

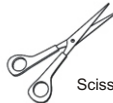

Scissors



Philips Screwdriver



Cotton Swab or Rag



RailKing Maintenance Kit or
Light Household Oil and Bearing Grease

You can obtain replacement parts and replacement instructions from the M.T.H. Parts Department (Order online: www.mth-railking.com, e-mail: parts@mth-railking.com, Fax: 410-423-0009, Phone: 410-381-2500, Mail: 7020 Columbia Gateway Drive, Columbia MD 21046-1532)

Getting Started

Assembling RealTrax[®]

The quick connectors and built-in roadbed allow you to set up RealTrax anywhere, including carpeted surfaces.

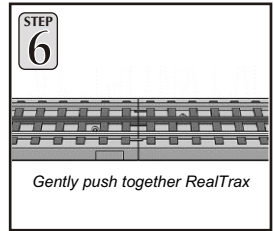
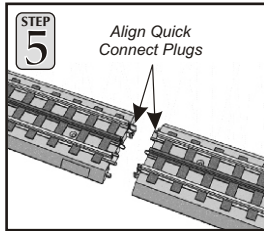
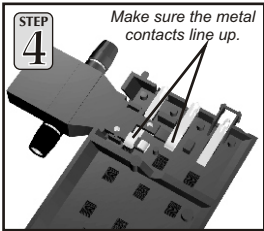
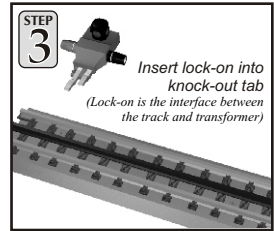
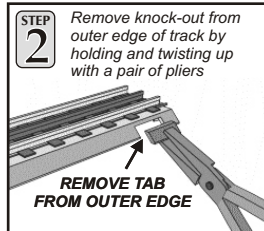
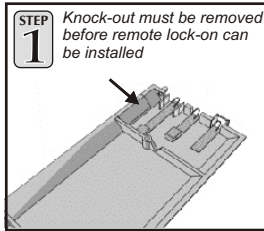

Connecting the Transformer

The transformer included with this set provides an easy-to-use, safe power source for AC-powered trains and accessories.

To complete the connection between the track and the transformer, simply plug in the color-coded wire harness that was included in your set and plug the transformer into your wall outlet.

- Plug the wire from the transformer into the Z-Controller's center port.
- Connect the Wires from the Z-Controller to the Lighted Lock-On, being sure that the wires are connected from red-to-red and black-to-black.
- Unplug when not in use.

Also functions as a binding post.

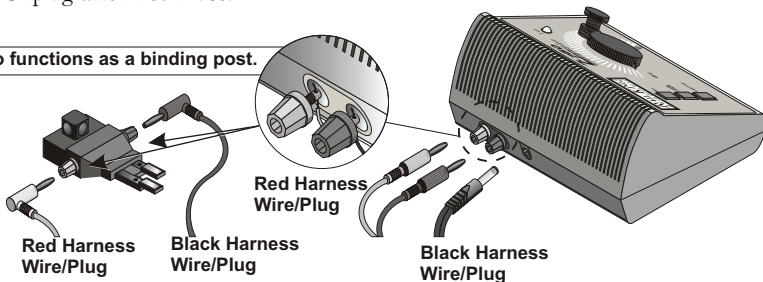

Lubricating the Engine

Lubricate all exposed moving parts before operating using a multi-purpose, plastic-compatible oil (available with M.T.H.'s Maintenance Kit, sold separately) or a light household oil. Follow the lubrication points.

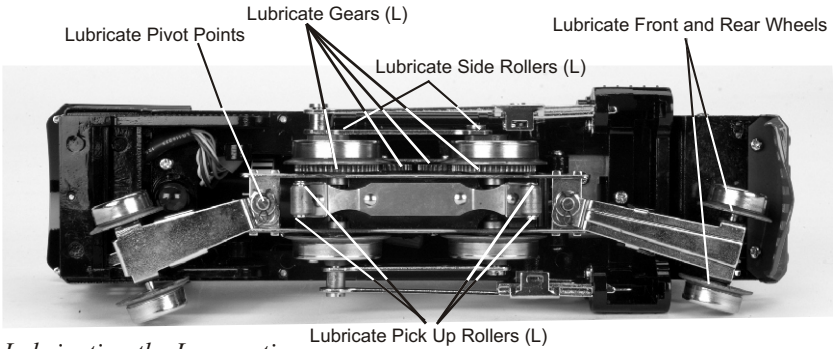

Lubricating the Locomotive

Priming the Smoke Unit

You should prime the smoke unit with smoke fluid before operating. Add 15-20 drops of smoke fluid from the included pipette through the smokestack, then gently blow into the stack to eliminate any air bubbles in the fluid.

If you choose not to prime the unit with fluid, turn the smoke unit control located under the tender to the OFF position. (Full Counter Clockwise Position) **Running the engine without a primed smoke unit may cause damage.** See the "ProtoSmoke Unit Operation" section of this book for more information on smoke unit maintenance.

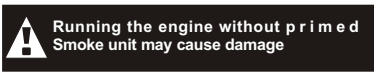

Your No. 260 or 263 Locomotive will be paired with one of the following styles of tender. Please reference the picture for your locomotive.

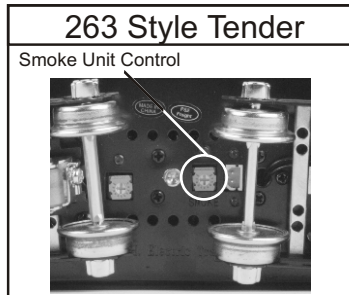
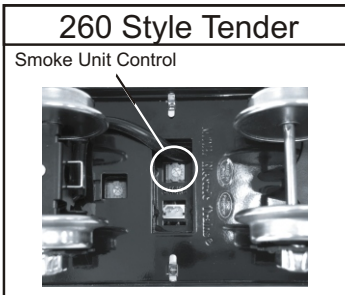

Coupling the Engine and Cars

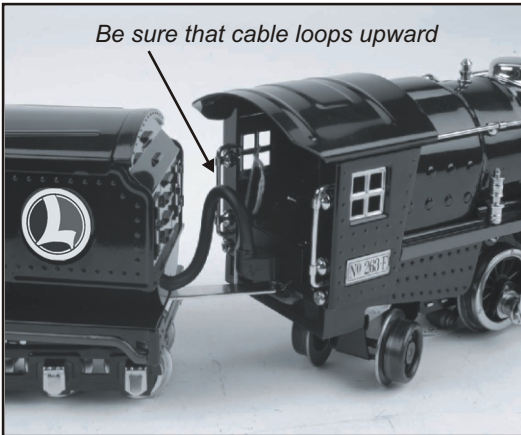
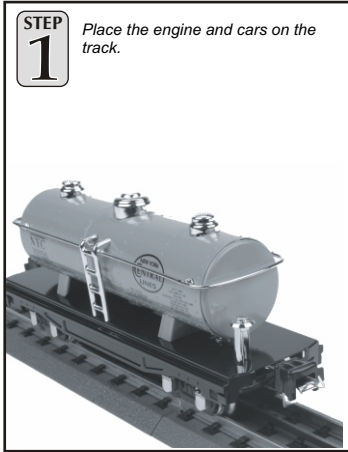

DO NOT CONNECT
This Engine To A
Tender From
Another Engine; It May
Cause Serious Damage.

Look at the bottom of the engine and tender where each will have a color-coded stamp. If they match you may connect those two pieces; if not, don't.

Checking the Battery

You may find, if your set was built several months before you set it up, that the rechargeable battery has run down and needs to be charged before operating. If you notice that the sounds are garbled, test and charge the engine as described in the "Self-Charging Battery Back-Up" on page 16.

Basic Operation

The Throttle knob controls how fast your train will travel.

- Turn the throttle knob up 1/2-way, until the engine and caboose lights shine bright.
- Put the engine into motion by pressing the Direction button on your transformer once. (hold it for approximately 1 second)

If the engine does not begin to move as soon as you firmly press the Direction button, you may not have sent enough voltage to the track to make the train move. Turn the throttle up a bit higher until the train begins to move.

Operation Buttons

Throttle To increase or decrease track voltage, and therefore train speed, turn the throttle control knob. Turning it clockwise will increase voltage and speed, while turning it counterclockwise will decrease voltage and speed. The engine will maintain the speed you set after you release the throttle until you turn it again to change the voltage and speed.

Horn/Whistle - To sound the whistle, firmly press the Horn/Whistle button. The horn will sound for as long as you continue to depress the button. It will stop when you release the button.

Bell - To sound the bell, firmly press the bell button. The bell sound will continue until the bell button is firmly pressed a second time.

Direction Your train is programmed to start in neutral. The train will always cycle neutral-forward-neutral-reverse with each press and release of the direction button. The engine is programmed to restart in neutral each time the track voltage is turned off for 25 seconds or more.

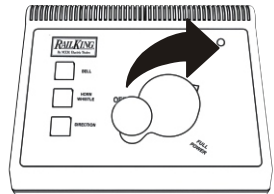

Manual Volume Control

To adjust the volume of all sounds made by this engine, turn the manual volume control (shown below) clockwise to increase the volume and counterclockwise to decrease the volume.

Your No. 260 or 263 Locomotive will be paired with one of the following styles of tender. Please reference the picture for your locomotive.

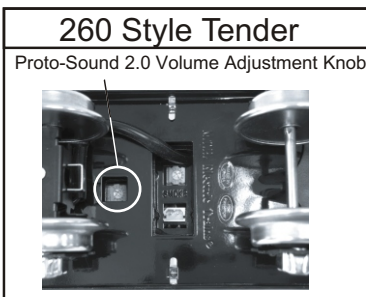

Proto-Sound® 2.0 Operating Instructions

This manual contains the operating instructions for Proto-Sound® 2.0 in conventional mode only. Instructions for accessing DCS command mode features accompany the DCS Remote Control System equipment.

Activating Proto-Sound® 2.0 Conventional Mode Features:

Proto-Sound® 2.0 features are activated by sequences of Bell and Whistle button pushes described below. Please read the full descriptions of each feature before using it. To use these buttons to activate features rather than to blow the whistle or ring the bell, you should tap the buttons very quickly with a ½-second pause between button presses. You may need to practice your timing to make this work smoothly.

Timing Chart				
Press Whistle Short & Firm	½ Sec. Pause	Press Bell Short & Firm	½ Sec. Pause	Press Bell Short & Firm
Total Time Lapse: 1 ½ Seconds				

Feature to Be Activated	Button Code:
Freight Yard or Passenger Station Sounds	1 Bell, 2 Whistles
Fire the Rear Coupler	1 Bell, 3 Whistles
Fire the Front Coupler	1 Bell, 4 Whistles
Speed Control On/Off	1 Whistle, 2 Bells (from Neutral only)
Lock into a Direction	1 Whistle, 3 Bells
Reset to Factory Defaults	1 Whistle, 5 Bells (from Neutral only)

Freight Yard Sounds (FYS) or Passenger Station Announcements (PSA):

Your engine is equipped with a sound package of either freight yard or passenger station sounds that you can play. **Each sequence described below will play as long as it is left on, randomly generating sounds, but be sure to allow approximately 30 seconds between the button pushes described below to allow the FYS/PSA sufficient time to run through each sequence.**

- To cue the sound system to play the FYS/PSA, quickly but firmly tap the Bell button once followed by 2 quick taps of the Whistle button while the engine is moving. Tap the buttons quickly but allow approximately ½ second between each press.
- Press the Direction button once to stop the engine. This will trigger the first sequence of FYS/PSA. The reverse unit is temporarily disabled so that the train will not move as you use the Direction button to trigger the sounds, and Proto-Sound 2.0 has disabled operator control over the Whistle and Bell buttons until the full FYS/PSA sequence is complete.
- After waiting about 30 seconds for that sequence to run, press the Direction button again to trigger the second sequence of FYS/PSA.
- After about 30 seconds, press the Direction button again to trigger the third FYS/PSA sequence.
- Again, after allowing about 30 seconds for that sequence to run, press the Direction button one more time to trigger the fourth and final FYS/PSA sequence.

The FYS/PSA will continue, and within a few seconds, the engine will start and move out on its own at the current throttle setting, in the same direction it was traveling when you began the sequence. Once the bell turns off, the operator regains control of the transformer's Bell and Whistle buttons and can ring the bell or blow the whistle as usual.

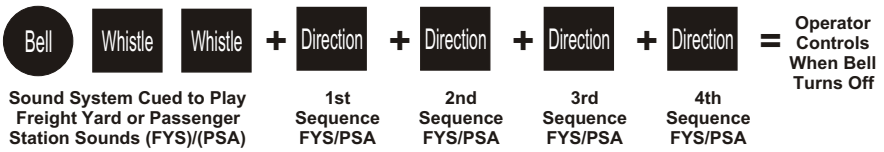

Tips on Using FYS/PSA

- You can terminate FYS/PSA at any time by turning off power to the track for 15 seconds.
- You do not have to be in Forward to use FYS/PSA. At the conclusion of the full sequence, the train will pull away from the station in whatever direction you were going when you activated the feature.
- You can use FYS/PSA even if you are double-heading with another engine. If the second engine is not equipped with Proto-Sound 2.0, you must remember not to leave the throttle at a high voltage level once you have stopped the engine to run the FYS/PSA. Otherwise, the engine without FYS/PSA will begin vibrating on the track as its motors strain to move the train, since they cannot be automatically disabled during the FYS/PSA cycle (or if an original Proto-Sound engine, FYS/PSA are triggered differently and that engine's motor-disable feature will not be active when you run FYS/PSA in Proto-Sound 2.0).
- FYS/PSA can be triggered from Neutral. It will operate the same as if triggered while in motion except that, at the conclusion of the FYS/PSA, the engine will depart in the next direction of travel, as opposed to the direction it was traveling before entering Neutral.

Proto-Coupler™ Operation

This locomotive is equipped with one or more coil-wound Proto-Couplers for remote uncoupling action. Because Proto-Couplers are controlled through the Proto-Sound 2.0 microprocessor, they do not require an uncoupling track section or modification to your layout to function. You can fire a coupler from neutral or while in motion. Use the code shown below (and in the chart on page 8) to fire the coupler(s).

Rear Coupler:

To fire the rear coupler, quickly tap the Bell button once followed by three quick taps of the Whistle button, allowing approximately 1/2 second to lapse between each quick button press. The sound of the liftbar and air line depletion will play, and the knuckle will be released.

Front Coupler:



To fire the front coupler (if your engine has one), quickly tap the Bell button once followed by four quick taps of the Whistle button, allowing approximately ½ second to lapse between each quick button press. The sound of the liftbar and air line depletion will play, and the knuckle will be released.



Speed Control:

M.T.H. engines equipped with Proto-Sound 2.0 have speed control capabilities that allow the engine to maintain a constant speed up and down grades and around curves, much like an automobile cruise control. You can add or drop cars on the run, and the engine will maintain the speed you set.

While the engine is programmed to start with the speed control feature activated, you can opt to turn it off. This means the engine's speed will fall as it labors up a hill and increase as it travels downward. It is also affected by the addition or releasing of cars while on the run. Because the engine will run more slowly at a given throttle voltage when speed control is on than when it is off, you should adjust the throttle to a lower power level for operation with speed control off to avoid high-speed derailments. When speed control is off, the volume will drop to allow for better low voltage operation.

To turn speed control on and off, put the engine in neutral, then quickly tap the transformer's whistle button one time then quickly tap the Bell button two times, allowing approximately ½ second to lapse between each quick button press. Repeat the 1 whistle, 2 bells code to return it to the other condition. You will want to do this during the initial neutral upon start-up if you ever couple this engine to another engine that is not equipped with speed control to avoid damaging the motors in either engine. Each time you shut down the engine completely, it will automatically turn speed control on.



Lock into a Direction:

You can lock your engine into a direction (forward, neutral, or reverse) so that it will not change directions. To do this put the engine into the direction you want (or into neutral to lock it into neutral), run it at a very slow crawl (as slowly as it will move without halting), and quickly but firmly tap the Whistle button once followed by three quick taps of the Bell button, allowing approximately ½ second to lapse between each quick button press. Two whistle blasts will indicate that the engine has made the change. The engine will not change direction (including going into neutral) until you repeat the 1 whistle, 3 bells code to return the engine to its normal condition, even if the engine is kept without power for extended periods of time.



Reset to Factory Defaults:

To override the settings you currently have assigned to the engine and reset it to its factory defaults, while in Neutral tap the Whistle button quickly once, followed by five quick taps of the Bell button, allowing approximately 1/2 second to lapse between each quick button press. Two whistle blasts will indicate that the engine has made the change.



Automatic Sounds:

Certain Proto-Sound 2.0 sound effects automatically play in programmed conventional mode conditions:

- **Squealing Brakes** play any time the engine's speed decreases rapidly.
- **Cab Chatter** plays at random intervals when the engine idles in neutral.
- **Engine Start-up and Shut-down** sounds play when the engine is initially powered on or is powered off for five seconds or more.

Maintenance



Lubricating and Greasing Instructions

The engine should be well oiled and greased in order to run properly.

You should regularly lubricate all side rods, linkage components and pickup rollers to prevent them from squeaking. Use light household oil and follow the lubrication points marked “L” below. Do not over-oil. Use only a drop or two on each pivot point.

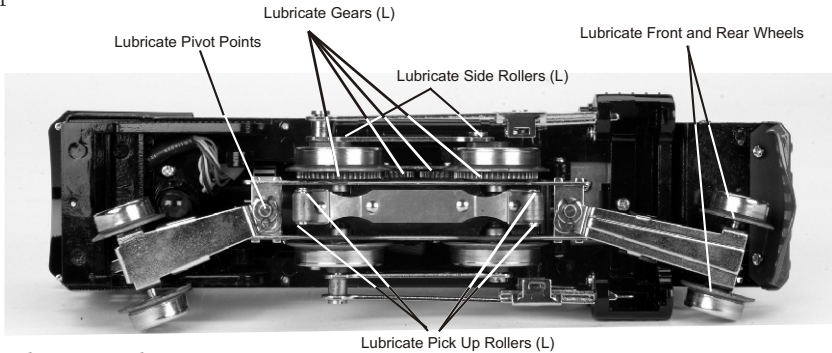

Lubricating the Locomotive

Removing the Boiler

The locomotive’s internal gearing was greased at the factory and should not need additional grease until after 50 hours of operation or one year, whichever comes first. To access the gear box and axles, do the following:

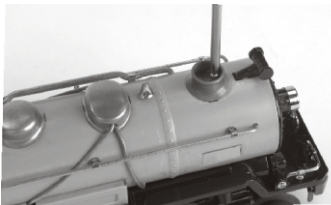

1. Remove screw from top of engine.

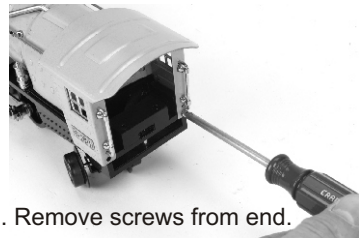

2. Remove screws from end.

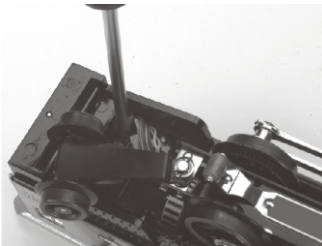

3. Remove screws from bottom of engine.

4. Remove body and unscrew gear box

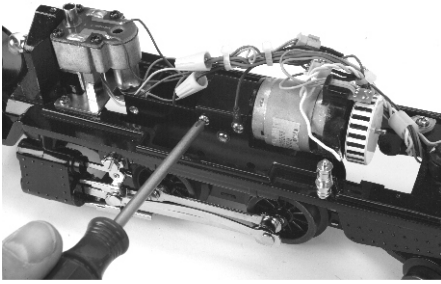

5. Remove cap from gear box.

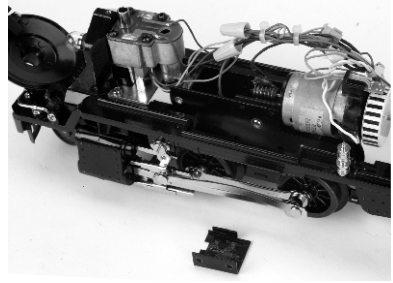

6. Use a grease tube dispenser to put a small amount (1-2ml.) of lithium-based grease into the gearbox and axles. Reassemble engine in reverse order.

Cleaning The Wheels, Tires, and Track

Periodically check the locomotive wheels and pickups for dirt and buildup, which can cause poor electrical contact and traction and prematurely wear out the neoprene traction tires. Wheels and tires can be cleaned using denatured (not rubbing) alcohol applied with a cotton swab.



To clean the track, use RailKing Track Cleaning Fluid found in Maintenance Kit (30-50010) or denatured (not rubbing) alcohol and a clean rag. Unplug the transformer and wipe the rails of the track, turning the rag frequently to ensure that you are using clean cloth on the rails. Thereafter, keep an eye on the track and clean it when it gets dirty to ensure good electrical contact and to lengthen the life of the tires.

Clean any type of track with this heavy-duty track cleaning block (40-1099). Durably constructed from ABS plastic, the block includes a built-in cleaning pad. For really stubborn track, you can insert sandpaper into the block in just a few quick steps.



Track Cleaning Block (40-1099)



Maintenance Kit (30-50010)

Traction Tire Replacement Instructions

Your locomotive is equipped with two neoprene rubber traction tires on the rear set of flanged drivers. While these tires are extremely durable, they may occasionally need to be replaced.

STEP
1

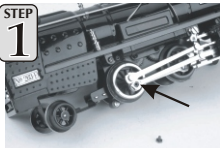

- Remove the side rods (the rods that connect each drive wheel to the other) from the wheels in order to slip the new tire over the grooved drive wheel. These bolts can be loosened with a 5mm nutdriver.
- Clean the groove using a cotton swab and denatured alcohol.

STEP
2

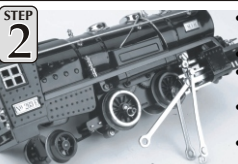

- Make sure the old tire has been completely removed from the groove in the drive wheel, using a razor blade or small flathead screwdriver to pry away any remains. Clean the groove using a cotton swab and denatured alcohol.
- Slip the new tire onto the wheel. You may find it useful to use two small flathead screwdrivers to stretch the tire over the wheel.
- If you twist the tire while stretching it over the wheel, you will need to remove and reinstall the tire. Otherwise your engine will wobble while operating.
- Make sure the tire is fully seated inside the groove. Use a razor blade to trim away any excess tire that doesn't seat itself inside the groove properly.

ProtoSmoke™ Unit Operation

This steam locomotive contains a smoke unit that outputs smoke through the smokestack on the boiler of the engine. The smoke unit is essentially a small heating element and wick that soaks up and then heats a mineral oil-based fluid that emits a harmless smoke. The smoke is then forced out of the stack by a small electric fan. With a few easy maintenance steps, you should enjoy trouble-free smoke unit operation for years.

- When preparing to run this engine, add 15-20 drops of smoke fluid through the smokestack. We recommend M.T.H. ProtoSmoke fluid (a small pipette of ProtoSmoke fluid is included). Do not overfill the unit or the fluid may leak out and coat the interior engine components.
- If you choose not to add the fluid (or have already added the fluid but choose to run smoke-free), turn off the smoke unit control (Full Counter Clockwise Position) located under the tender body. **Failure either to add fluid to the unit or to turn it off may damage the smoke unit heating element and/or wicking material.**
- When the smoke output while running the engine begins to



Smoke Unit Cover



Wick in Poor Condition



Wick in Good Condition

Your No. 260 or 263 Locomotive will be paired with one of the following styles of tender. Please reference the picture for your locomotive.

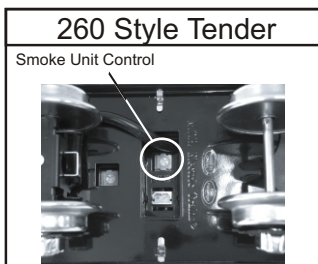

- diminish, add another 10-15 drops of smoke fluid or turn the smoke unit off.
- When storing the unit for long periods of time, you may want to add about 15 drops of fluid to prevent the wick from drying out.
- After removing the engine from storage, add another 25 drops of fluid, letting the wick soak up the fluid for 15 minutes prior to operation.

If you experience poor or no smoke output when the smoke unit is on and has fluid, check the wick to see if it has become hard, blackened, and unabsorbent around the heating element. Remove the boiler shown on Page 12 “Removing the Boiler”. Remove the smoke unit inspection cover from the locomotive's body (shown on page 14). After removing the chassis and inspection cover screws, lift the inspection plate away and inspect the wick. If it is darkly discolored and hard, it should be replaced. When priming new wick add 40 drops.

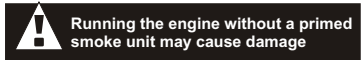

ProtoSmoke™ Fluid

ProtoSmoke is the recommended fluid for M.T.H. products and can be used in other manufacturers products as well. Choose from 12 different scents: Christmas, Coal, Diesel, Wood Burning, Coffee, Eggs & Bacon, Vanilla, Candy Cane, Barbeque, Pipe Smoke, Cinnamon Roll, and Apple Pie



Locomotive Lightbulb Replacement

The locomotive’s lights are controlled by a constant voltage circuit in the engine. They are easy to remove and replace when they burn out. See the diagrams and directions below for instructions on accessing and replacing the light bulbs in this locomotive.

You can obtain replacement bulbs directly from the M.T.H. Parts Department (Order online: www.mth-railking.com, e-mail: parts@mth-railking.com, Fax: 410-423-0009, Phone: 410-381-2500, Mail: 7020 Columbia Gateway Drive, Columbia MD 21046-1532)

1. To replace the headlight in this model you will need to pull back (release) the Boiler Front Latch and carefully pivot the boiler front forward. (See below).
2. Remove the bulb by unscrewing it counter-clockwise
3. Reassemble in reverse order, being careful not to pinch any wires

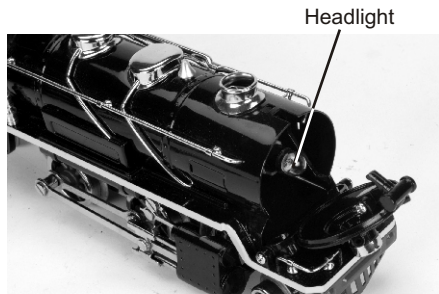
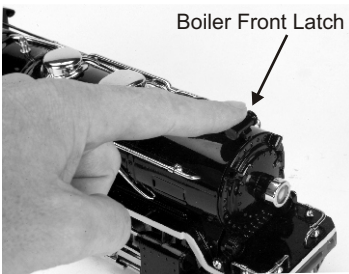

Caboose Light Bulb Replacement

To replace the interior light bulbs follow these instructions and see the diagrams below.

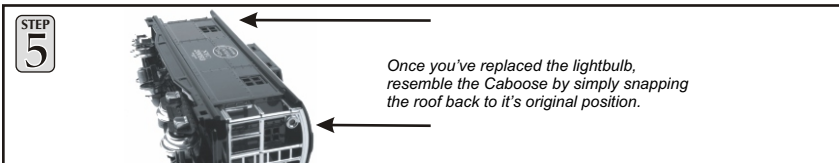
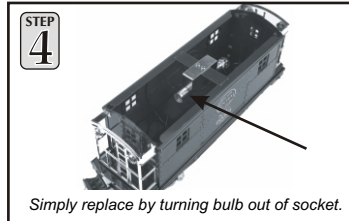
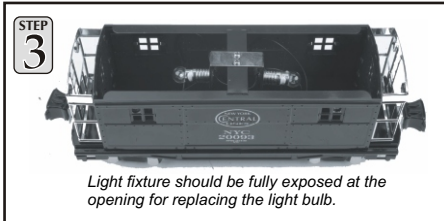
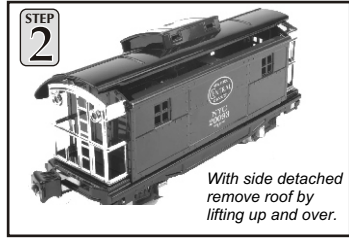
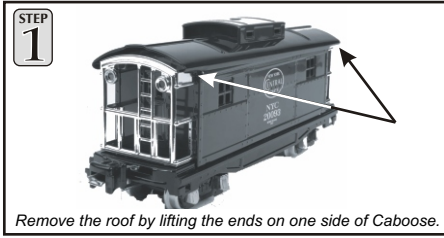

Self Charging Battery Back-up

The special rechargeable 2.4v self-charging battery recharges continuously during train operation and should last for up to five years. The battery is a dry battery that should not leak or cause any damage to your engine. Depending upon when your engine was built, it may need to be charged right out of the box. If engine sounds seem distorted or garbled at low voltages or become silent when power from the transformer is turned off, test the battery to determine whether it should be recharged or replaced.

Test: Put the engine in neutral and leave the track voltage at 10-12 volts (high enough for the lights to shine brightly) for 15 minutes.

Recharge: If the sounds are improved at the end of the 15-minute test charge, the battery charge has run down and can be recharged. There are a number of ways you can do this:

- Leave the engine in neutral with track voltage at 10-12 volts for 6-7 hours so the battery can fully recharge (if your engine has a smoke unit, be sure it is turned off).
- Use M.T.H.'s battery recharger (Item No. 50-1019) (sold separately) that plugs into a wall outlet and a special port under the engine to recharge the battery overnight without leaving it on the track.

Replace: If the sounds are not improved at the end of the 15-minute test charge, it is time to replace the battery. Available through M.T.H. Parts:
(Item No. 50-1024) AA NiCad Proto-Sound® Battery (Blue Casing)
(Item No. BG4000004) AAA NiMH Proto-Sound® Battery (Green Casing)

DO NOT substitute alkaline batteries for these rechargeable batteries. Using alkaline batteries in this system can result in damage to the PS 2.0 circuit board and/or the batteries.

Do not use alkaline batteries for testing or checking purposes for the 3-Volt PS2 boards. Using alkaline batteries will damage the 3-Volt battery charging circuit.

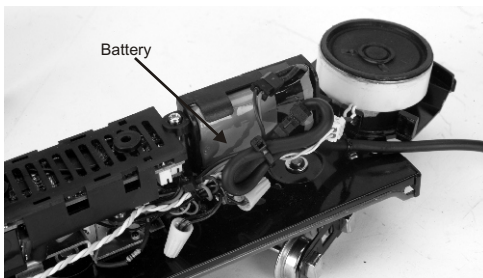

Battery Location

Self Charging Battery Back-up continued

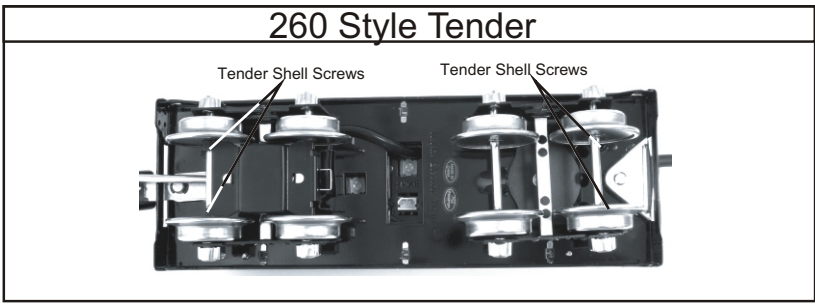
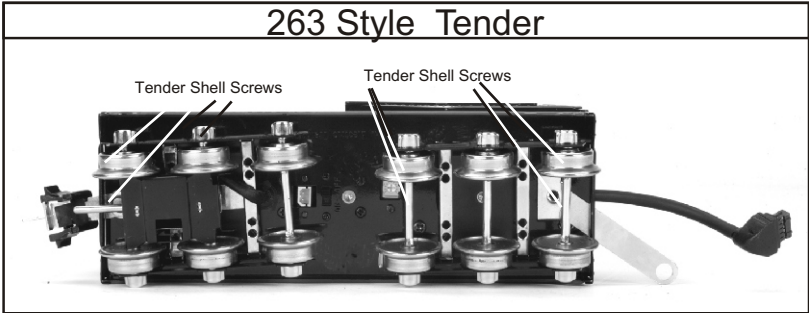

Tender Shell Screw Locations

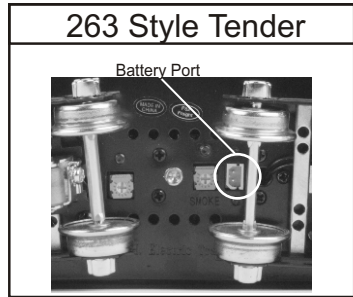
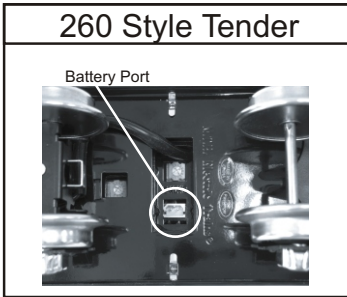

Battery Recharging Port

Quick-Start DVD

The included Quick-Start DVD demonstrates the start-up and basic operation of this set as well as other information about model railroading. You may find it helpful to view the DVD before operating this set.

RailWare Interactive DVD

M.T.H. provides a free RailWare DVD in each Ready-To-Run set. It is full of helpful information on M.T.H. product history, track planning software, a dealer finder, and information and video clips on Loco-Sound and Proto-Sound 2.0. Follow the directions below to use the DVD .

Minimum System Requirements: Pentium 100, 16MB RAM, Windows 95 or later, DVD drive, Sound Card, display properties set to greater than 256 colors. The DVD will not work on a Mac OS unless you run VirtualPC®.

Running RR-Track Software

You may run the RR-Track software directly off of the DVD or you may install the software to your hard drive.

1. On the Desktop, click on the icon that says My Computer.
2. Find your DVD drive.
3. With the M.T.H. DVD in the drive, double click on the icon for the DVD drive.
4. Find the folder on the DVD entitled INSTALLATION.
5. Choose the folder inside entitled RRTRAXSETUP.
6. Run the file in that folder called SETUP.EXE and follow the directions it provides.

The program may ask you for a registration code. If it does type in "M.T.H." and it will run.

Additional track libraries can be obtained directly from RR-Track. See their website for more information www.rtrack.com.

Installing Adobe Acrobat Software

To read some of the electronic documents included on the DVD , you will need to install the Adobe Acrobat Reader® if it is not already on your computer. To install the software:

1. On the Desktop, click on the icon that says My Computer.
2. Find your DVD drive.
3. With the MTH DVD in the drive, double click on the icon for the DVD drive.
4. Find the folder on the DVD entitled INSTALLATION.
5. Choose the folder inside entitled ACROBAT READER.

*If you are running Windows 95, 98 or NT choose the folder 32 BIT. Run the file AR32E301.EXE and follow the directions it provides.

If you have problems you cannot resolve by using these directions, contact custserv@mth-railking.com or call 410-381-2580 for further help.

Troubleshooting Proto-Sound® 2.0 Problems

Although Proto-Sound® 2.0 has been designed and engineered for ease of use, you may have some questions during initial operation. The following table should answer most questions. If your problem cannot be resolved with this table, contact M.T.H. for assistance (Online: www.mth-railking.com, e-mail: parts@mth-railking.com, Fax: 410-423-0009, Phone: 410-381-2500, Mail: 7020 Columbia Gateway Drive, Columbia MD 21046-1532)

Starting Up	Remedy
When I first turn the power on, the engine will not begin to run.	This is normal behavior. To prevent accidental high-speed start-ups, Proto-Sound 2.0 is programmed to start up in neutral anytime track power has been turned off for several seconds. See the "Basic Operation" section for more details.
The engine will not start after I press the Direction button.	You may not be sending enough power to the track to power the engine. Press the throttle up for a few more seconds to increase track power.
My engine sounds are distorted and garbled.	The battery may have run down, especially if the engine has been in storage for some time. See the "Self-Charging Battery Back-Up" section of these instructions for how to test, recharge, and (if necessary) replace the battery.
Whistle	Remedy
I can't get the whistle to blow when I press the whistle button.	You may be pressing the button too quickly. Try pressing the Whistle button more slowly, taking approximately one full second to fully depress the button.
Bell	Remedy
I can't get the bell to ring when I press the bell button.	You may be pressing the button too quickly. Try pressing the bell button more slowly, taking approximately one full second to fully depress the button.
Coupler	Remedy
When I try to fire the coupler, FYS/PSA starts.	You are waiting too long between whistle button presses. See the timing instructions located at the beginning of the "Proto-Sound 2.0 Operating Instructions" section.
The Proto-Coupler won't let the engine uncouple on the fly.	Try lubricating the coupler knuckle and rivet with a dry graphite lubricant.
The coupler does not fire or stay coupled.	The coupler needs to be cleaned. Wipe with denatured alcohol (not rubbing alcohol) and let dry.
Cab Chatter	Remedy
Sometimes the Cab Chatter sounds don't play.	Cab Chatter plays only in neutral at random intervals.
Lock-out	Remedy
I can't get the engine to run after I power up the transformer. It sits still with the diesel and compressor sounds running. The engine won't lock into forward, neutral, or reverse.	The engine maybe locked into the neutral position. Follow the procedure in the "Lock into a Direction" section to unlock the engine's direction. Engine speed must be below 10 scale mph (approx. 10 volts or less in conventional mode).

Volume	Remedy
The sounds seem distorted, especially when the whistle or bell is activated.	Proto-Sound 2.0 volume is set too high. Turn the volume control knob on the bottom of the tender counter-clockwise to reduce the volume.
No Sound	Volume is set too low, adjust volume control knob on the bottom of the tender clockwise to increase the volume or check connector to speaker.
Battery	Remedy
The engine will not leave the initial neutral setting.	Check to be sure the battery is installed and fully charged. See the "Self-Charging Battery Back-Up" section.
I get no sounds when the engine shifts between directions.	The battery may be dead or need to be charged. See the "Self-Charging Battery Back-Up" section.
After I turn off my transformer, my engine continues to make sounds before quitting.	Proto-Sound 2.0 is designed to continue to sound for a few seconds after power to the track has been shut off to allow for a more realistic shut-down.
FYS/PSA	Remedy
The FYS/PSA sounds occasionally repeat themselves.	Proto-Sound 2.0 has a built-in random number generator that randomly selects each sound clip to play. Because there are a limited number of sound clips available in each FYS/PSA sequence, it is probable that some of these sound clips will be repeated from time to time.
Once in FYS/PSA, the engine doesn't go into reverse.	So that FYS/PSA effects can be as realistic as possible, Proto-Sound 2.0 disables the reversing unit whenever FYS/PSA is enabled. This way the engine remains still at its stop as the operator cycles through the FYS/PSA sequences.
When the FYS/PSA enters its last sequence the bell automatically comes on	FYS/PSA is programmed to start ringing the bell at that point. After approximately 12 seconds, it will automatically turn off.
When FYS/PSA is enabled, pressing the whistle and bell has no effect	Because FYS/PSA must control various effects in each sequence, Proto-Sound 2.0 takes control of these sound effects until you exit FYS/PSA
I push the direction button but the next sound clip in the sequence does not play or the engine does not come out of FYS/PSA after fourth press of the direction button.	Each FYS/PSA clip must play for aprox. 30 seconds before FYS/PSA will advance to the next step in the FYS/PSA cycle. Wait at least 30 seconds in each FYS/PSA sound clip before pressing the direction button.

Compatibility

While this Ready-To-Run set is equipped with everything you need to operate it, the design allows flexibility. The train will operate on any traditional O-31 or larger O Gauge track system, including the ScaleTrax™ included with this set or traditional tubular track. It is also compatible with most standard AC transformers, including the hobby transformer packaged with your set.

Transformer Compatibility and Wiring Chart

Proto-Sound® 2.0 is designed to work with most standard AC transformers. The chart below lists the many compatible transformers. Note that many of the operational commands described in these instructions require a bell button, so if your transformer does not have its own bell button, you should consider adding one to get the full benefit of the system. In addition, the chart details how the terminals on these transformers should be attached to your layout.

RECOMMENDED AC TRANSFORMERS					
Transformer Model	Center Rail	Outside Rail	Min/Max. Voltage	Power Rating	Transformer Type
MTH Z-500	Red Terminal	Black Terminal	0-18v	50-Watt	Electronic
MTH Z-750	Red Terminal	Black Terminal	0-21v	75-Watt	Electronic
MTH Z-1000	Red Terminal	Black Terminal	0-21v	100-Watt	Electronic
MTH Z-4000	Red Terminal	Black Terminal	0-22v	390-Watt	Electronic
Lionel 1032	U	A	5-16v	90-Watt	Standard
Lionel 1032M	U	A	5-16v	90-Watt	Standard
Lionel 1033	U	A	5-16v	90-Watt	Standard
Lionel 1043	U	A	5-16v	90-Watt	Standard
Lionel 1043M	U	A	5-16v	90-Watt	Standard
Lionel 1044	U	A	5-16v	90-Watt	Standard
Lionel 1053	U	A	8-17v	60-Watt	Standard
Lionel 1063	U	A	8-17v	60-Watt	Standard
Lionel LW	A	U	8-18v	75-Watt	Standard
Powermaster	U	A	8-18v	135VA	Electronic
All-Trol	Left Terminal	Right Terminal	0-24v	300-Watt	Electronic
Dallee Hostler	Left Terminal	Right Terminal			Electronic
Lionel LW	A	U	8-18v	75-Watt	Standard
Lionel KW	A or B	U	6-20v	190-Watt	Standard
Lionel MW	Outside Track Terminal	Inside Track Terminal	5-16v	50V.A.	Electronic
Lionel RS-1	Red Terminal	Black Terminal	0-18v	50V.A.	Electronic
Lionel RW	U	A	9-19v	110-Watt	Standard
Lionel SW	U	A	Unknown	130-Watt	Standard
Lionel TW	U	A	8-18v	175-Watt	Standard
Lionel ZW	A,B,C or D	U	8-20v	275-Watt	Standard
Lionel Post-War Celebration Series ZW	A,B,C or D	Common	0-20v	135/190 Watt	Electronic

* Conventional Mode Only

Additional Features Accessible with the DCS Remote Control System: (additional equipment required)

While conventional mode operation of a Proto-Sound® 2.0 engine yields wonderfully realistic sound and several train control features, command mode operation allows the user to access a world of command functions never before accessible to O Gauge railroaders. With the addition of the DCS Remote Control System (including a DCS remote handheld and Track Interface Unit) users gain many advanced features, including:

- DCS Proto-Speed Control - Establishes desired locomotive speed in scale miles per hour increments via a thumbwheel control and allows operator to set maximum speed and acceleration/deceleration rates
- ProtoSmoke® Variable Output Control - Controls how much smoke each engine outputs and matches smoke to locomotive speed
- Locomotive Lighting Control - Controls locomotive headlights, marker and interior lights, beacon lights, ditch lights, and MARS lights
- Emergency Stop-Single button push stops all Proto-Sound 2.0 trains but does not turn off the power
- One Touch Global Mute/UnMute-Single button mutes or unmutes all DCS-controlled locomotives' user-defined actions, including sound, lights, and smoke
- Proto-Dispatch Operation-Public Address-like feature allows users to speak through locomotive speaker during operation
- Proto-Cast-Allows users to play audio recordings through locomotive speaker during operation
- Proto-Doppler Sound Effects Set Up-Users can configure locomotive for Doppler Operation, including setting distance points for Doppler start, repeat, and stop modes
- Independent Volume Control of Engine Sounds, Bell, Horn & Whistle for each Locomotive
- Control up to 50 different DCS-Equipped Locomotives at one time with multiple TIUs
- Proto-Effects™ Set Up-User can select individual Proto-Effects™ operations to be active or inactive, including cab chatter, train wreck sounds, coupler sounds, and wheel clickety-clack sounds
- Direction Control Set Up-User can set initial individual start-up direction (start in forward or reverse) for double-heading operations
- Locomotive Consist Set-up-User can determine locomotive values for consist make-ups, allowing multiple locomotives belonging to a consist to operate together
- Query Locomotive Information-User can query locomotive programming to learn locomotive address and engine data information, including scale miles traveled
- User Can Query, Set and Operate Track and Accessory Interface Units for Programming Digital Command Operations for up to 250 Accessories and 250 Individual Switches
- User Can Script, Record and Playback Train Routes

Operating instructions for all DCS Command features will accompany the DCS remote control equipment.

Service & Warranty Information

How to Get Service Under the Terms of the Limited One-Year Warranty

When you suspect an item is defective, please check the operator's manual for standard operation and troubleshooting techniques that may correct the problem. Additional information may be found on the M.T.H. Website. Should you still require service, follow the instructions below to obtain warranty service.

First, e-mail, write, call or fax M.T.H. Electric Trains or a M.T.H. Authorized Service Center (ASC) in your area to obtain Repair Authorization. You can find the list of ASCs on the M.T.H. Website, www.mth-railking.com. Authorized Service Centers are required to make warranty repairs on items sold *only* from that store; all other repairs may-- or may not be done at the store's own discretion. If you did not purchase the item directly from the ASC, you will need to select a National Authorized Service Center (NASC) or contact M.T.H. Electric Trains directly. NASC Dealers are compensated by M.T.H. to perform warranty service for any customer whose repair qualifies for warranty service. A list of NASC retailers can be located on the M.T.H. Website or by calling 410-381-2580. Should the warranty no longer apply, you may choose either an ASC or NASC retailer to service your M.T.H. Product. A reasonable service fee will be charged.

CAUTION: Make sure the product is packed in its original factory packaging including its foam and plastic wrapping material to prevent damage to the merchandise. There is no need to return the entire set if only one of the components is in need of repair *unless otherwise instructed by the Service Center*. **The shipment must be prepaid and we recommend that it be insured. A cover letter including your name, address, daytime phone number, e-mail address (if available), Return Authorization number (if required by the service center, a copy of your sales receipt and a full description of the problem must be included to facilitate the repairs. Please include the description regardless of whether you discussed the problem with a service technician when contacting the Service Center for your Return Authorization.**

Please make sure you have followed the instructions carefully before returning any merchandise for service. Authorized M.T.H. Service Centers are independently owned and operated and are not agents or representatives of M.T.H. Electric Trains. M.T.H. assumes no responsibility financial or otherwise, for material left in their possession, or work done, by privately owned M.T.H. Authorized Service Centers. If you need assistance at any time email MTH Service at service@mth-railking.com, or call 410 381-2580.

Limited One-Year Warranty

All M.T.H. products purchased from an Authorized M.T.H. Retailer are covered by this warranty. See our Website to identify an Authorized M.T.H. Retailer near you.

M.T.H. products are warranted for one year from the date of purchase against defects in material or workmanship, excluding wear items such as light bulbs, pick-up rollers, batteries, smoke unit wicks, and traction tires. We will replace or credit (at our option) any defective item with a manufactured suggested retail price of \$279.95 or less (excluding all motive power and electronic items), if the item is returned to an M.T.H. Authorized Service Center (ASC) or M.T.H. National Authorized Service Center (NASC) within one year of the original date of purchase. For any item with an MSRP greater than \$279.95 (including all motive power and electronics), We will repair, replace or credit (at our option) the defective item without charge for the parts or labor, if the item is returned to an M.T.H. Authorized Service Center (ASC) or M.T.H. National Authorized Service Center (NASC) within one year of the original date of purchase. This warranty does not cover damages caused by improper care, handling, or use. Transportation costs incurred by the customer to ship the product for warranty service are not covered under this warranty.

Items sent for repair must be accompanied by a return authorization number, a description of the problem, and a copy of the original sales receipt from an Authorized M.T.H. Retailer stating the date of purchase. If you are sending this product to an Authorized Service Center, contact that Center for their return authorization.

This warranty gives you specific legal rights, and you may have other rights that vary from state to state. Specific questions regarding the warranty may be forwarded to M.T.H. directly

Service Department
M.T.H. Electric Trains
7020 Columbia Gateway Drive
Columbia MD 21046-1532
410-381-2580
service@mth-railking.com