

RAILKING[®]
By M.T.H. Electric Trains

30-4086-1

S-2 Turbine

6-8-6



Ae093002

6-8-6 Turbine Steam Engine

Engine Parts

Name and Number	Part #	\$Price Per Unit	Name and Number	Part #	\$Price Per Unit
1.) Stanchion (black) (plastic)(3.0mm long)	FB-1200242	0.50	36.) Washer (5.0x12.0x0.6mm)	ID-0000053	0.15
2.) Handrail (nickel) (20.0x207.0mm)(right)	FB-1210040	2.00	37.) Truck (black) (trailing)(boiler)(3 axle)	DA-1240033	30.00
3.) Handrail (nickel) (20.0x207.0mm)(left)	FB-1220047	2.00	38.) Spacer (black) (7.0x9.0x4.0mm)(metal)	ID-0000096	1.00
4.) Shell (Brunswick green, gray) (Pennsylvania)(#6200)(cast metal)	FB-1200185	*100.00	39.) Screw (6/32x6.0mm)(washer head)	IA-0000214	0.15
5.) Marker lens (green) (2.2x13.3mm)(2.8x1.2)(plastic)	FA-1230003	1.00	40.) Screw (6/32x8.0mm)(roundhead)	IA-0000050	0.15
6.) Lens (clear) (headlight)(7.0x6.0x13.0mm)	FA-1230022	2.00	41.) Nut (nickel)(2.5x5.0x10.0mm)	IC-0000005	0.50
7.) Number plate (Tuscan & gold) (Keystone)(#6200)	FB-1230005	4.00	42.) Insulator (black) (pick-up)(bottom)(square)	BD-0000001	2.00
8.) Smoke unit (Proto-Sound® 2.0)	AA-0000029	50.00	43.) Pin (black)(3.1x14.8mm) (6.0x1.0mm rounded head) (1 e-clip groove 0.5mm out from end)	IG-0000003	1.00
9.) Bulb (clear)(6v) (small globe)(screw base)(headlight)	CA-0000038	1.00	44.) Bracket (black) (37.0mm long)(1.0mm thick)(2 bends)(lead truck)	GA-1200068	3.00
10.) Screw (4/40x6.0mm)(roundhead)	IA-0000003	0.15	45.) Spring (nickel) (6.5x9.0mm)(0.5mm thick wire)	IE-0000009	0.50
11.) Bracket (black)(metal) (3 step)(headlight/smoke unit)	IH-0000172	3.00	46.) E-clip (2.5x6.0x0.5mm)	IF-0000004	0.15
12.) Traction tire	DE-0000022	0.75	47.) Insulator washer (white) (6.0x4.0x2.5mm)(plastic)	ID-0000033	0.15
13.) Bolt (M3x8.0mm)(nickel) (5.0mm hex head)(4.0x2.5mm shoulder)	IA-0000087	1.00	48.) Voltage regulator (LM2937ET)	AG-0000032	3.00
14.) Side rod (nickel) (1.0x85.0mm)(4 holes)	EC-1250024	2.00	49.) Insulator (clear) (13.0x19.0x0.1mm)(single hole)	ID-0000024	0.15
15.) Drive block (black)(4 axle)	DF-1200028	*75.00	50.) Truck (black) (boiler)(lead)(3 axle)	DA-1230023	30.00
16.) Insulator (black)(pick-up) (top)(square)(has mounting tab on top left)	BD-0000047	2.00	51.) Spacer (black) (3.5x15.0x2.5mm)(metal)(cupped)	ID-0000014	1.00
17.) Screw (nickel) (M3x6.0mm)(roundhead)	IA-0000015	0.15	52.) Pick-up (8.0x11.0mm roller)(28.0mm long)	BD-0000048	5.00
18.) Screw (4/40x12.0mm)(roundhead)	IA-0000264	0.15	53.) Screw (4/40x4.0mm)(roundhead)	IA-0000021	0.15
19.) Bracket (Aluminum) (Proto-Sound 2.0®)	IH-0000170	3.00	NS.) Wire harness (10 pin green female PC board)	BC-1200019	15.00
20.) Boards (Proto-Sound® 2.0)	AE-0000001	*200.00	NS.) Wire harness (7 pin black male plug)	BC-1200014	8.00
21.) Screw (M2x4.0mm)(roundhead)	IA-0000058	0.15	NS.) Wire harness (5 pin black male plug)	BC-1200015	5.00
22.) Switch (small)	BB-0000009	5.00	NS.) Wire harness (4 pin black male plug)	BC-1200020	4.00
23.) Screw (yellow Zinc) (M2.5x6.0mm)(roundhead w/ lock washer)	IA-0000089	0.15			
24.) Screw (6/32x10.0mm)(roundhead)	IA-0000040	0.15			
25.) Motor mount (black)	BI-0000034	15.00			
26.) Screw (6/32x6.0mm)(roundhead)	IA-0000027	0.15			
27.) PC board (green) (w/ 10 pin female plug)	AG-0000039	8.00			
28.) Tach board	AG-0000033	6.00			
29.) Motor (RS-365SH) (8.0x21.0mm worm gear)(13.0mm long threads) (9.0x30.0mm white flywheel w/ black stripes) (tach board mounting strap)	BE-0000076	25.00			
30.) Wire nut (yellow)	BI-4500003	0.25			
31.) Pin (5.0x25.0mm)(black) (8.0x1.5mm flathead)(2 e-clip grooves)	IG-0000033	0.50			
32.) Draw bar (black) (10.0x105.0mm)(multiple bend w/ tender hook)	FB-1200183	3.00			
33.) Washer (5.0x12.0x0.8mm)	ID-0000012	0.15			
34.) E-clip (3.5x9.0x0.6mm)	IF-0000009	0.15			
35.) Spring (conical) (6.0x12.5x13.0mm)(0.6mm thick wire)	IE-0000062	0.50			

*Requires Exchange
All parts are priced as each

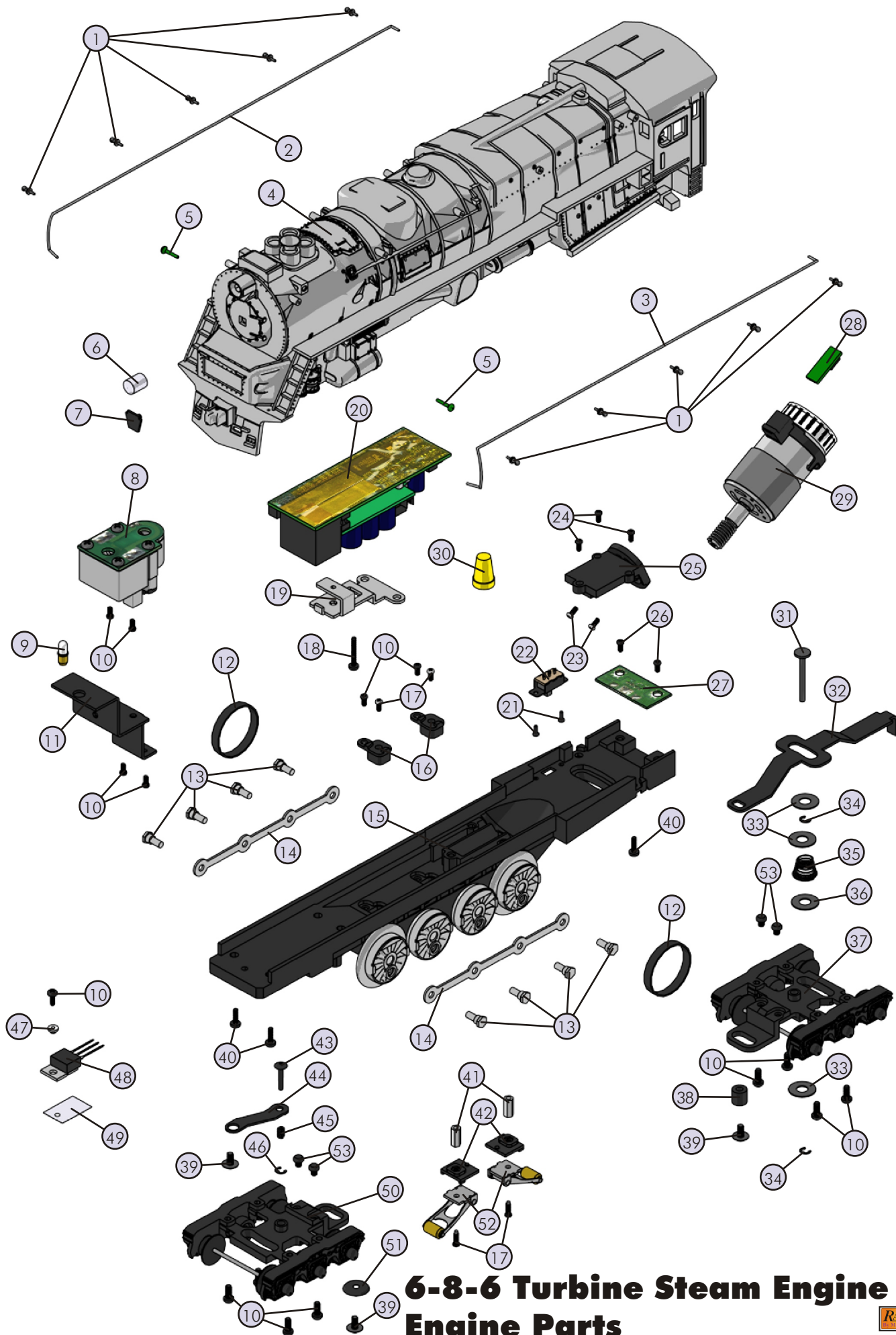

6-8-6 Turbine Steam Engine Engine Parts

6-8-6 Steam Turbine Tender

Tender Parts

Name and Number	Part #	\$Price Per Unit
1.) Shell (Brunswick green) (plastic)(Pennsylvania)	GA-1200069	*40.00
2.) Weight (black) (metal)(34.4x39.3x19.8mm) (w/ 3 holes tapped for 4/40 screws)	II-0000015	5.00
3.) Wire harness (black male 10 pin plug)	BC-1200105	12.00
4.) Screw (4/40x6.0mm)(roundhead)	IA-0000003	0.15
5.) Battery charger jack (black)	BG-0000001	3.00
6.) Screw (M2x4.0mm)(roundhead)	IA-0000058	0.15
7.) Spacer (black) (3.0x6.0x4.0mm)(plastic)	ID-0000071	0.15
8.) Volume pot (small)(blue)	BI-0000040	5.00
9.) Screw (M3x8.0mm)(roundhead)	IA-0000035	0.15
10.) Speaker (STAR)(PR-050-A111)(16 ohms)(MAX 2W)	BF-0000007	8.95
11.) Speaker cone (black) (44.0x48.3x23.0mm)(2 screw hole tabs)(plastic)	BF-0000016	5.00
12.) Screw (M3x6.0mm)(roundhead)	IA-0000016	0.15
13.) Battery leads (60.0mm long wires w/ black male 2 pin plug) (45.0mm long wires w/ battery charger jack)	BC-0000101	6.00
14.) Battery	BG-4000001	10.00
15.) Bracket (battery)	IH-0000042	3.00
16.) Screw (M3x4.0mm)(roundhead)	IA-0000010	0.15
17.) Gasket (black) (speaker ring)(43.8x49.8x3.0mm)(foam)	IB-0000009	0.50
18.) Chassis (black)(tender) (has holes for battery charger jack)	GB-1200048	*15.00
19.) Screw (M3x16.0mm)(washer head)(self-drilling threads)	IA-0000025	0.15
20.) T-bar	IG-0000001	0.50
21.) Coupler (Proto Sound® 2.0) (51.0mm long)	DD-0000032	10.00
22.) Spring (nickel) (6.5x14.0mm)(w/ 0.5mm thick wire)	IE-0000022	0.50
23.) Washer (4.5x10.0x5.0mm)	ID-0000009	0.15
24.) E-clip (3.0x8.0x0.5mm)	IF-0000001	0.15
25.) Screw (6/32x6.0mm)(washer head)	IA-0000214	0.15
26.) Truck (black) (3 axle)(leading/trailing)(tender)	DA-1250005	25.00
27.) Draw bar (60.7x10.0x1.2mm)(1 step, 2 bends) (2 large holes, 1 small hole)	GA-1200027	3.00
28.) Wire strap (black) (8.0x16.0mm)(6.0mm step)	IH-0000256	3.00
NS.) Axle bearing (black) (3 axle)(plastic)	DC-0000005	3.00

*Requires Exchange
All parts are priced as each

6-8-6 Steam Turbine Tender

Tender Parts

