

2016 Ready-To-Run

O Gauge & Tinplate Train Sets & Accessories



EMT
ELECTRIC TRAINS®

The Highest Quality Train Sets You Can Buy

A World of Your Own in Three Dimensions



In a world where much childhood play takes place on a two-dimensional screen, model railroading offers a form of play that is both old-fashioned and timeless. For more than a hundred years, children have been using toy trains — along with construction sets, toy figures, empty boxes, and anything else at hand — to build their own imaginary worlds.

While all of this can be accomplished today on a computer screen, there's still enormous value in building something with your hands, making it operate, and sharing it with your friends. Childhood development experts call it “unstructured, imaginative, free play” and they say it helps kids grow mentally and socially. We just think it's fun, and having fun has to be a good thing.

It's all here

In this catalog, we offer everything you need to build a miniature world of your own — or just put up a train around the Christmas tree, or anything in between. You'll find trains that are realistic and others that are whimsical, like our Christmas and tinplate sets.

Each of our ready-to-run sets includes everything you need to get started, all in one box. To expand your layout, we offer well over a hundred RailTown™ buildings and accessories; track systems in O Gauge and Standard Gauge; and a variety of safe, UL-approved transformers.



Start With the Best

Like the toy trains of decades ago, our trains are designed to stand up to childhood play and provide years of enjoyment. Compare our sets with those of our competitors, and you'll find M.T.H. trains are made of better materials, run more smoothly, last longer, and offer more features.

We invite you now to turn the page and see what we have to offer. We hope you'll find items in this catalog that will surprise and delight you, and encourage you to begin a model railroading adventure of your own.

*To get the news as it happens, sign up for our **FREE** weekly electronic newsletter, with information on new M.T.H. products, industry news, and sneak peeks at upcoming specials!*

Just go to mthtrains.com and click on *Newsletter Signup*.



See it in Action!

When you see this  icon, search for the item number on www.mthtrains.com to see a video of the item in action — or scan this QR code to see all of the product videos for this catalog!

www.mthtrains.com/news/552

Contents

About M.T.H. Trains 2

Why an M.T.H. set is the best way to start your model railroading journey

Train Sets

All-in-one-box train sets in a variety of gauges, styles, and price ranges, each with everything you need to get started

O Gauge Steam 6

Separate Sale

2-8-0 Steam Locomotives..... 9

SD70ACe Heritage Sets..... 10

GE ES44AC Heritage Sets 14

ES44AC Engine & Caboose Set 18

EMD F3 Sets.....20

Bump-n-Go Trolley 23

Tinplate 24

Additional Cars.....26

Rolling stock to add color and interest to your layout

Accessories 38

Buildings, signals, people and other accessories to help create your imaginary world

Track and Layouts..... 64

Expand your empire with our O gauge and Standard Gauge track systems and layout packages

Transformers 84

As your layout grows, choose from a variety of transformers to satisfy increasing power needs — all UL-approved for safety

Digital Command System 86

When you're ready for the ultimate in 21st-century train control, check out DCS — the M.T.H. Digital Command System

M.T.H. Railroaders Club 90

www.mthtrains.com 92



www.mthtrains.com

M.T.H. TRAINS ARE MORE FUN!



M.T.H. trains are more fun because they feature the sights and sounds that make real trains dramatic and exciting — features that you can control from a handheld DCS Remote Commander* as you walk around your layout:

Great Smoke

Our steam engines feature fan-driven, puffing ProtoSmoke™, the most powerful smoke system in the hobby, and our Imperial diesel engines include variable intensity ProtoSmoke diesel exhaust.

Speed Control

Many toy trains have two speeds: fast and faster. Most M.T.H. locomotives feature the Proto-Sound® 3.0 sound and control system, which allows our engines

to throttle down as slow as 3 scale miles per hour, highball down the main line, or maintain any speed in between. The Proto-Speed Control™ built into Proto-Sound locomotives acts like the cruise control on a car, keeping your train moving at the speed you select, regardless of hills and curves.

Vivid Engine Sounds

Proto-Sound features crystal-clear digital sounds: the wail of a diesel horn; the melody of an authentic steam whistle; the bell alerting passengers to your arrival or departure; steam chuff or diesel roar; and crew conversations.

Station Sounds

Proto-Sound passenger engines feature arrival and departure

announcements of famous passenger trains. Freight engines include Freight Yard Proto-Effects™, a symphony of freight terminal sounds.

Synchronized Chuff and Puff

Like a real steam engine, M.T.H. steamers feature puffs of smoke and steam chuff sounds synchronized with the drive wheels. Better than any other toy train, an M.T.H. locomotive portrays the drama of a steam engine slowly chuffing and puffing as it pulls out of a station and gets up to speed.

Remote Uncoupling

O Gauge Proto-Sound steam and diesel engines offer remote uncoupling anywhere on your layout, accompanied by the clank of the coupler opening and the hiss of air hoses parting.

Remote Control

Virtually every M.T.H. ready-to-run train set includes a digital remote control. You can also control Proto-Sound 3.0-equipped train sets with your favorite smart phone or tablet when the set is operated with the full DCS Digital Command System featured on page 86.



* Sets cataloged as Proto-Sound 3.0 include the DCS Remote Commander; Loco-Sound sets include a traditional transformer rather than the Commander.

TWO WAYS to get started in MODEL RAILROADING

RailKing® O Gauge

O Gauge has been the most popular size for children's starter sets for more than half a century. Compared with smaller scales and gauges, the large size of O Gauge trains makes them easy for children to handle and better at standing up to the rigors of childhood play. Impressive size and weight also make an O Gauge train a memorable toy that can leave a long-term impression.

Lionel Corporation Tinplate Standard Gauge

Made of stamped or die-cast metal and boasting bright, colorful paint schemes, tinplate trains hark back to the toys of another era, the pre-World War II decades of the twentieth century. This was a period when silent movies and then radio were among the chief forms of entertainment, and playthings were not intended to be realistic, but to serve as springboards for a child's imagination.

In that world, the toy train was king, proclaimed by Popular Mechanics as "The One Toy That Guarantees a Happy Childhood." Journey back to that era with our Lionel Corporation Tinplate reproductions of Lionel trains of the 1920s and '30s, updated with modern Proto-Sound electronics for even more fun.

Significantly larger than O Gauge trains, Standard Gauge toy trains were popular before the invention of smaller electric motors made O Gauge trains possible. In the world of Standard Gauge, it was entirely plausible for a toy train company to advertise a shiny, cartoon-like locomotive as an amazingly realistic model of the latest technology on rails. The Standard Gauge world was inhabited by brightly-colored toys that were masterpieces of the toy-makers art, only loosely related to the real world, and a favorite toy of almost every boy in America.

While original Standard Gauge trains became extinct by the late 1930s, our Lionel Corporation Tinplate models enable you to relive the joy that a child felt when playing with these toys eight or nine decades ago. And thanks to Proto-Sound 3.0, you can enjoy these models with features that a child of the 1920s or '30s could only dream of, including clouds of puffing smoke, a wailing whistle, a clanging bell, and remote-controlled passenger station announcements.

Model Railroading Comes In Different Sizes



The Highest Quality Train Sets You Can Buy

QUALITY AND VALUE

Compare Before You Buy

At M.T.H., we consider the ready-to-run train set our best opportunity to make a great impression on any newcomer to the wonderful world of model railroading. That's why we don't skimp on the quality and value you'll find in every M.T.H. ready-to-run starter set. Compare our sets with those of our competitors and you'll see what makes an M.T.H. starter set the best way to begin your model railroading journey.

M.T.H. ready-to-run train sets include track, transformer, interactive DVD with track layout software and operator's manual.



Every M.T.H. passenger car has a lighted interior and metal trucks and couplers.

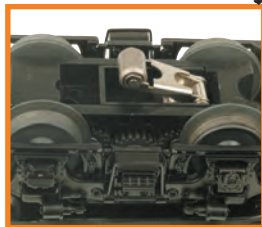

Every M.T.H. locomotive features durable metal gears, wheels and axles.



Every M.T.H. locomotive features a smooth, powerful drive train that can haul many additional cars.



Every M.T.H. Ready-To-Run Set features snap-together nickel-silver, rust-proof track, built to stand up to the rigors of childhood play. You can even stand on our O gauge track.



M.T.H. train sets feature powerful transformers and remote controls that can handle long trains as your railroad expands.



READY-TO-RUN SET FEATURES

As explained on the previous pages and detailed below, M.T.H. train sets are loaded with features you won't find in other manufacturers' sets. The following list covers the general features and contents of our train sets. For a specific listing of each set's features and contents, visit our Web site at www.mthtrains.com.

SET CONTENTS

O Gauge RailKing Sets include:

- Locomotive
- 3-Car passenger or freight consist with metal trucks and couplers
- 31" x 51" 12-piece RealTrax™ oval
- Lighted track Lock-On, with wires to connect to transformer or power supply
- UL-approved 50-watt Z-500™ power supply with DCS Remote Commander handheld remote control (Proto-Sound 3.0 sets) or Z-Controller (Loco-Sound sets)
- RailWare™ interactive DVD with track layout software

Standard Gauge Lionel Corporation Tinplate Sets include:

- Locomotive
- 2-Car passenger consist
- 8-piece 42" circle of Standard Gauge track
- Lighted track Lock-On, with wires to connect to power supply
- UL-approved 50-watt Z-500™ power supply with DCS Remote Commander handheld remote control

Check online at www.mthtrains.com for specific features and contents of all sets.



LOCOMOTIVE FEATURES

O Gauge RailKing Proto-Sound 3.0 Steam Engines Feature:

- Die-cast metal boiler and chassis
- Flywheel-equipped motor
- Synchronized puffing Proto-Smoke™
- Operating headlight
- All-metal wheels and gears
- Proto-Sound 3.0 engines feature sound and control system with speed control and crystal-clear digital sounds that include whistle, bell, steam chuff, Passenger or Freight Station Proto-Effects™, crew conversations, and atmospheric sounds
- Loco-Sound engines feature speed control and digital sounds that include whistle, bell, and steam chuff
- Remotely controlled Proto-Coupler™ on tender (not featured on Standard Gauge or Loco-Sound locomotives)

O Gauge RailKing Diesel Set and Locomotive Features:

- Intricately detailed, durable ABS body
- Metal frame
- Die-cast metal pilots and trucks
- Twin flywheel-equipped motors
- Operating headlight
- All-metal wheels and gears
- 2 remotely controlled Proto-Couplers™
- Proto-Sound 3.0 sound and control system featuring locomotive speed control and crystal-clear digital sounds that include horn, bell, diesel motor, Passenger or Freight Station Proto-Effects™, crew conversations, and atmospheric sounds.
- ProtoSmoke diesel exhaust in RailKing Imperial ES44AC and SD70AC diesels



Pennsylvania Merchandiser

2-8-0 Steam Freight Set



Pennsylvania Merchandiser
2-8-0 Steam Freight R-T-R Train Set
30-4226-1 Proto-Sound 3.0 \$429.95

In its heyday, the Pennsylvania Railroad was one of the largest transportation systems the world had ever seen. Over its 30,000 miles of track roamed thousands of locomotives and tens of thousands of cars, most of them designed by the railroad itself and many of them built in the road's own shops in Altoona, PA. Its conquest of the Appalachian Mountains at Horseshoe Curve, just west of Altoona, was and still is a landmark of railroad engineering, carrying freight and passengers between the East and the Midwest.

Relive the glory days of the "Standard Railroad of the World" with this rugged, hard-working freight set. With its huge plumes of puffing smoke, deep chuffing sound, and wailing whistle, it's easy to imagine you're battling your way west across Horseshoe Curve to deliver the goods to Chicago or St. Louis. For even more fun, add extra cars decorated for the Pennsylvania and other railroads — this heavy, die-cast steam locomotive has plenty of power to pull them!



**INCLUDES
TRACK AND
TRANSFORMER!**



Pennsylvania - Flat Car with 40' Trailer
30-76665 \$64.95



Pennsylvania - Tank Car
30-73475 \$59.95



Union Pacific Overland Flyer

2-8-0 Steam Freight Set



Union Pacific Overland Flyer

2-8-0 Steam Freight R-T-R Train Set

30-4228-1 Proto-Sound 3.0 \$429.95

30-4228-0 Loco-Sound \$359.95

On May 10, 1869, the Union Pacific and Central Pacific railroads met at Promontory Point, Utah to complete the first transcontinental railroad. Wagon trains and clipper ships were no longer the only way to the West Coast.

More than a century later, the Central Pacific is gone but the Union Pacific is the largest railroad in North America, with more than 8,000 locomotives, 100,000 freight cars, and 32,000 miles of track in 23 states. Due to shared motive power agreements with other railroads, its famous Armour Yellow diesels can be spotted anywhere from Los Angeles to Boston. Proud of its long history, the UP also operates a Heritage Fleet of locomotives that includes Challenger No. 3985, the world's largest operating steam locomotive — soon to be joined by an even larger UP Big Boy that is currently under restoration.

Recreate the excitement of steam era railroading in the American West with this Union Pacific freight set that includes a rugged 2-8-0 steam locomotive with puffing smoke synchronized to the drive wheel revolutions; Proto-Speed Control for smooth and steady speeds from a crawl to full throttle; traction tires for tremendous pulling power; headlight to light up the night; and a full range of sounds from wailing whistle and clanging bell to squealing brakes and crew conversations.*

*only in Proto-Sound 3.0 models



**INCLUDES
TRACK AND
TRANSFORMER!**



Union Pacific - Flat Car with 40' Trailer

30-76664 \$64.95



Union Pacific - Tank Car

30-73476 \$59.95



2-8-0 Steam Engine



Chessie - 2-8-0 Steam Engine
33-1043-1 Proto-Sound 3.0 \$299.95

The 2-8-0 steam engine was first developed in 1864-1865 to provide power for heavy trains running at moderate speeds, especially on steep grades. Alexander Mitchell, the chief mechanic for the Lehigh and Maloney Railroad, an eastern Pennsylvania coal hauler, designed the original

2-8-0. The Pennsylvania Railroad (PRR) was the first to put the 2-8-0 type engine on the rails when they rebuilt a Baldwin flexible-beam engine to a 2-8-0 configuration. For more than forty years, the 2-8-0 Consolidation was America's standard freight locomotive, working hard on virtually every railroad.



New York Central - 2-8-0 Steam Engine
33-1042-1 Proto-Sound 3.0 \$299.95



Pittsburgh & Lake Erie - 2-8-0 Steam Engine
33-1044-1 Proto-Sound 3.0 \$299.95

Features:

- Die-Cast Boiler and Chassis
- Durable ABS Tender Body
- Metal Wheels and Axles
- Die-Cast Tender Truck Sides
- Precision Flywheel-Equipped Motor
- Metal Handrails, Bell and Whistle
- Constant Voltage Headlight
- Remote Controlled Proto-Coupler
- Synchronized Puffing ProtoSmoke System
- Locomotive Speed Control In Scale MPH Increments
- Wireless Drawbar
- Proto-Sound 3.0 With The Digital Command System Featuring Freight Yard Proto-Effects
- Unit Measures: 19 1/4" x 2 1/2" x 3 3/4"
- Operates on O-27 Curves

EMD SD70ACe Diesel



IMPERIAL
SERIES



Conrail (NS Heritage) - Bay Window Caboose
30-77298 \$64.95

Reading (NS Heritage) - Gondola Car with Crates
30-72176 \$59.95

Build Your Own Heritage Set - All Components Sold Separately



New York Central - Bay Window Caboose
30-77300 \$64.95

New York Central - Gondola Car with Crates
30-72178 \$59.95



Norfolk Southern - Flat Car with 40' Trailer
30-76660 \$64.95



Norfolk Southern - Flat Car
with Bulkheads & Lumber Load
30-76650 \$59.95



Norfolk Southern - Modern Tank Car
30-73485 \$54.95

Norfolk Southern - SD70ACe Diesel
30-20367-1 Proto-Sound 3.0 \$339.95



New York Central - Modern Tank Car
30-73487 \$54.95

New York Central - SD70ACe Diesel
30-20369-1 Proto-Sound 3.0 \$339.95



New York Central - Flat Car with 40' Trailer
30-76662 \$64.95



New York Central - Flat Car with Bulkheads
& Lumber Load
30-76652 \$59.95

EMD SD70ACe Diesel



Chicago & North Western - Bay Window Caboose
30-77301 \$64.95

Chicago & North Western - Gondola Car
with Crates
30-72179 \$59.95

Build Your Own Heritage Set - All Components Sold Separately



Missouri Pacific (UP Heritage) - Bay Window Caboose
30-77299 \$64.95

Denver Rio Grande (UP Heritage) - Gondola
Car with Crates
30-72177 \$59.95



Chicago & North Western - Flat Car
with Bulkheads & Lumber Load
30-76653 \$59.95



Chicago & North Western - Flat Car with
40' Trailer
30-76663 \$64.95



Chicago & North Western - Modern Tank Car
30-73488 \$54.95

Chicago & North Western - SD70Ac Diesel
30-20370-1 Proto-Sound 3.0 \$339.95



Southern Pacific (UP Heritage) - Modern Tank Car
30-73486 \$54.95

Union Pacific - SD70Ac Diesel
30-20368-1 Proto-Sound 3.0 \$339.95



Union Pacific - Flat Car with Bulkheads & Lumber Load
30-76651 \$59.95



Union Pacific - Flat Car with 40' Trailer
30-76661 \$64.95

General Electric ES44AC Diesel



Southern - Bay Window Caboose
30-77294 \$64.95

Southern - Gondola Car with Crates
30-72172 \$59.95

Build Your Own Heritage Set - All Components Sold Separately



Long Island - Bay Window Caboose
30-77295 \$64.95

Long Island - Gondola Car with Crates
30-72173 \$59.95



Southern - Flat Car with 40' Trailer
30-76659 \$64.95



Southern - Flat Car with Bulkheads &
Lumber Load
30-76649 \$59.95



Southern - Modern Tank Car
30-73481 \$54.95

Southern - ES44AC Diesel
30-20363-1 Proto-Sound 3.0 \$339.95



Long Island - Modern Tank Car
30-73482 \$54.95

Long Island - ES44AC Diesel
30-20364-1 Proto-Sound 3.0 \$339.95



Long Island - Flat Car with 40' Trailer
30-76656 \$64.95



Long Island - Flat Car with
Bulkheads & Lumber Load
30-76646 \$59.95

General Electric ES44AC Diesel



Chesie (CSX Heritage) - Bay Window Caboose
30-77297 \$64.95

Western Maryland (CSX Heritage) - Gondola
with Crates
30-72175 \$59.95

Build Your Own Heritage Set - All Components Sold Separately



Burlington Northern (BNSF Heritage) - Bay
Window Caboose
30-77296 \$64.95

Burlington (BNSF Heritage) - Gondola Car
with Crates
30-72174 \$59.95



CSX - Flat Car with Bulkheads & Lumber Load
30-76648 \$59.95



CSX - Flat Car with 40' Trailer
30-76658 \$64.95



Seaboard Coast Line (CSX Heritage) -
Modern Tank Car
30-73484 \$54.95

CSX - ES44AC Diesel
30-20366-1 Proto-Sound 3.0 \$339.95



Great Northern Oil (BNSF Heritage) -
Modern Tank Car
30-73483 \$54.95

BNSF - ES44AC Diesel
30-20365-1 Proto-Sound 3.0 \$339.95



BNSF - Flat Car with
Bulkheads & Lumber Load
30-76647 \$59.95



BNSF - Flat Car with 40' Trailer
30-76657 \$64.95

Imperial Diesel & Caboose Set



Norfolk Southern (Veterans) -
SD70ACe Imperial Diesel & Caboose Set
30-20362-1 Proto-Sound 3.0 \$399.95



Norfolk Southern (First Responders) -
SD70ACe Imperial Diesel & Caboose Set
30-20361-1 Proto-Sound 3.0 \$399.95



Christmas - ES44AC Imperial Diesel
& Caboose Set
30-20360-1 Proto-Sound 3.0 \$399.95

**Red Flashing
Charging Lights!**



Halloween - ES44AC Imperial Diesel & Caboose Set
30-20359-1 Proto-Sound 3.0 \$399.95





Model the ground-shaking, high horsepower drama of modern railroading with General Electric's Evolution Series ES44AC and EMD's SD70ACe locomotive and caboose sets, each adorned in holiday paint schemes or Norfolk Southern honor schemes celebrating veterans and first responders.

GE claims the EVOs are "the most fuel-efficient, most environmentally friendly diesel locomotives in history... If every freight train in North America were pulled by an Evolution Series Locomotive, the reduction of smog-producing pollutants would be like removing 48 million cars from the road each year."

The SD70ACe is Electro-Motive Diesel's hope for the future not only as an environmentally friendly replacement for EMD's SD70MAC but also to recapture the lead in North American locomotive sales that EMD lost to General Electric in 1987.

Our superbly detailed, top-of-the-line RailKing Imperial models of these modern freight movers feature a full range of locomotive sounds recorded from an actual ES44AC and SD70ACe. Outfitted with two powerful flywheel-equipped motors, all-metal wheels and gears, and our revolutionary Proto-Speed Control, our Imperial diesels will haul long freights at any speed from a crawl to full throttle. Remotely activated front and rear Proto-Couplers allow you to pick up and drop off freight wherever you like. Additional Imperial features on either locomotive include operating diesel exhaust smoke and flashing ditch lights.



**Add a Matching Flat Car with 40' Trailer!
See Page 28**

Orange Flashing Charging Lights!

Imperial ES44AC and SD70ACe Features:

- Intricately Detailed Durable ABS Body
- Die-Cast Truck Sides, Pilots and Fuel Tank
- Metal Chassis, Handrails and Horn
- (2) Handpainted Engineer Cab Figures
- Metal Wheels, Axles and Gears
- (2) Remote Controlled Proto-Couplers
- Directionally Controlled Constant Voltage LED Headlights
- LED-Illuminated Number Boards and Cab Interior Light
- Flashing LED Ditch Lights
- Flashing LED Chase Lights (ES44 only)
- (2) Precision Flywheel-Equipped Motors
- Operating ProtoSmoke Diesel Exhaust
- Locomotive Speed Control In Scale MPH Increments
- Near-Scale Sizing
- Proto-Sound 3.0 With The Digital Command System Featuring Freight Yard Proto-Effects
- Measures: 17" x 2 1/2" x 3 3/4"
- Operates On 0-31 Curves

EMD F3 Diesel



Santa Fe - 60' Streamlined Observation
30-67910 \$74.95

Santa Fe - 60' Streamlined Vista Dome Car
30-67909 \$74.95

Build Your Own Set - All Components Sold Separately



Pennsylvania - 60' Streamlined Observation
30-67913 \$74.95

Pennsylvania - 60' Streamlined Vista Dome Car
30-67912 \$74.95



Texas Special - 60' Streamlined Observation
30-67916 \$74.95

Texas Special - 60' Streamlined Vista Dome Car
30-67915 \$74.95



Santa Fe - 60' Streamlined Baggage Car
30-67908 \$74.95

Santa Fe Chief - Scale F-3 Diesel
30-20371-1 Proto-Sound 3.0 \$329.95

See Next Page For Additional Cars



Car Pennsylvania - 60' Streamlined Baggage Car
30-67911 \$74.95

Pennsylvania Liberty Limited - Scale F-3 Diesel
30-20372-1 Proto-Sound 3.0 \$329.95



Car Texas Special - 60' Streamlined Baggage Car
30-67914 \$74.95

Texas Special - Scale F-3 Diesel
30-20373-1 Proto-Sound 3.0 \$329.95

Add-On Passenger Cars



Santa Fe - 60' Streamlined Coach
30-67900 \$74.95



Santa Fe - 60' Streamlined Full-Length
Vista Dome
30-67901 \$79.95



Santa Fe - 2-Car 60' Streamlined Sleeper/Diner
30-67899 \$149.95



Pennsylvania - 60' Streamlined Coach
30-67903 \$74.95



Pennsylvania - 60' Streamlined
Full-Length Vista Dome
30-67904 \$79.95



Pennsylvania - 2-Car 60' Streamlined Sleeper/Diner
30-67902 \$149.95



Texas Special - 60' Streamlined Coach
30-67906 \$74.95



Texas Special - 60' Streamlined Full-Length
Vista Dome
30-67907 \$79.95



Texas Special - 2-Car 60' Streamlined Sleeper/Diner
30-67905 \$149.95

Bump-n-Go Trolley

This colorful trolley features a lighted interior, metal wheels and gears, and a long-lasting motor. It operates on any O Gauge track system including the easy-to-assemble RealTrax® system. Optional track bumpers can be added to take advantage of the Automatic Bump-Reverse Mechanism (ABRM) that changes the trolley's direction when it hits a track bumper.

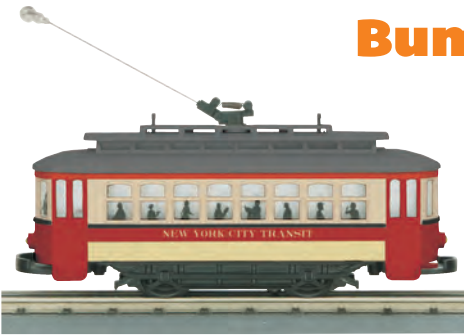

New York Transit - Bump-n-Go Trolley
30-5139 \$79.95

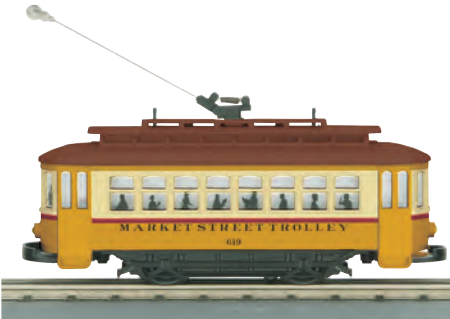

Market Street - Bump-n-Go Trolley
30-5141 \$79.95

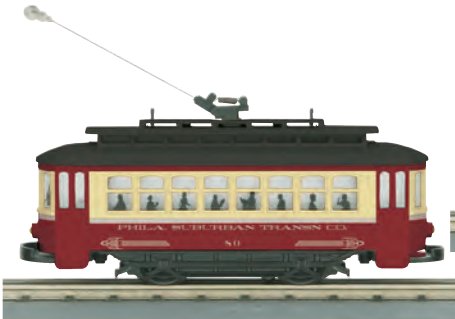

Philadelphia - Bump-n-Go Trolley
30-5143 \$79.95

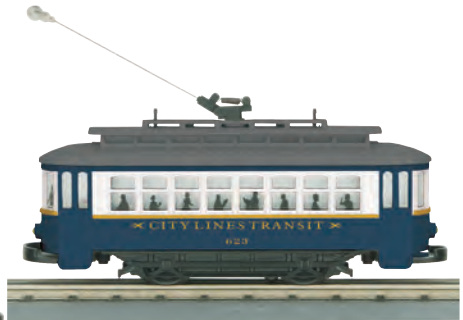

City Lines - Bump-n-Go Trolley
30-5140 \$79.95

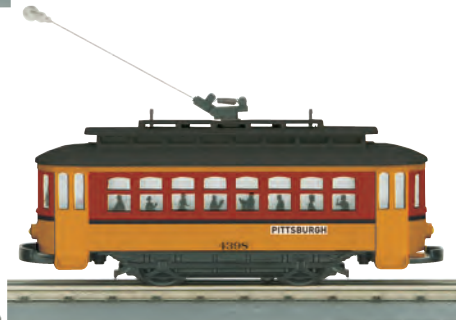

Pittsburgh - Bump-n-Go Trolley
30-5142 \$79.95

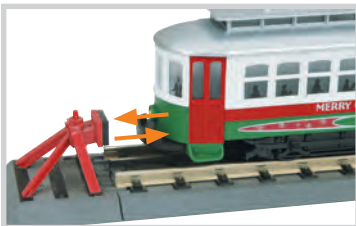

Trolley automatically reverses when it hits a bumper.



Christmas - Bump-n-Go Trolley
30-5146 \$79.95

No. 342E Outfit Passenger Set



Std.
gauge

Lionel Lines - No. 342E Outfit
Std. Gauge Passenger Set
11-5012-1 Proto-Sound 3.0 \$599.95



Lionel Lines - No. 309
Coach Passenger Car
11-40074 \$139.95



Lionel Lines - No. 310
Baggage Passenger Car
11-40073 \$139.95





One of Lionel's most popular lower-priced outfits, the 342E Standard Gauge passenger set came highly enameled in Duo-Tone colors. The set included the 318E Distant Control locomotive, plus a train of illuminated Pullman cars with simulated stained glass panels above each window. Bringing up the rear was an observation car with a brass-trimmed open-air platform, where toy passengers could presumably step outside, smoke an expensive Cuban cigar, and watch the world recede behind the train.

Our recreation of this tinplate classic comes decorated in Lionel's iconic blue and orange color scheme and lettered for the fictional Lionel Lines. Car names commemorate locations of historic Lionel facilities. And thanks to Proto-Sound 3.0,



the set's 318E locomotive features a blaring horn, clanging bell, passenger station announcements, and Proto-Speed control for smooth, steady operation at any speed from a crawl to full throttle.



Operating Box Car with Signal Man



RailKing operating freight cars add a new dimension and excitement level to your O Gauge layout, with realistic action and quiet, smooth operation.

This car comes to life when parked on an operating track section. When the track section is activated, the car door opens and the signal man emerges with his lantern lit. Then he goes back into the car and the door closes until he's needed again.



Alaska - Operating Box Car with Signal Man
30-79514 \$89.95



Norfolk Southern - Operating Box Car with Signal Man
30-79515 \$89.95



Boston & Maine - Operating Box Car with Signal Man
30-79516 \$89.95



Western Maryland - Operating Box Car with Signal Man
30-79517 \$89.95

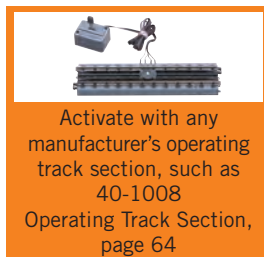



Operating Hand Car



Pennsylvania - Operating Hand Car
30-2574 \$69.95

Figures pump
up and down
as car moves
along the track



Christmas - Operating Hand Car
30-2573 \$69.95



Maintenance Of Way - Operating Hand Car
30-2526 \$69.95



Maintenance Of Way (Orange) -
Operating Hand Car
30-2547 \$69.95

Smoking Tank Car



This whimsical car features an operating smoke unit inside the tank that wafts smoke out of the tank filler cap. Operates on any O Gauge track with any transformer, with smoke controlled by an on/off switch.

NASA - Smoking Tank Car
30-73473 \$79.95



Air Products - Smoking Tank Car
30-73474 \$79.95

Flat Car with 40' Trailer



Christmas - Flat Car with 40' Trailer
30-76654 \$64.95

Great
Complement
For Your
SD70ACe Diesel
& Caboose Set
See Page 18-19



Halloween - Flat Car with 40' Trailer
30-76655 \$64.95



Operating Action Car



This exciting car features a backlit, moving animation strip visible through each of the car's four large viewing windows. Utilizing a quiet and efficient motor and bright LED lighting, the animated action really shines bright!

CSX - Operating Action Car
30-79512 \$79.95



Ducks - Operating Action Car
30-79511 \$79.95



Features bright,
backlit moving scenes

BNSF - Operating Action Car
30-79513 \$79.95



G.E. Evolution - Operating Action Car
30-79510 \$79.95

50' Double Door Plugged Box Car

While usually referred to as an insulated boxcar, the prototype for this car, according to the Association of American Railroads (AAR), is technically a bunkerless refrigerator car, class RBL. Built by Evans Products Company at Blue Island, Illinois from 1969-1977, these cars were designed for shipments that need protection from temperature extremes but do not require refrigeration. They have hardwood floors and at least 3" of insulation in their sides, ends and roofs. Produce is a common cargo. The cars' length and wide 16' door openings have also made them popular with plywood and lumber shippers.

In contrast with typical sliding doors, the plug doors on these cars are pulled into the door opening when the door is latched. This produces a nearly watertight and airtight seal, protecting the load and helping to keep a more constant inside temperature. A cushioned underframe also helps protect the load from shock, hence the "DF" (for "damage free") logo found on some of these cars.

Evans Products built nearly 4,400 of these cars, selling or leasing them to a large number of North American railroads and private owners. Although the last of these cars are nearing the end of their allowable 40-year service life, they can still be found in U.S. freight trains today.

Like all RailKing freight cars, these box cars feature die-cast metal trucks and couplers, metal wheels and axles, and durable, intricately detailed ABS plastic bodies built for a lifetime of model railroading.



TTX - 50' Double Door Plugged Box Car
30-74850 \$54.95



Conrail - 50' Double Door Plugged Box Car
30-74851 \$54.95



Illinois Central - 50' Double Door Plugged Box Car
30-74852 \$54.95



CP Rail - 50' Double Door Plugged Box Car
30-74853 \$54.95

Box Car with Blinking LEDs



Pittsburgh & Lake Erie - Box Car with Blinking LEDs
30-74856 \$79.95

This 40' box car features bright, flashing LEDs on both sides of the car, illuminating a railroad crossbuck and touting one of railroading's most important safety messages. Each LED flashes alternately, just like a real railroad crossing signal, and is sure to grab the attention of visitors to your layout. Like all RailKing freight cars, this model is completely assembled and ready-to-run — just put it on the track and enjoy the action!



Alaska - Box Car with Blinking LEDs
30-74855 \$79.95



Chessie - Box Car with Blinking LEDs
30-74857 \$79.95

**Flashing
Crossbuck!**



Norfolk Southern - First Responders Box Car with Blinking LEDs
30-74854 \$79.95

40' High-Cube Box Car

With an interior height of about 13 feet — 2 feet more than a standard box car — this car is known as a “hi-roof” or “high cube” car for its high cubic capacity. White end panels make railroad crews aware of its extra height, which prevents it from traveling in some areas.

These cars are particularly favored by the modern printing industry, which uses large rolls of paper too big for standard box cars. Side-to-floor joints and doorframes are reinforced to accommodate the heavy weight of paper rolls. Longer 60' versions of this design are widely used for transporting parts for car manufacturing.

Like all RailKing freight cars, these box cars feature die-cast metal trucks and couplers, metal wheels and axles, and durable, intricately detailed ABS plastic bodies built for a lifetime of model railroading.



CSX - 40' High Cube Box Car
30-74846 \$54.95



Duluth Missabe & Iron Range - 40' High Cube Box Car
30-74848 \$54.95



Indiana Rail Road - 40' High Cube Box Car
30-74849 \$54.95



Buffalo & Pittsburgh -
40' High Cube Box Car
30-74847 \$54.95

40' Box Car



Christmas - Box Car
30-74843 \$59.95



Happy Holidays - Box Car
30-74842 \$59.95



Happy New Year - Box Car
30-74844 \$59.95



Happy Halloween - Box Car
30-74845 \$59.95



Christmas (2014) - Box Car
30-74779 \$59.95

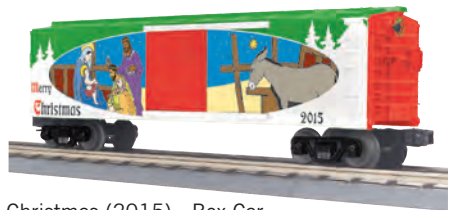

Christmas (2015) - Box Car
30-74823 \$59.95



Happy Holidays (2014) - Box Car
30-74780 \$59.95



Happy Holidays (2015) - Box Car
30-74824 \$59.95

4-Bay Hopper

Unlike equipment that carried a variety of loads, like boxcars, flatcars, and gondolas, this four-bay hopper was designed specifically for one cargo: bituminous coal. Its capacity matched the volume of coal that a pair of typical 70-ton freight trucks could carry. And its slope sheets — the angled floors at either end of the car — were set at precisely the angle at which coal would flow easily from its bottom doors. (Covered grain hoppers, for example, require much steeper slope sheets.)

The large four-bay car was ideal for delivery of bituminous coal to large industrial customers and railroads. In contrast, cleaner-burning anthracite coal, shipped more commonly to small, local coal dealers who served the home heating market, often traveled in smaller two-bay hoppers.

High quality, traditionally sized RailKing Freight Cars provide detailed bodies and colorful paint schemes for the O Gauge railroader. MTH makes an enormous variety of RailKing Freight Cars, including many different car types and roadnames. No matter what era or part of the country you are modeling, RailKing is sure to have something for you.



CSX - 4-Bay Hopper
30-75554 \$54.95



BNSF - 4-Bay Hopper
30-75555 \$54.95

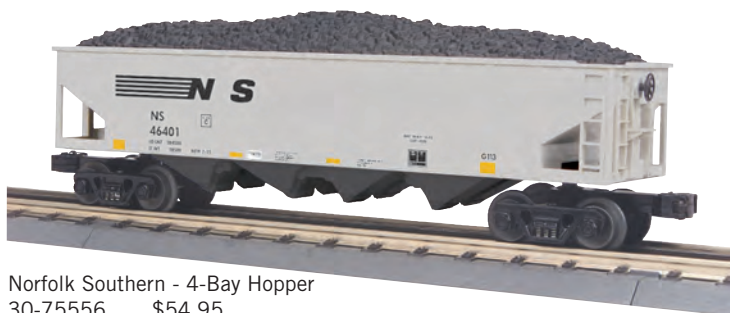

Norfolk Southern - 4-Bay Hopper
30-75556 \$54.95



Union Pacific - 4-Bay Hopper
30-75557 \$54.95

Tank Car



Gulf - Tank Car
30-73477 \$59.95



New York Central - Tank Car
30-73478 \$59.95



Baltimore & Ohio - Tank Car
30-73479 \$59.95

Chicago and North Western -
Tank Car
30-73480 \$59.95



The tank car was relatively uncommon until the 1870s, when the nascent petroleum industry ordered large quantities of metal tanks carried on wooden car bodies. By the early 1900s, a standard design had evolved that lasted throughout the steam and early diesel eras: an 8,000-11,000 gallon metal tank perched on a metal flatcar-like underframe.

The one big change during that time was the transition from riveted to welded construction, beginning in the late 1930s. Car builders introduced X-ray inspection of welds to ensure safety, as well as giant annealing ovens that could heat-treat assembled tanks to relieve joint stress. Welded tanks were stronger, less susceptible to rust and corrosion, and less likely to rupture in the event of a wreck.

Our model represents a typical all-welded, insulated tank car built in the late 1940s or 1950s. A layer of insulation protected cargos that were sensitive to temperature extremes, and some such cars also had heating coils under their outer layer. Our model also features a safety platform around the dome — insulation and safety platforms being features commonly found on cars used in the chemical industry. Featuring 1:48 scale dimensions, a detailed tank body, die cast underframe, metal handrails, and safety platform with see-through grating, this RailKing model also mixes well with scale-dimensioned Premier freight cars.

4-Car O-27 Madison Passenger

Add passenger service to your railroad with these detailed models of the heavyweight passenger cars that served travelers coast to coast for most of the twentieth century. Each car features die-cast metal trucks and couplers as well as a lighted interior (except baggage cars), and will operate on any 3-rail O Gauge track, including the tightest O-27 curves.



Long Island - 4-Car O-27 Madison Passenger Set
33-6261 \$219.95



Chessie - 4-Car O-27 Madison Passenger Set
33-6263 \$219.95



New York Central - 4-Car O-27 Madison Passenger Set
33-6262 \$219.95



Union Pacific - 4-Car O-27 Madison Passenger Set
33-6264 \$219.95

Sets

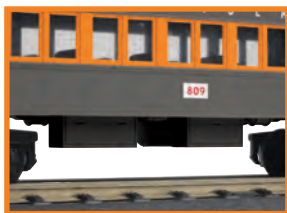

Detailed,
Illuminated
Interiors



Accessorize Your Layout!



See it in Action!

When you see this  icon, search for the item number on www.mthtrains.com to see a video of the item in action!

Create a miniature world for your railroad to serve with this wide variety of lighted RailTown™ buildings, operating accessories and O scale passengers and workers.



■ Maintenance Kit
30-50051 \$24.95



**Keep your
Trains Running
Their Best**

■ Track Cleaning Block
40-1099 \$24.95



■ 7 oz. ProtoSmoke™ Fluid		
60-1045	Unscented	\$15.95
60-1046	Christmas	\$15.95
60-1047	Coal	\$15.95
60-1048	Diesel	\$15.95
60-1049	Woodburning	\$15.95

Assortment (36 pieces)
2 oz. ProtoSmoke™ Fluid Bottles
60-1051 \$189.95

2 oz. ProtoSmoke™ Fluid Bottles		
60-1051A	Christmas	\$5.29
60-1051B	Coal	\$5.29
60-1051C	Diesel	\$5.29
60-1051D	Wood Burning (Hickory)	\$5.29
60-1051E	Coffee	\$5.29
60-1051G	Vanilla	\$5.29
60-1051H	Candy Cane	\$5.29
60-1051I	Barbeque	\$5.29
60-1051J	Pipe Smoke	\$5.29
60-1051K	Cinnamon Roll	\$5.29
60-1051L	Apple Pie	\$5.29
60-1051M	Unscented	\$5.29
60-1051N	Lemon	\$5.29



■ Operating Cooling Tower
30-9158 \$169.95
Measures: 9 1/2" x 8" x 12"

■ Rotary Beacon
30-9033 \$59.95
Measures:
5" x 5" x 11 1/4"



Features
Flashing
Rooftop
Beacon!

■ M.T.H. Electric Trains -
#193 Industrial Water Tower
30-90415 \$69.95
Measures: 6" x 6" x 14 3/4"

■ Yellow - #395 Floodlight Tower
30-9025 \$59.95
Measures: 5" x 5" x 11 1/4"



Operating pickup
and dump
mechanism
for loading
coal hoppers



All Metal
Construction!

■ 314 Die-Cast Girder Bridge
30-12011 \$34.95
Measures: 10" x 4 1/2" x 1 3/4"



- Miscellaneous Accessories
- Traditional Accessories
- O Scale Accessories

O Scale accessories are realistic O scale models, 1/48 of the actual item's size, while Traditional accessories are more toy-like in appearance and proportions.

Accessories



■ 2-Piece Crate Set
30-50027 \$14.95



■ 2-Piece Cement LCL Container Set
30-50029 \$14.95



■ 2-Piece Generator Set
30-50028 \$12.95



■ 6-Piece Barrel Set
30-50024 \$11.95

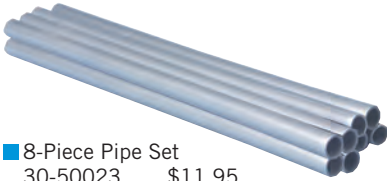

■ 8-Piece Pipe Set
30-50023 \$11.95
Measures: 10" Long



■ 8-Piece Log Set
30-50008 \$14.95
Measures: 5" Long



■ MTH Steel - I-Beam 8-Piece Set
30-50007 \$12.95
Measures: 7 1/4" Long



■ White - Fence Set
30-50002 \$12.95
Measures: 16" x 13"
House Not Included



■ Hi-Tension Tower Set
30-1056 \$79.95
Measures: 20" x 6 3/8" x 6 3/8"



■ Black - "O" Lamp Set - Hexagonal
30-1062 \$34.95
Measures: 4" Tall



■ Black - "O" Lamp Set - Square
30-1079 \$34.95
Measures: 4" Tall



■ Black - "O" Lamp Set - Round
30-1078 \$34.95
Measures: 4" Tall



■ "O" Lamp Set -
Gooseneck Street Light
30-11032 \$34.95
Measures: 3/4" x 3 7/8"



■ O Scale Floodlight Tower Set
30-11039 \$89.95
Measures: 3" x 1 1/8" x 13 1/2"

■ "O" Lamp Set - Gas Street Light
30-11033 \$34.95
Measures: 3/4" x 4 3/8"



■ "O" Lamp Set - Triple Park Light
30-11034 \$34.95
Measures: 3/4" x 4 7/16"

Accessories



■ O Scale Vertical Signal
30-11036 \$59.95
Measures: 1 3/16" x 2 5/8" x 7 1/8"



■ "O" Operating Crossing Flasher Set w/Sound
30-11014 \$69.95
Measures: 5 1/2" x 2 1/2" x 1"

Have your trains activate these signals with a RealTrax® ITAD (p. 67) or ScaleTrax™ ITAD (p. 77)



■ O Scale Water Column
30-11007 \$29.95
Measures: 6" Tall

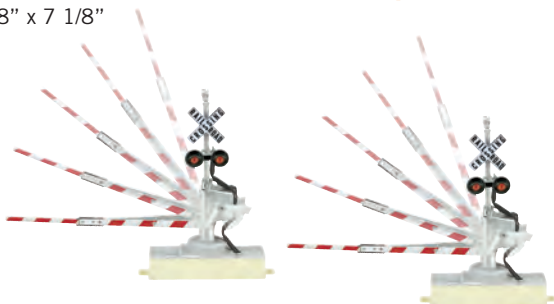

■ O Scale Operating Crossing Gate Signal Set
30-11012 \$79.95
Measures: 8 1/2" x 2" x 8"



■ Road Sign Set (2 Each)
30-1087 \$14.95
Measures: 2" Tall

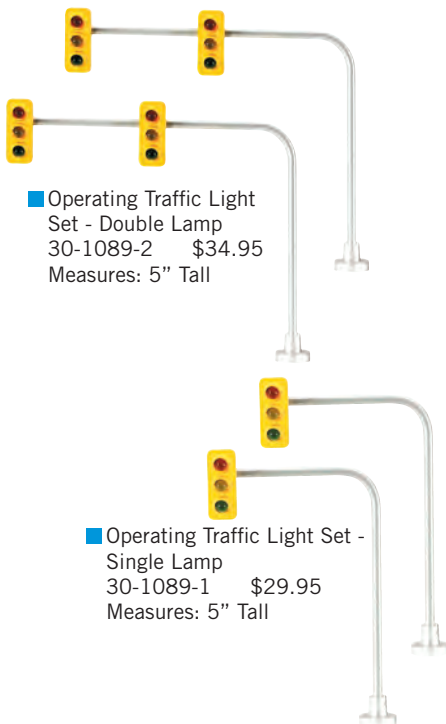

■ Operating Traffic Light Set - Double Lamp
30-1089-2 \$34.95
Measures: 5" Tall

■ Operating Traffic Light Set - Single Lamp
30-1089-1 \$29.95
Measures: 5" Tall



■ Telephone Pole Set
30-1088 \$19.95
Measures: 5 3/4" Tall



Have your trains activate these signals with a **RealTrax® ITAD** (p. 67) or **ScaleTrax™ ITAD** (p. 77)

- O Scale 3-Position Semaphore
30-11023 \$59.95
Measures: 7" Tall



- O Scale Flashing Barricades
30-11021 \$34.95
Measures: 1" x 1" x 2"

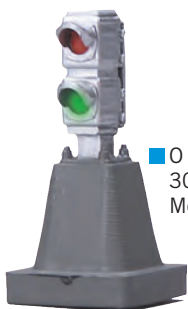

- O Scale Modern Dwarf Signal
30-11038 \$39.95
Measures: 1 1/2" x 1" x 2 1/8"

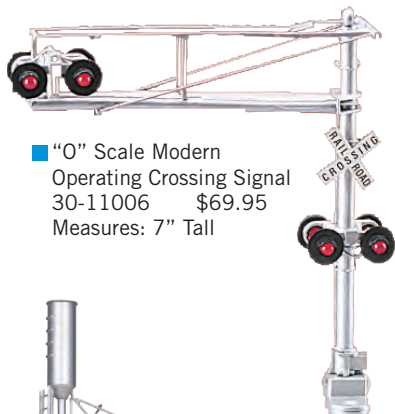

- "O" Scale Modern Operating Crossing Signal
30-11006 \$69.95
Measures: 7" Tall



- Sanding Tower
30-11040 \$39.95
Measures: 1 3/16" x 1 1/4" x 10 3/8"

Indicates switch position when used with **ScaleTrax**, **Atlas O** or **Gargraves** switches

Atlas O is a registered trademark of Atlas O; GarGraves is a registered trademark of GarGraves Trackage Corporation.

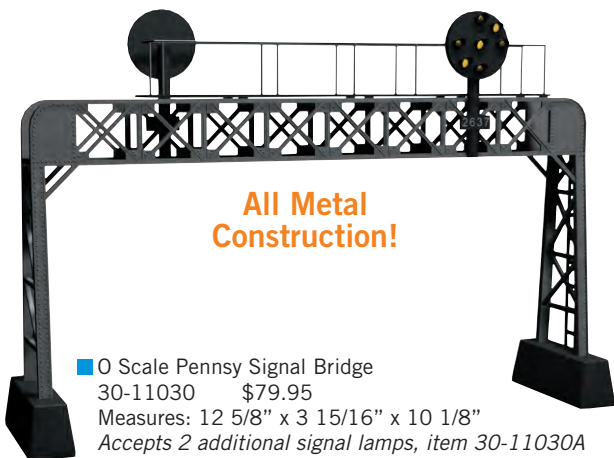

All Metal Construction!

- O Scale Pennsy Signal Bridge
30-11030 \$79.95
Measures: 12 5/8" x 3 15/16" x 10 1/8"
Accepts 2 additional signal lamps, item 30-11030A



- O Scale Position Light Signal Lamps
30-11030-A \$19.95
Measures: 1 1/4" Tall
(package of 2; fits 30-11030 Pennsy Signal Bridge)

Have your trains activate signal lamps with **RealTrax ITADs** (p. 67) or **ScaleTrax ITADs** (p. 77)

Accessories



- Greyhound (Concord) - Die-Cast Bus
30-50105 \$44.95
All Buses Measure: 8" x 1 15/16" x 2 1/8"



- Boston & Maine - Die-Cast Bus
30-50069 \$44.95



- Pittsburgh & Lake Erie - Die-Cast Bus
30-50106 \$44.95

Great Accessories for Bus Station, Page 56



- Alaska - Die-Cast Bus
30-50068 \$44.95



- Greyhound (Lexington) - Die-Cast Bus
30-50104 \$44.95



- Boston & Maine - Die-Cast Bus
30-50107 \$44.95

Die-Cast Metal!



- Philadelphia Fire Department - Die-Cast Fire Truck
30-50101 \$49.95



- Cleveland Union Terminal - Die-Cast Fire Truck
30-50103 \$49.95

- Braddock, Pennsylvania - Die-Cast Fire Truck
30-50100 \$49.95

All Fire Trucks Measure: 6 1/4" x 2 1/8" x 1 7/8"



- NYC Fire Department - Die-Cast Fire Truck
30-50102 \$49.95



- Billy Ray's Barbeque - Vendor Trailer
30-50071 \$39.95
Measures: 10" Long



- Roscoe's Fireworks - Vendor Trailer
30-50072 \$39.95
Measures: 10" Long

Opening Side Doors with Lighted Interior!



■ 4-Pack Motorcycle Set #1
30-11084 \$27.95
Measures: 2" Long x 1" High

Die-Cast Metal!

■ 4-Pack Motorcycle Set #2
30-11085 \$27.95
Measures: 2" Long x 1" High



■ Miller High Life - Lighted Billboard
30-90496 \$34.95
Measures: 7 1/2" x 5 3/4" x 6"

©2016 MillerCoors, LLC. All rights reserved.
Produced under license by M.T.H. Electric Trains.
This licensed product is intended for adults of legal drinking age.



■ Jahn's Ice Cream - Lighted Billboard
30-90495 \$34.95
Measures: 7 1/2" x 5 3/4" x 6"



■ Horlacher's Brewing Company - Lighted Billboard
30-90479 \$34.95
Measures: 7 1/2" x 5 3/4" x 6"



Operating Lamps!

■ Flushing-Main Street / Roosevelt Avenue - Subway Entrance
30-90467 29.95
Measures: 3 5/8" x 1 3/4" x 2"



■ Vernon Boulevard-Jackson Avenue - Subway Entrance
30-90468 29.95
Measures: 3 5/8" x 1 3/4" x 2"

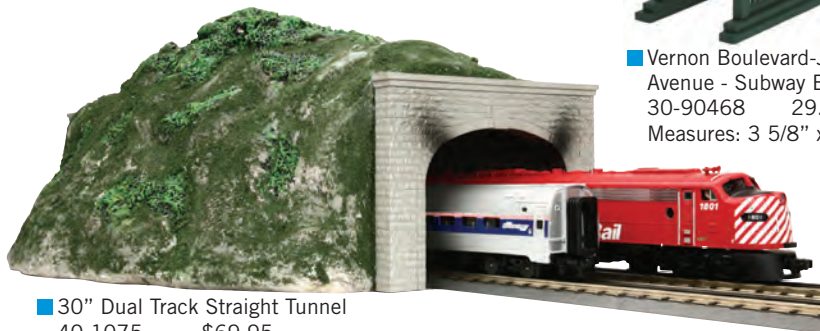

■ 30" Dual Track Straight Tunnel
40-1075 \$69.95
Measures: 30 1/2" x 22" x 11 1/2"

Figures



■ Passenger #4 - 12-Piece Passenger Figure Set
30-11068 \$29.95



■ Assortment 1 - 6-Piece Figure Set
30-11071 \$19.95



■ Assortment 1 - 6-Piece Figure Set #12
30-11074 \$19.95



■ Assortment 2 - 6-Piece Figure Set
30-11072 \$19.95



■ Fire House Employees - 6-Piece Figure Set #2
30-11046 \$19.95



■ Gas Station Attendants & Patron - 6-Piece Figure Set #1
30-11045 19.95



■ Bus Station Employees & Patrons - 6-Piece Figure Set #4
30-11048 19.95



■ Diner Patrons - 6-Piece Figure Set #3
30-11047 \$19.95



■ Miners - 6-Piece Figure Set #6
30-11058 \$19.95



■ Cops & Robbers - 6-Piece Figure Set #5
30-11056 \$19.95



■ Fire Scene - 6-Piece Figure Set #8
30-11060 \$19.95



■ Outdoor People - 6-Piece Figure Set
30-11057 \$19.95



■ Army - 6-Piece Figure Set #7
30-11059 \$19.95



■ Passenger #3 - 12-Piece Passenger Figure Set
30-11067 \$29.95



■ Christmas - 6-Piece Figure Set
30-11062 \$24.95



■ Passenger Figures - 12-Piece Figure Set #1
30-11016 \$29.95



■ Railroad Employees - 12-Piece Figure Set #3
30-11055 \$29.95



■ Passenger Figures - 12-Piece Figure Set #1
30-11016 \$29.95



■ Passenger Figures - 12-Piece Figure Set #2
30-11029 \$29.95



■ Workmen - 12-Piece Figure Set #3
30-11044 \$29.95



■ Subway - 12-Piece Passenger Figure Set
30-11063 \$29.95



■ 8-Piece Locomotive Cab Figure Set
30-11064 \$29.95



■ Railroad Workmen - 12-Piece Figure Set #3
30-11066 \$29.95

■ Undecorated -
120-Piece Passenger
Figure Set
30-11043 \$29.95



RailTown™ Buildings



Cars Drive Up and
Park, While Skaters
Come Out and
Take Orders



Mel's - Operating Drive-In Diner
30-9188 \$199.95
Measures: 21 5/8" x 9" 13 1/8"



Sequentially Lighted
Marquee Sign and
Interior Lighting

Majestic - Movie Theater
30-90490 \$129.95
Measures: 16 3/4" x 13 9/16" x 9 1/16"

Fireman Slides Down
Pole, Door Opens and
Fire Truck Pulls Out
With Siren Blaring



Engine Company 49 - Operating Firehouse
30-9157 \$189.95
Measures: 16 5/8" x 15 3/8" x 12 3/8"



The Old Reading Brewery Company -
Operating Freight Platform
30-90190 \$64.95
Measures: 10" x 3 1/2" x 4"



Middletown Station -
Operating Freight Platform
30-9184 \$64.95
Measures: 10" x 3 1/2" x 4"



Railtown - Operating Station Platform
30-9163 \$64.95
Measures: 10" x 3 1/2" x 4"



Military - Operating Station Platform
30-9183 \$64.95
Measures: 10" x 3 1/2" x 4"

**Tank Cover and Stairs
Rise and Fall as Tank
Fills and Empties**



Shell - Operating Storage Tank
30-9189 \$199.95
Measures: 17 5/16" x 11" x 10"

**Operating
Lights**

**Attendant With Hose
Descends to Fill
Waiting Tank Car**



Shell - Operating Storage Tank Station
30-9190 \$179.95
Measures: 16 1/8" x 5" x 8 1/8"

RailTown Buildings



Mobil - Tank Filling Station
30-90419 \$59.95
Measures: 16 1/8" x 5" x 8 1/8"

Esso - Tank Filling Station
30-90405 \$59.95
Measures: 16 1/8" x 5" x 8 1/8"

Operating
Lights



Shell - Tank Filling Station
30-90472 \$59.95
Measures: 16 1/8" x 5" x 8 1/8"

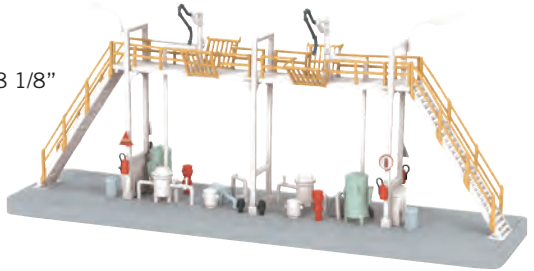

Operating
Lights



Esso - Operating Storage Tank Station
30-9178 \$179.95
Measures: 16 1/8" x 5" x 8 1/8"

Attendant With Hose
Descends to Fill
Waiting Tank Car



Sunoco - Operating Storage Tank Station
30-9179 \$179.95
Measures: 16 1/8" x 5" x 8 1/8"

Esso - Operating Gas Station
 30-9106 \$179.95
 Measures: 15" x 11" x 6 3/4"



**Bay Door Opens, Car
 Pulls Out For Fill-Up**



Union 76 - Operating Gas Station
 30-9109 \$179.95
 Measures: 15" x 11" x 6 3/4"



Gray & White - Public Works Building
 30-90007 \$49.95
 Measures: 14 1/8" x 9 7/8" x 8 1/8"

**Buildings Feature
 Interior Lighting!**



Tippy's Tacos - Fast Food Restaurant Stand
 30-90085 \$69.95
 Measures: 14 1/2" x 12" x 7 1/2"



RailTown City Bank - Bank w/Coin Slot
 30-90223 \$79.95
 Measures: 9 1/2" x 17 15/16" x 9 1/8"



Burger Chef - Fast Food Restaurant Stand
 30-90084 \$69.95
 Measures: 14 1/2" x 12" x 7 1/2"

RailTown™ Buildings



Red & Brown - 3-Story Town House #1
30-90505 \$49.95
Measures: 4 1/8" x 6 3/4" x 7 11/16"

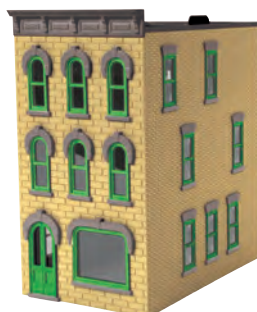

Cream & Green - 3-Story Town House #1
30-90506 \$49.95
Measures: 4 1/8" x 6 3/4" x 7 11/16"



Cream & Brown - 3-Story Town House #3
30-90510 \$49.95
Measures:
4 1/8" x 6 3/4" x 7 11/16"



Red & Gray - 3-Story Town House #3
30-90509 \$49.95
Measures: 4 1/8" x 6 3/4" x 7 11/16"

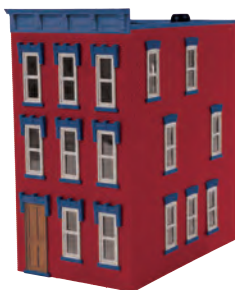

Light Tuscan Brick - 3-Story
Town House #3
30-90376 \$49.95
Measures:
4 1/8" X 6 3/4" X 7 11/16"



Gray & Green - 3-Story Town House #2
30-90507 \$49.95
Measures: 4 1/8" x 6 3/4" x 7 11/16"

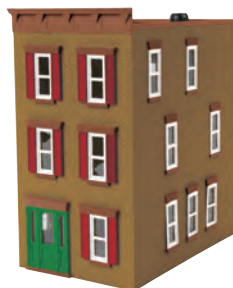

Tan & Red - 3-Story Town House #2
30-90508 \$49.95
Measures: 4 1/8" x 6 3/4" x 7 11/16"



Chesapeake Crab Barn - Road Side Stand
 30-90503 \$49.95
 Measures: 8 1/2" x 5 7/16" x 4 1/4"



Christmas Tree House - Road Side Stand
 30-90504 \$49.95
 Measures: 8 1/2" x 5 7/16" x 4 1/4"

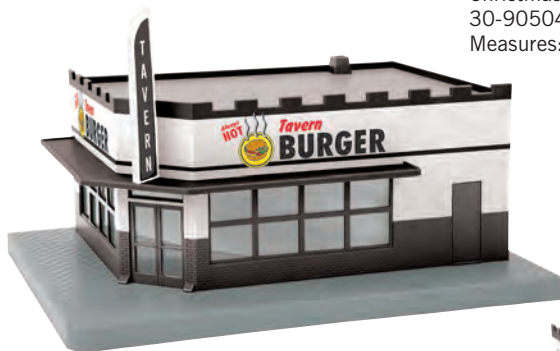

Tavern Burger - Single Story Corner Store
 30-90392 \$59.95
 Measures: 10 3/8" x 8 3/8" x 6 1/4"



Squeaky's Auto Parts - Single Story Corner Store
 30-90448 \$59.95
 Measures: 10 3/8" x 8 3/8" x 6 1/4"



Downtown Hobby - Single Story Opposite Corner Store
 30-90451 \$59.95
 Measures: 10 3/8" x 8 3/8" x 6 1/4"



Wine Shop - Single Story Opposite Corner Store
 30-90450 \$59.95
 Measures: 10 3/8" x 8 3/8" x 6 1/4"

RailTown Buildings



Tom's Toggery - 3-Story City Building
 30-90486 \$69.95
 Measures: 8 1/4" x 10" x 10 1/8"



Hippy's Tattoos - 3-Story City Building
 30-90487 \$69.95
 Measures: 8 1/4" x 10" x 10 1/8"



Dewey, Cheatum & Howe - 3-Story City Building w/Fire Escape & Blinking Sign
 30-90154 \$79.95
 Measures: 12 3/4" x 6 5/16" x 9 3/16"

Buildings
 Feature
 Interior
 Lighting!



Hubie Skriemen D.D.S. - 3-Story City Building w/Fire Escape & Blinking Sign
 30-90155 \$79.95
 Measures: 12 3/4" x 6 5/16" x 9 3/16"



Ives - 3-Story City Building 1
 30-90440 \$69.95
 Measures: 8 1/4" x 10" x 10 1/8"



Eatie Gourmet's - 3-Story City Building 1
 30-90351 \$69.95
 Measures: 8 1/4" x 10" x 10 1/8"



Norman's Taxidermy - Corner Building
w/Blinking Sign
30-90475 \$59.95
Measures: 9 7/8" x 7 7/16" x 7 1/16"



Today's Vinyl Records - Opposite Corner
Building w/Blinking Sign
30-90477 \$59.95
Measures: 9 7/8" x 7 7/16" x 7 1/16"



Benedetto Brooklyn Meats & Deli -
Opposite Corner Building w/Blinking Sign
30-90476 \$59.95
Measures: 9 7/8" x 7 7/16" x 7 1/16"



Ali's Tiki Bar - Corner Building w/
Blinking Sign
30-90474 \$59.95
Measures: 9 7/8" x 7 7/16" x 7 1/16"

Buildings Feature Interior Lighting!



New Genco Importing Co. -
3-Story City Building 1
30-90500 \$69.95
Measures: 8 1/4" x 10" x 10 1/8"



Doolittle & Daily Retirement Apartments -
4-Story Building
30-90347 \$69.95
Measures: 9 1/16" x 8 11/16" x 13 9/16"

RailTown Buildings



Sequentially Lighted
Marquee Sign and
Interior Lighting

Greyhound - Bus Station
30-9040 \$149.95
Measures: 16 3/4" x 18 1/8" x 9 1/16"
Includes die-cast bus

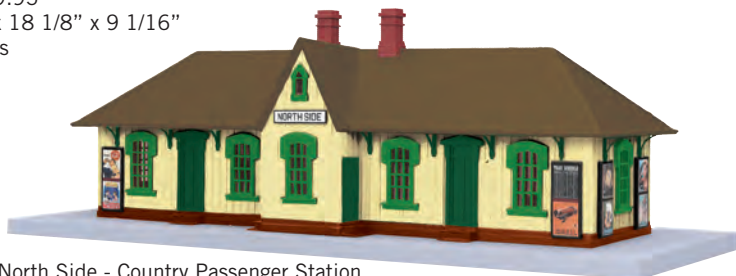

North Side - Country Passenger Station
30-90516 \$69.95
Measures: 18 5/8" x 7 3/8" x 6 5/8"



South Side - Country Passenger Station
30-90517 \$69.95
Measures: 18 5/8" x 7 3/8" x 6 5/8"



MARS - M&M'S® - Country Passenger Station
30-90456 \$69.95
Measures: 18 5/8" x 7 3/8" x 6 5/8"



©/™ M&M'S, the letter M and the M&M'S Characters are registered trademarks of Mars, Incorporated and its affiliates.
©MARS, Incorporated 2016

Dark Red Brick - Passenger Station
w/dual Platforms
30-90094 \$109.95
Measures: 39" x 10 1/2" x 8 1/2"



Hooterville - Train Depot
30-90501 \$59.95
Measures: 11 1/2" x 7 3/4" x 4 3/4"



Gray w/Green Roof - Passenger
Station Platform
30-90315 \$24.95
Measures: 10" x 3 1/2" x 4"



Elevated Station Platform
30-90027 \$34.95
Measures: 13 1/2" x 5 1/2" x 4"

**Buildings Feature
Interior Lighting!**



Red & Black - Country Freight Station
30-90004 \$39.95
Measures: 9" x 5 1/2" x 5"



Dual Stall Engine Shed
30-90425 \$119.95
Measures: 24" x 8 1/2" x 8 3/4"



Single Stall Engine Shed
30-90423 \$89.95
Measures: 24" x 5 1/2" x 8 3/4"

**Compatible with
Lionel® FasTrack™**

RailTown Buildings

Door Opens and
Watchman Pops Out
of Lighted Shanty!



New York Central - Operating Watchman's Shanty
30-9186 \$79.95
Measures: 4 1/2" x 5 15/16" x 4 1/8"



Operating Watchman's Shanty
30-9185 \$79.95
Measures: 4 1/2" x 5 15/16" x 4 1/8"



Brown & Black -
Elevated Gate Tower
30-9097 \$29.95
Measures:
3 1/2" x 2 1/2" x 5 3/4"



Union Pacific - Switch Tower
30-90430 \$54.95
Measures: 6 1/8" x 10 1/2" x 9"



Strasburg - Switch Tower
30-90429 \$54.95
Measures: 6 1/8" x 10 1/2" x 9"



#5 Country Church
 30-90518 \$39.95
 Measures: 7 7/8" x 4 5/8" x 10 9/16"



Patterson & Co. Mining Bureau -
 2-Story Store Front Building
 30-90275 \$54.95
 Measures: 6 1/2" x 8" x 8 5/8"



Gray & Maroon - Trackside Yard Tower
 30-90006 \$39.95
 Measures: 4" x 4" x 7 1/2"



**Buildings
 Feature
 Interior
 Lighting!**

S&D Dry Goods and Provisions -
 2-Story Store Front Building
 30-90164 \$54.95
 Measures: 6 1/2" x 8" x 8 5/8"



Ice Cream - Country Store
 30-90437 \$59.95
 Measures: 8 7/8" x 5 1/8" x 5 1/2"



Model Train - Country Store
 30-90436 \$59.95
 Measures: 8 7/8" x 5 1/8" x 5 1/2"

RailTown Buildings



King Soda - Barn
30-90498 \$79.95
Measures: 16 1/2" x 18 3/4" x 9 1/2"



Barn
30-90407 \$79.95
Measures: 16 1/2" x 18 3/4" x 9 1/2"

**Buildings
Feature
Interior
Lighting!**



Red & Brown - Barn
30-90502 \$79.95
Measures: 16 1/2" x 18 3/4" x 9 1/2"



Gray Stone - Granary
30-90188 \$69.95
Measures: 10 1/4" x 7" x 11 1/8"



Grace Valley Feed and Supply -
Dry Goods Transfer Warehouse
30-90082 \$79.95
Measures: 13 1/2" x 8 1/4" x 9 1/8"



Country Bingo Hall
30-90466 \$39.95
Measures: 9 1/4" x 6 1/8" x 5"



Country School House
30-90465 \$39.95
Measures: 9 1/4" x 6 1/8" x 5"



Light Green & Red - #6 Farm House
30-90511 \$49.95
Measures: 7 1/2" x 7 1/2" x 7"



Cream & Brown - #6 Farm House
30-90512 \$49.95
Measures: 7 1/2" x 7 1/2" x 7"

**Buildings
Feature
Interior
Lighting!**



Red & Green - #4 Country House
30-90513 \$49.95
Measures: 9 5/8" x 5" x 7"



Yellow - #4 Country House
30-90186 \$49.95
Measures: 9 5/8" x 5" x 7"

RailTown Buildings



Yellow & Blue - Row House #2
 30-90514 \$39.95
 Measures: 8 1/2" x 4 5/8" x 7"



Light Blue & Green - Row House #2
 30-90515 \$39.95
 Measures: 8 1/2" x 4 5/8" x 7"



Mustard & Red - Work House #1
 30-90008 \$34.95
 Measures: 8 5/8" x 4 7/16" x 4 7/8"



Cream & Oxide - Work House #2
 30-90011 \$34.95
 Measures: 8 5/8" x 4 7/16" x 4 7/8"



Blue & White - Telephone Shanty
 30-90002 \$12.95
 Measures: 2" x 1 5/16" x 2 11/16"

Blue & Black -
 Work House #1
 30-90009 \$34.95
 Measures: 8 5/8" x 4 7/16" x 4 7/8"

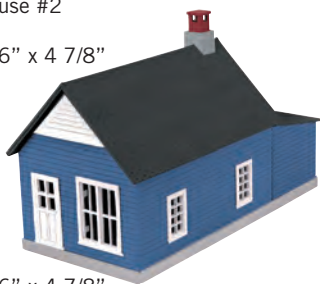

Gray & Black - Work House #2
 30-90010 \$34.95
 Measures: 8 5/8" x 4 7/16" x 4 7/8"



Gray & White - Out House
 30-90001 \$12.95
 Measures:
 1 3/16" x 1 5/16" x 2 7/16"

Trucks and Couplers

3-Rail



RailKing 3-Rail Bettendorf Freight Car
Two-Truck Pack
30-89001 \$19.95
RailKing 3-Rail Roller Bearing Freight Car
Two-Truck Pack
30-89002 \$19.95



Premier 3-Rail Bettendorf Freight Car
Two-Truck Pack
20-89003 \$24.95
Premier 3-Rail Roller Bearing Freight Car
Two-Truck Pack
20-89004 \$24.95

Premier 2-Rail



2-Rail Bettendorf Freight Car Two-Truck Pack
20-89001 \$24.95
2-Rail Roller Bearing Freight Car
Two-Truck Pack
20-89002 \$24.95
2-Rail Lightweight Passenger Car
Two-Truck Pack
20-89007 \$29.95



2-Rail Heavyweight Passenger Car
Two-Truck Pack
20-89014 \$29.95
2-Rail Bettendorf Caboose Two-Truck Pack
20-89015 \$24.95
2-Rail Roller Bearing Caboose Two-Truck Pack
20-89016 \$24.95
2-Rail 64' Woodsided Passenger Car Two-Truck Pack
20-89012 \$29.95



Proto-Scale 3-2™ 4-Wheel
Truck Scale Wheel Set
20-89005 \$39.95
Proto-Scale 3-2 6-Wheel Truck
Scale Wheel Set
20-89006 \$59.95
Proto-Scale 3-2 4-Wheel Truck
Hi-Rail Wheel Set
20-89008 \$39.95
Proto-Scale 3-2 6-Wheel Truck
Hi-Rail Wheel Set
20-89009 \$59.95



No. 804 Kadee Coupler & Draft Gear Box
Set (Plastic)
20-89018 \$4.75
No. 805 Kadee Coupler & Draft Gear Box
Set (Metal)
20-89019 \$4.75

End-Of-Train-Device Roller Bearing Freight Truck

White End-of-Train-Device Roller Bearing Freight Truck
20-89013 \$24.95
Yellow End-of-Train-Device Roller Bearing Freight Truck
20-89010 \$24.95



Flashing Red LED



Proto-Sound 2.0 10-Pin Wireless Drawbar Set
20-89011 \$29.95
Proto-Sound 3.0 6-Pin Wireless Drawbar Set 1
20-89020 \$29.95
Proto-Sound 3.0 6-Pin Wireless Drawbar Set 2
20-89021 \$29.95

O Gauge RealTrax®

Rugged - Realistic - Reliable

At M.T.H. we believe a track system should allow your model railroad empire to grow. The RealTrax system includes 72 different components for maximum expansion capabilities. You'll find bridges, curves of all sizes, elevated and graduated trestles, crossovers, and every straight and curved configuration you'll need to create your own model railroad empire. And every piece of RealTrax is rugged, realistic, and reliable so you can have fun running your trains.



Rugged

Because most toy train empires begin on a carpet or floor, RealTrax is designed to hold up to the rigors of childhood play. Strong snap-together connections make it easy to assemble or change a layout in minutes. And the built-in roadbed helps keep dirt on the floor away from the wheels and gears of your trains.

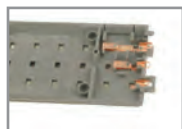

Realistic

With its realistic crosssties and ballasted roadbed, RealTrax looks like the mainline track used by heavy freights and high-speed passenger trains. Unlike older O gauge track with a round cross section, RealTrax uses flat-top "T"-rail like a real railroad.

Reliable

Nickel silver rail ensures that RealTrax will never rust. Spring-loaded phosphor bronze contacts provide superior electrical connections between track sections. The contacts are spring loaded to maintain a solid connection over time and are highly resistant to corrosion of any kind.

RealTrax switches feature the same durable construction as regular RealTrax sections and utilize long-lasting switch motors that provide precise throws every time. The reversible motor mechanism quickly snaps onto the other side of the switch if space is a problem. No disassembly of the switch is required! Lighted switch controllers allow you to throw a switch remotely from a distance, and lights on the controller indicate which direction the switch is thrown - green for straight and red for curved.

REALTRAX®
BY M.T.H. - THE MODEL TRAIN EXPERTS

IT TAKES **EIGHT O-31 CURVES** TO MAKE A CIRCLE.
IT TAKES **TWELVE O-42 CURVES** TO MAKE A CIRCLE.
IT TAKES **TWELVE O-54 CURVES** TO MAKE A CIRCLE.
IT TAKES **SIXTEEN O-72 CURVES** TO MAKE A CIRCLE.
IT TAKES **SIXTEEN O-82 CURVES** TO MAKE A CIRCLE.

RealTrax - 10" Ground Track
40-1068-2 \$8.99



RealTrax - 10" Straight Track Section
40-1001 \$4.49

RealTrax -
5.5" Track Section
40-1012 \$3.99

RealTrax -
5.0" Track Section
40-1016 \$3.99

RealTrax -
4.25" Track Section
40-1017 \$3.99

RealTrax -
3.5" Track Section
40-1018 \$3.99

Crossover & Operating Sections

RealTrax -
90° Crossover Track
40-1006 \$24.95

RealTrax -
45° Crossover Track
40-1007 \$24.95

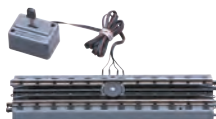

RealTrax -
Operating Track Section
40-1008 \$29.95
(activates M.T.H., Lionel and other brands of operating cars)



RealTrax - Adapter Track Section
40-1011 \$8.99

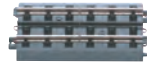

RealTrax - 5" Insulated Straight Track Section Set
40-1029 \$8.99



Tubular Track Not Included

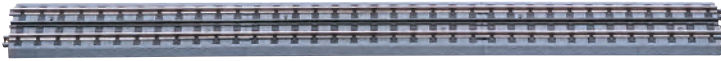

RealTrax - 30" Straight Track Section
40-1019 \$12.99



RealTrax -
O-31 Half Curve Track
40-1022 \$3.99



RealTrax -
O-42 Half Curve Track
40-1045 \$4.49



RealTrax -
O-54 Half Curve Track
40-1057 \$4.99



RealTrax -
O-72 Half Curve
Track Section
40-1049 \$4.99



RealTrax -
O-31 Curved Track Section
40-1002 \$4.49



RealTrax -
O-42 Curved Track Section
40-1042 \$4.99



RealTrax -
O-54 Curved Track Section
40-1054 \$4.99

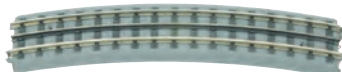

RealTrax - O-72 Curved Track Section
40-1010 \$5.99



RealTrax - O-82 Curved Track Section
40-1082 \$5.99

Switches

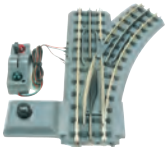

RealTrax -
O-31 Switch (RH)
40-1004 \$64.95

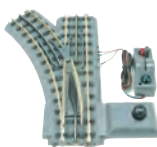

RealTrax -
O-31 Switch (LH)
40-1005 \$64.95

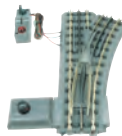

RealTrax -
O-42 Switch (RH)
40-1043 \$74.95

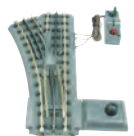

RealTrax -
O-42 Switch (LH)
40-1044 \$74.95



RealTrax -
O-54 Switch (LH)
40-1056 \$79.95



RealTrax -
O-72 Switch (LH)
40-1021 \$89.95

RealTrax -
O-54 Switch (RH)
40-1055 \$79.95

RealTrax -
O-72 Switch (RH)
40-1020 \$89.95

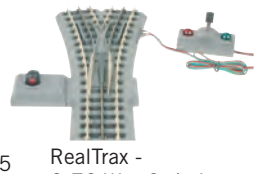

RealTrax -
O-72 Wye Switch
40-1068 \$89.95

O Gauge RealTrax®

- O Girder Bridge - Rust
40-1104 \$34.95
- O Girder Bridge - Silver
40-1102 \$34.95
- O Girder Bridge - Black
40-1106 \$34.95



***Bridges now compatible
with Lionel® FasTrack™**

- O 2-Track Girder Bridge - Rust
40-1110 \$39.95
- O 2-Track Girder Bridge - Silver
40-1108 \$39.95
- O 2-Track Girder Bridge - Black
40-1112 \$39.95



- O 2-Track Steel Arch Bridge - Rust
40-1109 \$99.95
- O 2-Track Steel Arch Bridge - Silver
40-1107 \$99.95
- O 2-Track Steel Arch Bridge - Black
40-1111 \$99.95



- O Steel Arch Bridge - Rust
40-1103 \$79.95
- O Steel Arch Bridge - Silver
40-1101 \$79.95
- O Steel Arch Bridge - Black
40-1105 \$79.95

**Includes Flashing
Bridge Beacon**



- O Subway Trestle Bridge
40-1148 \$34.95



- Tunnel Portal -
Double Track
40-9015 \$19.95



- Tunnel Portal -
Single Track
40-9014 \$14.95



8 Piece Elevated Subway Trestle Set
40-1047 \$34.95
8 Piece Elevated Subway Trestle Set For Lionel Fastrack
40-1157 \$39.95

100 WATT POWER SUPPLY!



Power & Track Pack
40-1071 \$169.95



RealTrax - 24-Piece Graduated Trestle System
40-1033 \$54.95
RealTrax - 24-Piece Graduated Trestle System
For Lionel Fastrack
40-1113 \$54.95



RealTrax - 8-Piece Elevated Trestle System
40-1034 \$34.95
RealTrax - 8-Piece Elevated Trestle System
For Lionel Fastrack
40-1134 \$34.95



RealTrax - Lighted Lockon
40-1003 \$5.99

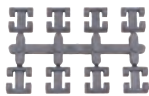

RealTrax -
Track Clips (24)
40-1041 \$7.95



RealTrax - Non-Slip
Track Pads (50/pack)
40-1046 \$7.95



RealTrax -
Lighted Bumper
40-1024 \$14.95



RealTrax - Track Activation
Device (I.T.A.D.)
40-1028 \$24.95

Layout Builders

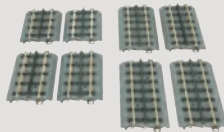

RealTrax - Layout Builder (8 Pcs)
40-1023 \$29.95
(Contains: (2) 3.5" Half Tracks, (2) 4.25"
Half Tracks, (2) 5.0" Half Tracks, (2) 5.5"
Half Tracks)

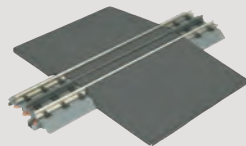

RealTrax - Grade Crossing
40-1009 \$9.95

RealTrax - Figure 8 Layout Builder
40-1025 \$59.95

(Contains: (4) 0-31 Curves, (4) 10" Straights,
(1) Lighted Lockon, (1) 90 Degree Crossover)

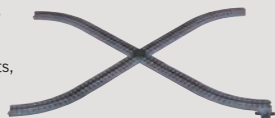

RealTrax - Right Hand Track
Siding Layout Builder
40-1027 \$89.95

(Contains (1) Right-Hand 0-31 Switch, (4)
10" Straights, (1) 0-31 Curve, (1) RealTrax™
Bumper)



RealTrax - Left Hand Track
Siding Layout Builder
40-1026 \$89.95

(Contains (1) Left-Hand 0-31 Switch, (4)
10" Straights, (1) 0-31 Curve, (1) RealTrax
Bumper)



(Contains (1) 0-72 Wye
Switch, (6) 10" Straights,
(2) Lighted Bumpers,
(2) 0-72 Half Curves)

RealTrax
0-72 Wye Switch Spur Layout Builder
40-1069 \$149.95

RealTrax® Layouts

STORY OF OIL 13x23 FEET

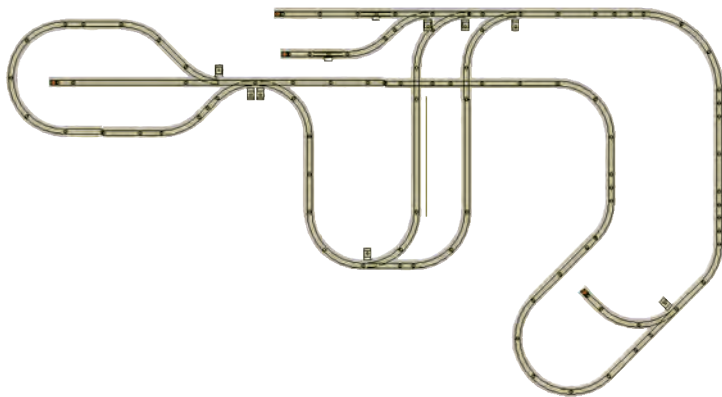

This layout is a good example of how a loop can be elaborated until it doesn't look like a loop anymore. This track plan also thinks like a point to point, because we are following the entire cycle of the oil business, from the oil well to the gas pump and beyond. On the left we have the oil fields and the storage tanks for the freshly extracted crude oil. At the storage tank station, you can fill tank cars with black gold. These tank cars will be dropped off at the oil refinery in the middle of the layout. You'll need to build the refinery yourself, but it's a relatively easy model to build. Refineries are basically flat-roof metal buildings surrounded by LOTS of pipes and storage tanks. Empty tin cans, tin foil, and lots of flexible drinking straws colored silver with a paint marker will create the effect quite nicely.

Behind the refinery is a plastics factory. Here you drop tankers of oil on one track and carry away covered hoppers full of plastic pellets from the other track.

Finally, we pass into a suburban area with houses and a gas station. This gas station is unusual in that it receives its gasoline in a tank car that you leave on the siding in the back, rather than having it trucked in. The operating gas station and car wash add the final touch of delivering the gas to consumers!

TRACK REQUIRED

- (38) MTH 40-1001 10 inch straight
- (7) MTH 40-1016 5.0 inch straight
- (3) MTH 40-1019 30 inch straight
- (4) MTH 40-1024 track bumper
- (5) MTH 40-1043 0-42 lefthand switch
- (3) MTH 40-1044 0-42 righthand switch
- (40) MTH 40-1042 0-42 curve
- (6) MTH 40-1017 4.25 inch straight
- (2) MTH 40-1006 90° cross
- (6) MTH 40-1012 5.5 inch half straight
- (2) MTH 40-1008 uncoupling track
- (4) MTH 40-1018 3.5 inch straight

ACTION IN 3x6 FEET

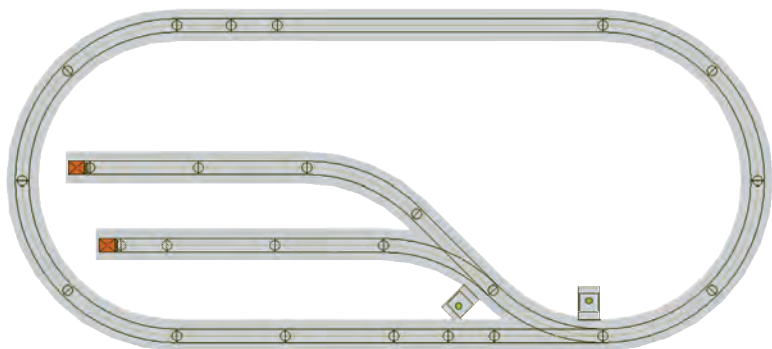

Here's a layout small enough to fit in a bedroom, yet still big enough to give you the fun of real railroading. The track plan is basically a loop, but the small yard enables you to have passengers and switching operations, in addition to continuous running trains. With detailed scenery, this layout makes a pleasing and enjoyable railroad for the modeler with limited space.

TRACK REQUIRED

- (9) MTH 40-1002 0-31 curve
- (1) MTH 40-1019 30 in straight
- (3) MTH 40-1017 4.25 in straight
- (2) MTH 40-1016 5.0 in straight
- (1) MTH 40-1004 031 righthand switch
- (1) MTH 40-1005 031 lefthand switch
- (6) MTH 40-1001 10 inch straight
- (2) MTH 40-1024 track bumper

SPACE

The most important limitation most railroads encounter is space. Does the house have a spare room, basement, or attic? These are by far the most popular places for model railroads, because they use space that nobody else in the house wants. That means the railroad can be set up permanently, with appropriate lighting, backgrounds, seating, and even a little workbench for assembling buildings, painting cars and so on. If you are lucky to have such a space available, get a tape measure and plot out how large the room is. The size and shape of the room will help define your railroad.

RealTrax® Layouts

DOUBLE TRACK IN 4x8 FEET

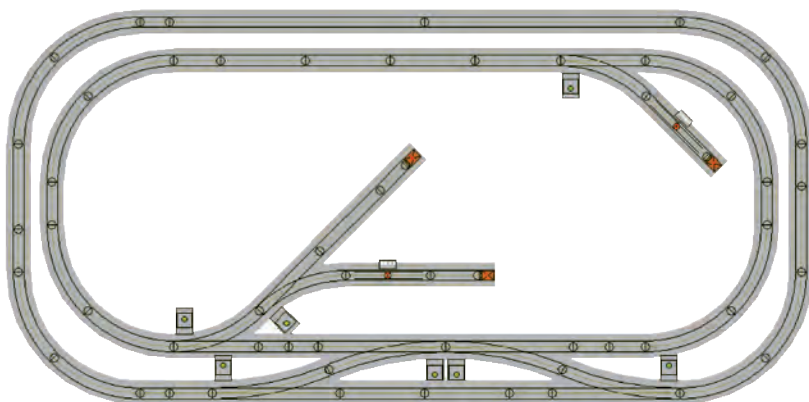

This layout strikes a nice balance between action and scenery. Create a contrast between town and country by using scenic separation to stretch the 4x8 feet into a whole countryside. Your town might have an attractive station (complete with street clock and operating American flag) and a coal loader, as well as a water tank for your engines. Add a lake and a farm on the opposite shore, with a siding for picking up milk cans in the morning and unloading empties in the evening. And with two tracks, you can run two trains at a time, ensuring constant movement.

SHAPE

Often, instead of getting an entire room or basement to itself, a railroad can acquire several small adjoining areas, spread across one or more rooms. Perhaps the main line will fill the corner of the basement rumpus room, with storage yard tracks running through a tunnel in the wall and onto a shelf over the washer and dryer. Perhaps the line can fill shelves along two walls of a room.

These kinds of limitations can radically change the track plan of your railroad. In addition, these sorts of small intrusions into other space can provide areas of expansion for a more conventional train table line that needs room to grow.

TRACK REQUIRED

- (16) MTH 40-1002 0-31 curve
- (1) MTH 40-1005 031 lefthand switch
- (2) MTH 40-1004 031 righthand switch
- (4) MTH 40-1018 3.5 in straight
- (9) MTH 40-1001 10 inch straight
- (2) MTH 40-1012 5.5 inch half straight
- (3) MTH 40-1017 4.25 in straight
- (6) MTH 40-1016 5.0 in straight
- (2) MTH 40-1019 30 in straight
- (2) MTH 40-1020 072 righthand switch
- (2) MTH 40-1021 072 lefthand switch
- (3) MTH 40-1024 track bumper
- (2) MTH 40-1008 uncoupling track
- (2) MTH 40-1014 10 inch girder bridge

MAX ACTION IN 4x8 FEET

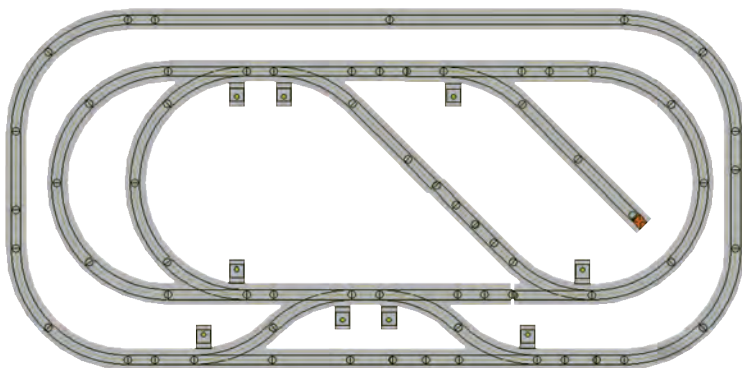

Just as the name implies, this track plan really packs in the activity! As many tracks as will fit, plus all the operating accessories to keep them humming, make this a great plan for the modeler who likes to keep his freight trains busy. With two tracks, you can keep a train rolling at all times while another works its way around serving the many industries in this town. Accessorize this layout with lighted Rail-Town buildings and an operating coaling tower, water tower, freight transfer dock, or crossing gates, and you and your visitors will have plenty to see and do!

TRACK REQUIRED

- (18) MTH 40-1002 0-31 curve
- (2) MTH 40-1019 30 in straight
- (6) MTH 40-1001 10 inch straight
- (5) MTH 40-1016 5.0 in straight
- (6) MTH 40-1004 031 righthand switch
- (16) MTH 40-1018 3.5 in straight
- (2) MTH 40-1012 5.5 inch half straight
- (3) MTH 40-1017 4.25 in straight
- (3) MTH 40-1005 031 lefthand switch
- (1) MTH 40-1024 track bumper

ROOM TO OPERATE

The kinds of railroad action you most enjoy will also influence your layout. Do you like lots of switching cars in the yard? Then your layout will feature a big yard, which often works well on a shelf. Do you want long mainline runs through rural terrain? Then your layout will probably require a twice-around loop with mountains, trees, or other view blockers to make the trip look longer.

RealTrax® Layouts

TWICE AROUND 4x8 FEET

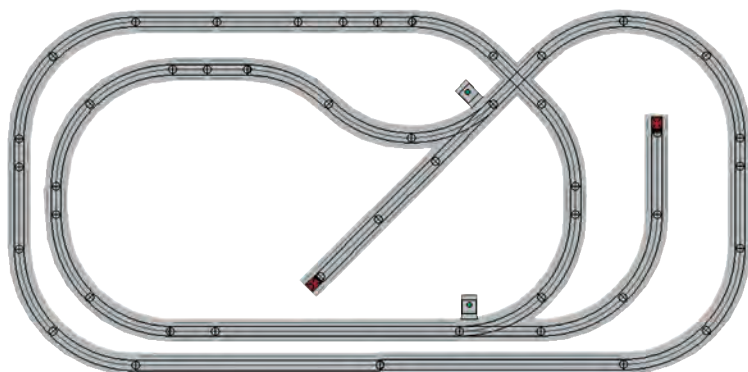

One way of making your layout seem bigger is to have the trains make two trips around the table before it gets back to the starting point. This track plan does just that. It also includes a couple of sidings for you to pick up and drop off cars. If you have more room and can put in more straight track, this plan can become very realistic.

TRACK REQUIRED

- (4) MTH 40-1018 3.5 in straight
- (20) MTH 40-1002 0-31 curve
- (3) MTH 40-1019 30 in straight
- (7) MTH 40-1001 10 inch straight
- (1) MTH 40-1006 90° cross
- (3) MTH 40-1017 4.25 in straight
- (2) MTH 40-1012 5.5 inch half straight
- (1) MTH 40-1005 O31 lefthand switch
- (1) MTH 40-1004 O31 righthand switch
- (1) MTH 40-1016 5.0 in straight
- (2) MTH 40-1024 track bumper

THE SCENIC ROUTE

The style of scenery you want will also determine the shape of your layout. Mountains and bridges will require more up and down space than fields and forests. A desert will make a big open, flat area, that may require a mountain to hide the other end of the track. Cities can look great and provide a real contrast with rural scenery, but buildings do take up considerable space. Tracks move differently through different kinds of terrain, with a mountain logging railroad having a very different track plan from the Union Pacific roaring across the Nebraska cornfields.

TRAIN TIME

Tracks were also used differently at varying points in history. If you are modeling the 1850s, there won't be much call for double-track mainlines or complex switchyards. On the other hand, if you are modeling today's high-speed container trains, complex yards and multi-track should be the rule.

WILD WEST/CIVIL WAR 10x10 FEET

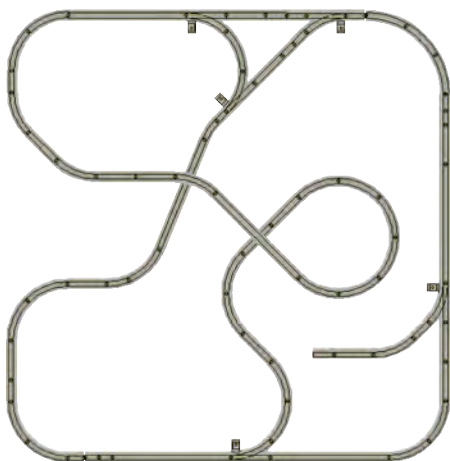

This is an old-time layout which incorporates several interesting features. The most challenging is the helix curve around the mountain, where the train passes over itself. This not only gives you a cool over/under effect, but it captures the rugged flavor of early railroads clawing their way through the mountains to open up the country. This will require a relatively steep grade, but since 1860s trains were short and pulled by little 4-4-0 locomotives, you shouldn't have trouble operating it. You'll want to be sure to use RailKing engines with Proto-Sound 2, so that you have the speed control, otherwise you might have some runaway trains!

Another important detail is the arrangement of track switches up by the town. This arrangement is called a "wye" because it resembles the letter "Y." It's important because a wye enables you to turn trains around, so they can face either direction. It's sort of like backing your car into a driveway to change directions on a street. A wye can be a helpful addition to all sorts of track plans and the one shown here is about as compact as you can build.

To keep the trains busy, there is also a mine on the side of the mountain, served

by the siding in the lower right corner. The water tank makes sure the trains don't get stuck out in the wilderness, miles from town. And the track from the bottom of the wye passes through a tunnel in the mountain, which is always a popular sight with visitors.

If you want to represent the Wild West, you can paint your scenery in desert shades of orange and brown, with little cacti and tumbleweeds. For a Civil War scene, cover the mountains with pine trees, and fill the fields with grass, farm crops, and soldiers. In the West, the mine might be producing gold or silver, in the Civil War, it's probably digging coal.

TRACK REQUIRED

- (24) MTH 40-1002 0-31 curve
- (6) MTH 40-1019 30 in straight
- (3) MTH 40-1005 031 lefthand switch
- (14) MTH 40-1001 10 inch straight
- (2) MTH 40-1004 031 righthand switch
- (5) MTH 40-1012 5.5 inch half straight
- (3) MTH 40-1042 O42 curve
- (4) MTH 40-1018 3.5 in straight
- (4) MTH 40-1017 4.25 in straight
- (2) MTH 40-1022 0-31 half curve
- (2) MTH 40-1016 5.0 in straight

RealTrax® Catenary



The RealTrax® Catenary System and RealTrax Catenary Expander are O Gauge's only ready-to-use catenary systems that setup in minutes! Simply position the authentic-looking catenary poles and wires per your layout's requirements, and enjoy the realism of a fully functional easy-to-use catenary system.

8-Piece System Features:

- Compatible with RealTrax® or any other O-Gauge Track
- Removable RealTrax® Lock-On Base Connection
- Thumbscrew Power Terminals
- Adjustable Pole Spacing
- Adjustable Messenger Beam Height
- Adjustable Wire Positioning
- Base Mounting Screws Included



RealTrax - 8-Piece Catenary System
40-1035 \$149.95

RealTrax - 4-Piece Add-On Catenary System
40-1036 \$79.95



Catenary Hardware Pack
40-1039 \$29.95

This Pack Contains: (4) Messenger Expander Plates, (4) Messenger Extension Plates, (16) Screws, (16) Star Lock-Washers, (16) Nuts

Tinplate Standard Gauge Track



Std. Gauge Track w/
Roadbed - 1/2 42"
Diam. Curve
11-99043 \$5.49



Std. Gauge Track w/Roadbed - 72" Diam. Curve
11-99072 \$6.99



Std. Gauge Track w/Roadbed - Lighted Lockon
11-99004 \$5.99

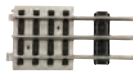

Std. Gauge Track w/
Roadbed- Switch
Adapter Track Section
11-99011 \$8.99



Std. Gauge Track w/
Roadbed - 3.5" Straight
11-99018 \$4.99



Std. Gauge Track w/
Roadbed - 14" Straight
11-99001 \$6.49



Std. Gauge Track w/
Roadbed - Adapter
Track Section
11-99010 \$8.99



Std. Gauge Track w/Roadbed - 7" Straight
11-99002 \$5.49



Std. Gauge Track w/Roadbed - 1/2 72" Diam. Curve
11-99073 \$5.99



Std. Gauge Track w/Roadbed - 28" Straight
11-99003 \$12.99



Std. Gauge Track w/
Roadbed - 42" Diam.
Curve
11-99042 \$6.49



Std. Gauge Track -
84" Dia. Curved
11-99095 \$6.99



Std. Gauge Track -
42" Dia. Reg. Curved
11-99093 \$5.49



Std. Gauge Track -
Straight w/Extra Ties
11-99092 \$5.99



Std. Gauge Track - 72"
Dia. Wide Radius Curve
11-99094 \$5.99



Std. Gauge Track -
1/2 Reg. Straight
11-99096 \$3.99



Std. Gauge Track - 36" Extra
Ties Straight
11-99099 \$10.99



Std. Gauge Track - 36" Straight
11-99098 \$9.99



Std. Gauge Track -
42" Diam. 1/2 Curved
11-99097 \$3.99



Std. Gauge Track -
14" Straight
11-99091 \$5.49



O/Std. Gauge Tubular
Track Activation Device (TAD)
11-99090 \$14.95



O/Std. Gauge Tubular
Track Lighted Lockon
11-99021 \$4.99



Std. Gauge #25
Illuminated Track
Bumper Set
11-99029 \$59.95

Green Base - Std. Gauge Switch -
Right Hand 42" Diam.
11-99044 \$109.95

Green Base - Std. Gauge Switch - Left
Hand 42" Diam.
11-99045 \$109.95

Green Base - Std. Gauge Switch (Wide
Radius) - Right Hand 72" Diam.
11-99074 \$119.95

Green Base - Std. Gauge Switch (Wide
Radius) - Left Hand 72" Diam.
11-99075 \$119.95



Black Base - Std. Gauge Switch -
Right Hand 42" Diam.
11-99046 \$109.95

Black Base - Std. Gauge Switch - Left
Hand 42" Diam.
11-99047 \$109.95

Black Base - Std. Gauge Switch
(Wide Radius) - Right Hand 72
11-99076 \$119.95

Black Base - Std. Gauge Switch
(Wide Radius) - Left Hand 72
11-99077 \$119.95



Std. Gauge #20 90
Degree Crossover
11-99006 \$49.95

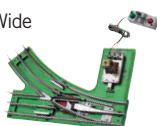

O Gauge ScaleTrax™



ScaleTrax™ by MTH Electric Trains is the ultimate track layout solution for which detail-oriented scale 3-rail model railroaders are searching. No longer will an O Gauge modeler have to accept the “tubular” track look because ScaleTrax™ offers maximum accuracy and the exceptional quality of MTH products. They are perfect for your authentic looking layout.



IT TAKES **EIGHT O-31 CURVES** TO MAKE A CIRCLE.
 IT TAKES **TWELVE O-54 CURVES** TO MAKE A CIRCLE.
 IT TAKES **SIXTEEN O-72 CURVES** TO MAKE A CIRCLE.
 IT TAKES **SIXTEEN O-80 CURVES** TO MAKE A CIRCLE.

Each ScaleTrax™ track section features two solid extruded authentically profiled Nickel Silver rails and one inconspicuous solid extruded center rail - all affixed to accurately sized and spaced track ties. No longer will your consists ride too high off the ground. Best of all, the end-of-rail electrical connectors come pre-welded to the underside of each section. There simply is no need to plug in your soldering iron when using ScaleTrax™.

Whether assembling your first layout, adding to a present layout, or replacing your old track, ScaleTrax™ is the most rugged, realistic, scale proportioned, easy-to-use 3-rail scale O-gauge track system available.

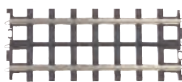

ScaleTrax - 5.0" Track Section
45-1013 \$3.99

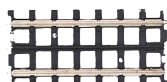

ScaleTrax - 4.25" Track Section
45-1012 \$3.99



ScaleTrax - 1.75" Track Section
45-1011 \$2.49

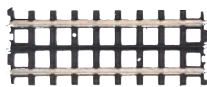

ScaleTrax - 5.5" Track Section
45-1014 \$3.99



ScaleTrax - 10" Straight Track Section
45-1001 \$4.99



ScaleTrax - 30" Track Section
45-1019 \$13.99

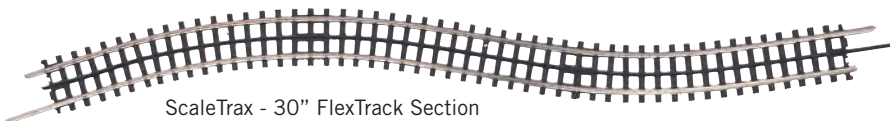

ScaleTrax - 30" FlexTrack Section
45-1049 \$13.99



ScaleTrax - 22.5° Crossing
45-1015 \$24.95

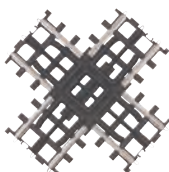

ScaleTrax - 90° Crossing
45-1005 \$19.95

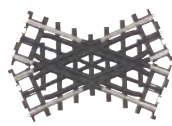

ScaleTrax - 45° Crossing
45-1006 \$19.95



ScaleTrax - 15" Operating Track Section
45-1035 \$24.95



ScaleTrax - O-31 Curved Track Section
45-1002 \$4.99

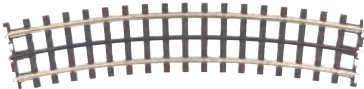

ScaleTrax - O-54 Curved Track Section
45-1007 \$5.29

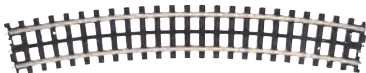

ScaleTrax - O-72 Curved Track Section
45-1010 \$5.99

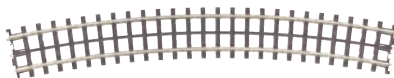

ScaleTrax - O-80 Curved Track Section
45-1034 \$6.99

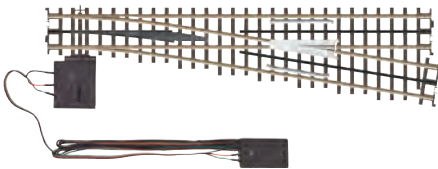

ScaleTrax - No. 6 Switch (LH)
45-1052 \$89.95
ScaleTrax - No. 6 Switch (RH)
45-1053 \$89.95

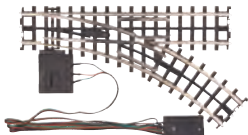

ScaleTrax - O-31 Switch (RH)
45-1004 \$69.95
ScaleTrax - O-31 Switch (LH)
45-1003 \$69.95

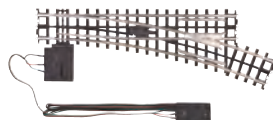

ScaleTrax - O-72 Switch (RH)
45-1020 \$79.95
ScaleTrax - O-72 Switch (LH)
45-1021 \$79.95

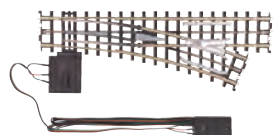

ScaleTrax - O-54 Switch (RH)
45-1009 \$79.95
ScaleTrax - O-54 Switch (LH)
45-1008 \$79.95



ScaleTrax - Bumper
45-1025 \$15.95

ScaleTrax - ITAD
45-1028 \$34.95
Enables passing train to
activate signals and other
accessories.



ScaleTrax™ 2-Rail O-Scale Track



ScaleTrax - 2-Rail 17" Straight Track Section
45-2017 \$7.99



ScaleTrax - 2-Rail 36" Radius Curved Track Section
45-2036 \$8.99



ScaleTrax - 2-Rail 22" Radius Curved Track Section
45-2022 \$7.99



ScaleTrax - Lockon
45-1033 \$4.25
Track Not Included

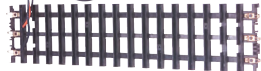

ScaleTrax - No. 4 Switch (LH)
45-1050 \$89.95
ScaleTrax - No. 4 Switch (RH)
45-1051 \$89.95

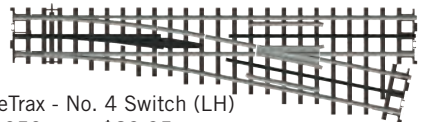

ScaleTrax™ Layout Packages

Don't have the time or inclination to design your own layout? Check out ScaleTrax layout packages, featuring track plans designed in a variety of sizes and shapes, many with the ability to easily expand into a bigger and bigger empire. Each package includes all the track and switches needed to build a complete layout. For details and track plans, click the ScaleTrax logo at the bottom of the M.T.H. home page, www.mthtrains.com. Order the Scaletrax components from any M.T.H. Authorized Retailer and M.T.H. will drop ship your order directly from Maryland. If you prefer to design your own plan use RR Track layout design software and take your design to any M.T.H. Authorized Retailer and we will drop ship the order for them.

Roosevelt Junction

Roosevelt Junction starts small at just 4 ft. by 8 ft., but can grow in four phases to reach an awesome 8 ft. by 16 ft. railroading empire. Each 4 ft. by 8 ft. phase adds new operating possibilities. As you grown in the O Gauge railroading hobby, your layout can grow with you.

Roosevelt Junction - Phase 1

Roosevelt Junction begins as a small railroad with lots of fun. Sidings on both sides of the mainline allow for interesting switching operations between an engine yard and freights sidings. The mainline allows for continuous running when you want to sit back and watch the trains. The passing siding is long enough to accommodate most starter set trains, allowing two trains to pass each other.

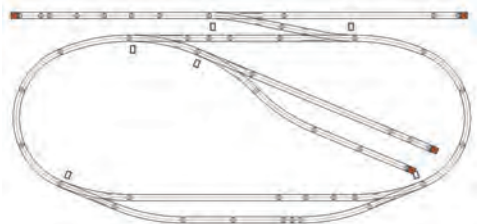

ScaleTrax Pieces

Item #	Description	MSRP	QTY	Extension
45-1001	10 inch straight	\$4.99	6	\$29.94
45-1002	0-31 curve	\$4.99	6	\$29.94
45-1010	0-72 curve	\$5.99	5	\$29.95
45-1011	1.75 inch straight	\$2.49	3	\$7.47
45-1012	4.25 inch straight	\$3.99	6	\$23.94
45-1013	5 inch straight	\$3.99	1	\$3.99
45-1014	5.5 inch straight	\$3.99	6	\$23.94
45-1019	30 inch straight	\$13.99	3	\$41.97
45-1020	0-72 RH switch	\$79.95	3	\$239.85
45-1021	0-72 LH switch	\$79.95	1	\$79.95
45-1025	bumper	\$15.95	4	\$63.80
45-1033	lock-on	\$4.25	6	\$25.50
45-1051	#4 RH switch	\$89.95	2	\$179.90
45-1101	PACKAGE TOTAL: \$780.14			

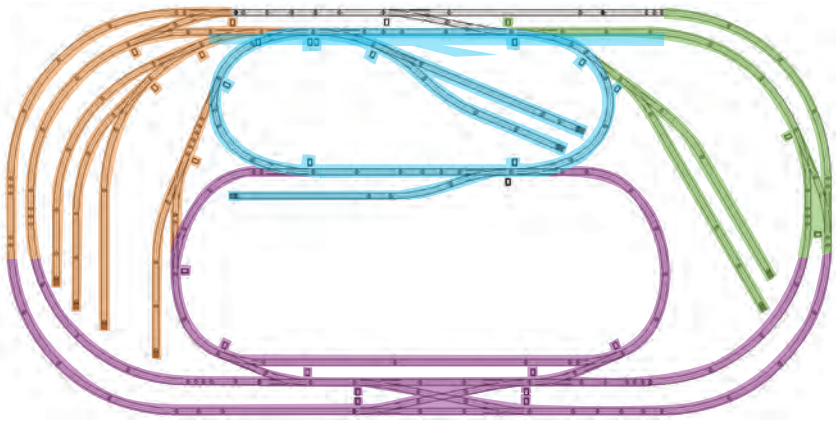

Roosevelt Junction - Phase 2

The second phase of Roosevelt junction adds numerous operating possibilities. The mainline doubles in length, yard capacity nearly triples, and a reversing wye allows entire trains to change direction.

Item #	Description	MSRP	QTY	Extension
45-1001	10 inch straight	\$4.99	3	\$14.97
45-1002	0-31 curve	\$4.99	3	\$14.97
45-1003	0-31 LH switch	\$69.95	1	\$69.95
45-1007	0-54 curve	\$5.29	3	\$15.87
45-1009	0-54 RH switch	\$79.95	1	\$79.95
45-1010	0-72 curve	\$5.99	11	\$65.89
45-1011	1.75 inch straight	\$2.49	11	\$27.39
45-1012	4.25 inch straight	\$3.99	2	\$7.98
45-1013	5 inch straight	\$3.99	3	\$11.97
45-1019	30 inch straight	\$13.99	2	\$27.98
45-1020	0-72 RH switch	\$79.95	6	\$479.70
45-1021	0-72 LH switch	\$79.95	2	\$159.90
45-1025	bumper	\$15.95	4	\$63.80
45-1033	lock-on	\$4.25	7	\$29.75
45-1034	0-80 curve	\$6.99	1	\$6.99
45-1102	PACKAGE TOTAL: \$1077.06			

Roosevelt Junction - Phase 3

The third phase of Roosevelt junction adds still more operating possibilities. The mainline again doubles in length and a long two-track spur is added making a perfect location for engine sheds or dead-end sidings.

Item #	Description	MSRP	QTY	Extension
45-1001	10 inch straight	\$4.99	6	\$29.94
45-1002	0-31 curve	\$4.99	2	\$9.98
45-1004	0-31 RH switch	\$69.95	1	\$69.95
45-1007	0-54 curve	\$5.29	2	\$10.58
45-1009	0-54 RH switch	\$79.95	1	\$79.95
45-1010	0-72 curve	\$5.99	5	\$29.95
45-1011	1.75 inch straight	\$2.49	5	\$12.45
45-1012	4.25 inch straight	\$3.99	1	\$3.99
45-1014	5.5 inch straight	\$3.99	1	\$3.99
45-1019	30 inch straight	\$13.99	2	\$27.98
45-1020	0-72 RH switch	\$79.95	2	\$159.90
45-1021	0-72 LH switch	\$79.95	1	\$79.95
45-1025	bumper	\$15.95	1	\$15.95
45-1033	lock-on	\$4.25	3	\$12.75
45-1034	0-80 curve	\$6.99	3	\$20.97
45-1103	PACKAGE TOTAL: \$568.28			

Roosevelt Junction - Phase 4

The fourth and final addition to Roosevelt Junction transforms the layout into a hi-rail empire. The layout now sports a double track mainline with minimum O-72 curves as well as an interior O-31 loop allowing independent operations of three trains. Carefully located crossovers permit east access from either O-72 mainline into the yards. Three yard spurs connect to the mains with O-72 or larger curves so that even the largest articulated locomotives will feel right at home in Roosevelt Junction.

Item #	Description	MSRP	QTY	Extension
45-1001	10 inch straight	\$4.99	5	\$24.95
45-1007	0-54 curve	\$5.29	1	\$5.29
45-1008	0-54 LH switch	\$79.95	2	\$159.90
45-1009	0-54 RH switch	\$79.95	2	\$159.90
45-1010	0-72 curve	\$5.99	10	\$59.90
45-1011	1.75 inch straight	\$2.49	8	\$19.92
45-1013	5 inch straight	\$3.99	3	\$11.97
45-1014	5.5 inch straight	\$3.99	5	\$19.95
45-1015	22.5 deg crossing	\$24.95	1	\$24.95
45-1019	30 inch straight	\$13.99	2	\$27.98
45-1033	lock-on	\$4.25	5	\$21.25
45-1034	0-80 curve	\$6.99	4	\$27.96
45-1050	#4 LH switch	\$89.95	2	\$179.90
45-1051	#4 RH switch	\$89.95	2	\$179.90
45-1104	PACKAGE TOTAL: \$923.72			

M.T.H. Trade Show Layout - 4 x 8 Freight Central

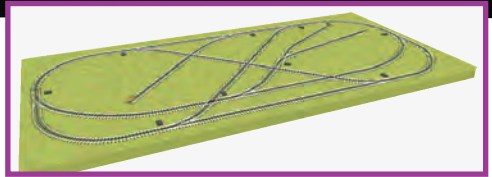
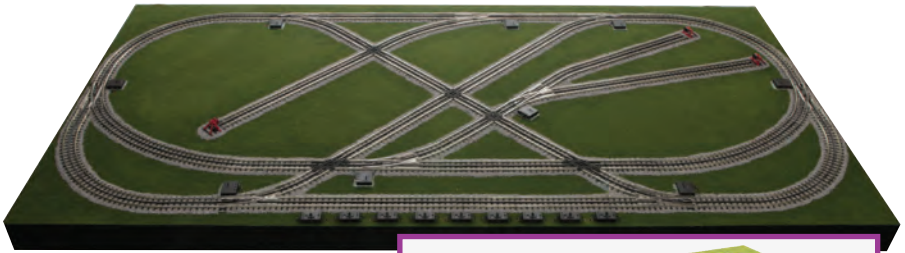
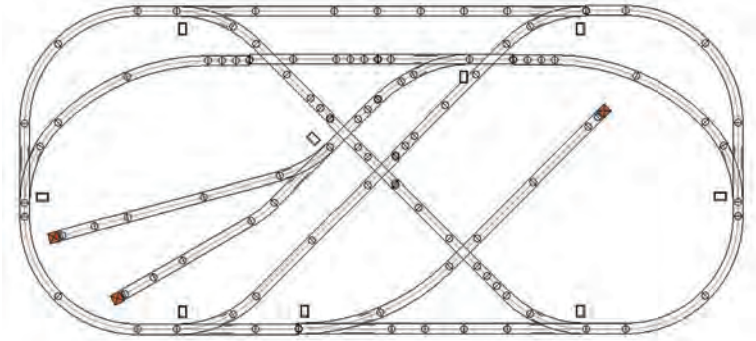

ScaleTrax™ Pieces 45-1108

Item #	Description	MSRP	QTY	Extension
45-1001	10 inch straight	\$4.99	8	\$39.92
45-1002	0-31 curve	\$4.99	8	\$39.92
45-1003	0-31 LH switch	\$69.95	4	\$279.80
45-1004	0-31 RH switch	\$69.95	4	\$279.80
45-1005	90 deg crossing	\$19.95	3	\$59.85
45-1006	45 deg crossing	\$19.95	2	\$39.90
45-1007	0-54 curve	\$5.29	5	\$26.45
45-1008	0-54 LH switch	\$79.95	1	\$79.95
45-1011	1.75 inch straight	\$2.49	24	\$59.76
45-1012	4.25 inch straight	\$3.99	7	\$27.93
45-1013	5 inch straight	\$3.99	5	\$19.95
45-1014	5.5 inch straight	\$3.99	10	\$39.90
45-1025	bumper	\$15.95	3	\$47.85
45-1033	lock-on	\$4.25	4	\$17.00
PACKAGE TOTAL:				\$1057.98

8x9 Spare Room and Pacific RR

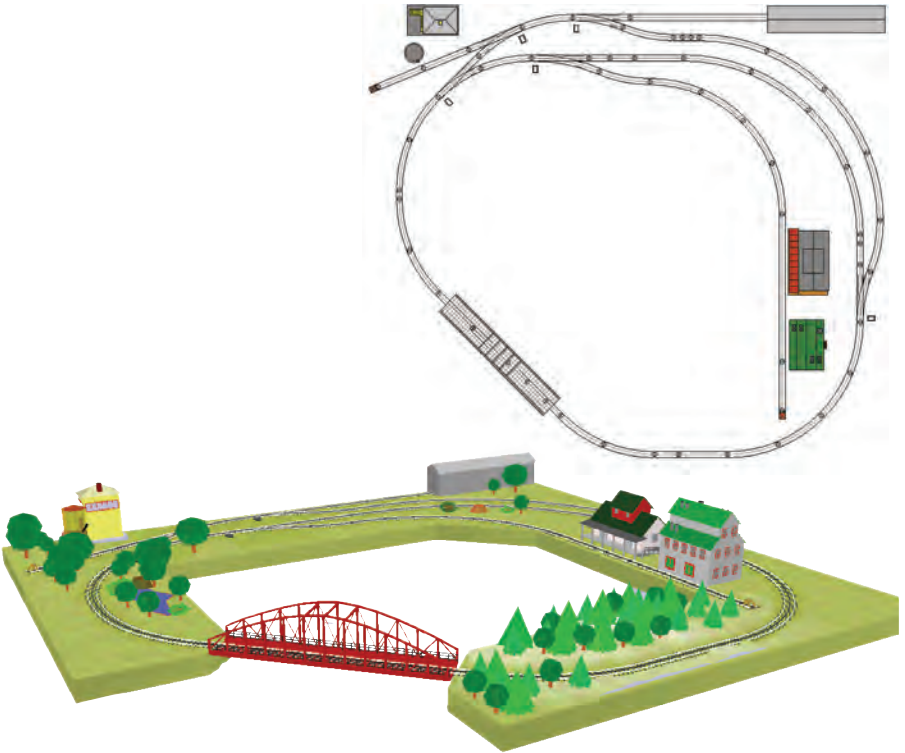

ScaleTrax™ Pieces 45-1105

Item #	Description	MSRP	QTY	Extension
45-1001	10 inch straight	\$4.99	9	\$44.91
45-1007	0-54 curve	\$5.29	19	\$100.51
45-1008	0-54 LH switch	\$79.95	1	\$79.95
45-1009	0-54 RH switch	\$79.95	3	\$239.85
45-1010	0-72 curve	\$5.99	7	\$41.93
45-1011	1.75 inch straight	\$2.49	5	\$12.45
45-1012	4.25 inch straight	\$3.99	3	\$11.97
45-1013	5 inch straight	\$3.99	2	\$7.98
45-1014	5.5 inch straight	\$3.99	2	\$7.98
45-1019	30 inch straight	\$13.99	2	\$27.98
45-1020	0-72 RH switch	\$79.95	1	\$79.95
45-1025	bumper	\$15.95	2	\$31.90
45-1033	lock-on	\$4.25	8	\$34.00
45-1034	0-80 curve	\$6.99	1	\$6.99
PACKAGE TOTAL:				\$728.53

6x10 Main Street

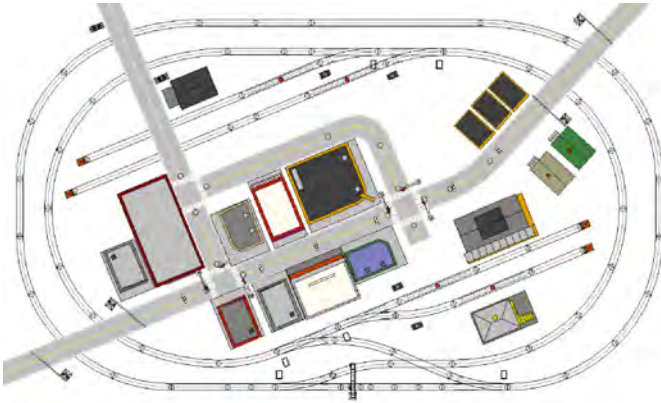

ScaleTrax™ Pieces 45-1107

Item #	Description	MSRP	QTY	Extension
45-1001	10 inch straight	\$4.99	10	\$49.90
45-1007	0-54 curve	\$5.29	30	\$158.70
45-1008	0-54 LH switch	\$79.95	3	\$239.85
45-1009	0-54 RH switch	\$79.95	3	\$239.85
45-1010	0-72 curve	\$5.99	2	\$11.98
45-1011	1.75 inch straight	\$2.49	3	\$7.47
45-1012	4.25 inch straight	\$3.99	5	\$19.95
45-1013	5 inch straight	\$3.99	2	\$7.98
45-1015	22.5 deg crossing	\$24.95	1	\$24.95
45-1019	30 inch straight	\$13.99	3	\$41.97
45-1025	bumper	\$15.95	4	\$63.80
45-1034	0-80 curve	\$6.99	4	\$27.96
45-1035	15" uncoupling section	\$24.95	4	\$99.80
PACKAGE TOTAL:				\$994.16

12x24 Timber Mountain

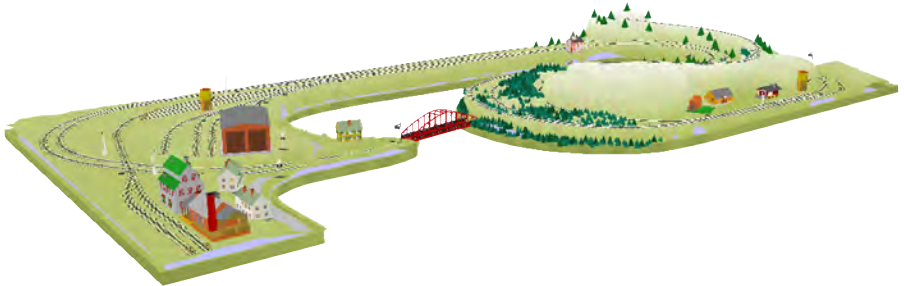
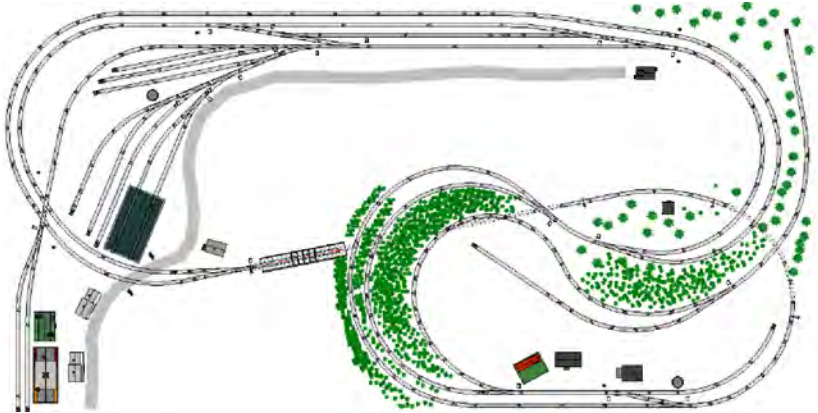

ScaleTrax™ Pieces 45-1106

Item #	Description	MSRP	QTY	Extension
45-1001	10 inch straight	\$4.99	14	\$69.86
45-1006	45 deg crossing	\$19.95	2	\$39.90
45-1007	0-54 curve	\$5.29	10	\$52.90
45-1010	0-72 curve	\$5.99	41	\$245.59
45-1011	1.75 inch straight	\$2.49	4	\$9.96
45-1012	4.25 inch straight	\$3.99	5	\$19.95
45-1013	5 inch straight	\$3.99	1	\$3.99
45-1014	5.5 inch straight	\$3.99	2	\$7.98
45-1019	30 inch straight	\$13.99	30	\$419.70
45-1020	0-72 RH switch	\$79.95	1	\$79.95
45-1021	0-72 LH switch	\$79.95	5	\$399.75
45-1025	bumper	\$15.95	11	\$175.45
45-1033	lock-on	\$4.25	30	\$127.50
45-1034	0-80 curve	\$6.99	22	\$153.78
45-1049	30 inch flex	\$13.99	23	\$321.77
45-1050	#4 LH switch	\$89.95	3	\$269.85
45-1051	#4 RH switch	\$89.95	5	\$449.75
45-1052	#6 LH switch	\$89.95	4	\$359.80
45-1053	#6 RH switch	\$89.95	3	\$269.85
PACKAGE TOTAL:				\$3477.28

POWER UP

with the best transformers in model railroading!



Z-1000™ Transformer
40-1000 \$129.95

**100
Watts**

100-Watt Accessory Power Supply
40-1000A \$89.95
With 14 Volt Accessory Port

Whether you operate with conventional AC power or the M.T.H. Digital Command System (DCS), our UL-approved transformers offer the best way to power your layout. Choose the 100-watt Z-1000™ for a small- to medium-sized layout, or step up to the 400-watt, feature-laden Z-4000®, the most powerful UL-approved transformer in the hobby. All M.T.H. AC transformers offer:

- Incredibly smooth, wide range throttle for precise speed control
- Bell and whistle/horn buttons that work with all makes of AC-powered locomotives
- Fast-acting circuit breakers to protect your equipment
- Continuous useable wave power output, compatible with all AC-powered engines



RailKing Controller Set
40-750C \$59.95



*Includes Z Transformer Controller,
RealTrax lock-on (40-1003), RealTrax wire
harness (40-1015)*

**50
Watts**



Z-500™ Transformer
40-500 \$89.95

*Designed for smaller layouts, the Z-500 offers
the same control features as the Z-1000 but
with less power.*



TIU/Barrel Jack Adapter Cable
50-1017 \$10.95



RealTrax Wire Harness
40-1015 \$4.99



Z-DC1 DC Transformer
40-200 \$29.95

Z-DC300 30 Watt DC Transformer
40-300 \$89.95



- U.L. Approved
- Smooth Operating Throttle Knob
- Built-In Circuit Breaker Protection

**20
Watts**

**30
Watts**

400 Watts!

The Most Powerful UL Listed AC Transformer!

Learn More About It
The instruction manual for every
M.T.H. transformer is available at
www.mthtrains.com
Just look up the transformer in our
Product Search feature.



WHY THE OR LISTING?

To protect our customers and their trains, M.T.H. Electric Trains is committed to manufacturing safe, UL or CSA approved transformers and power supplies. By subjecting our transformers to the strenuous tests and requirements of Underwriters Laboratories and/or CSA, M.T.H. helps ensure that our products meet the same requirements as other consumer electronics sold today. When choosing a new transformer, model railroaders should only look for those that have received a UL or CSA listing.



SIMPLY THE BEST

DCS is **SIMPLE** to use.

It's **ACCESSABLE** from any iOS or Android smart phone, tablet or the included remote.

It can be **UPGRADED FOR FREE** over the Internet.

It can **DO MORE** for less money than other command control systems.

It's why you'll have **MORE FUN** operating your trains than ever before.

It can run over 5300* Proto-Sound® 2.0 & 3.0 engines and every TMCC®, EOB, or Legacy™ engine ever made — and run 99 of them at the same time, on the same track, independently, in command mode.

It can also **RUN ALL CONVENTIONAL AC LOCOMOTIVES** without the purchase of any additional hardware.

With the addition of an Accessory Interface Unit (AIU), it can **OPERATE ANY 0 SCALE ACCESSORY OR SWITCH**. It can **CREATE SCENES AND ROUTES** that are triggered with one push of a button.

* Number of different Proto-Sound 2.0 and 3.0 engines cataloged through the 2015 Volume 1 Catalog. While all Lionel TMCC features can be accessed by the DCS handheld remote, at present some Legacy features cannot be accessed by a DCS remote.



Learn More About It
Shop Online at
www.mthtrains.com

DCS COMPONENTS

- DCS Remote Control System
50-1001 \$349.95
- DCS Remote Control -
Handheld Unit
50-1002 \$169.95



- DCS Track Interface
Unit (TIU)
50-1003 \$199.95



- DCS Accessory Interface
Unit (AIU)
50-1004 \$119.95

- DCS WiFi Module
50-1034 \$179.95



- Proto-Sound Battery
50-1008 \$11.95
- AA NiCad Proto-Sound Battery
50-1024 \$11.95
- Proto-Sound 2.0 Battery Charger
50-1019 \$19.95
- TIU/TMCC-Legacy 6'
Connector Cable
50-1032 \$24.95
- 6' Mini-to-Mini Cable
50-1009 \$9.95
- 12-Port Terminal Block
50-1014 \$27.95
- 24-Port Terminal Block
50-1020 \$37.95
- Z-DC24 24-Watt Power Supply
50-240 \$17.95
- DCS 0 Gauge Companion
Digital Book - 2nd Edition
60-1279 \$12.95

WAY TO RUN A RAILROAD™

Command Control Explained

In conventional operation, an AC or DC transformer varies track voltage to adjust engine speed and direction. Command systems such as DCS, however, put a constant voltage on the track (around 18 volts for DCS) and vary speed by telling each engine how much of that voltage to use. Command control allows different engines to do different things — like run at different speeds, go in different directions, or make different sounds — even when they are on the same track.

In the DCS system, commands such as speed, direction, and sound control are sent as radio signals from the handheld throttle to a TIU (track interface unit). The TIU translates those radio signals into digital information that is sent through the rails and picked up by a receiver in the appropriate engine — telling it to go, for example, 37 miles per hour, blow the whistle,

smoke more heavily, or any other command. DCS locomotives can also send information back to the handheld to let the operator know what they're doing.



Learn More About It

Request a Complimentary DVD on DCS and M.T.H. technology. Log on to the DCS web site, www.protosound2.com

Try It at your local DCS Demo Center

Take your favorite Proto-Sound 2.0 or 3.0 engine to any DCS Demo Center and experience the additional features your engine has with DCS control. To find your nearest demo center or request your complimentary DVD, visit www.mthtrains.com.

M.T.H. Railroading App

Technology continues to expand in all aspects of our lives; we believe it must continue to do so in our products and our control systems if we want our hobby to remain relevant in the world of smart phones, tablets and wearable technology.

Why put a remote control in the hands of an operator when he or she probably has an even more powerful device in their pocket? Why shouldn't a modeler control their layout with their phone, when they can already use that phone to run their television, adjust their thermostat, and activate their home alarm system? More importantly, how many new members can we attract into our hobby when we bundle that hobby with technology they use every day?

Enter our first model railroading app

In 2015, M.T.H. will release smart phone and tablet apps that will allow operators to run their trains from Apple iOS or Android phones or tablets. That means your Apple iPhone or Samsung Galaxy can do one more thing we only dreamed about fifteen years ago when we introduced DCS. Your favorite Android tablet or Apple iPad will bring the DCS Digital Command



System to life in a way you never thought possible when you first picked up a DCS remote control. Any of these smart devices can run our new app. That means anybody who visits your layout can run trains — the days of fighting over the remote control are over!

Whether you're running Android or iOS, our DCS app will allow you to control your entire layout in command or conventional modes without using a DCS handheld remote. You'll still need a TIU (Track Interface Unit) along with a new, separately sold DCS WiFi module.

Simply plug the module into the TIU, search for its WiFi signal on your phone or tablet, and you'll be running your layout in command mode in no time. Everything the DCS handheld remote can do, the app can do — but your experience will be better and in full color!

Our new app isn't limited to just DCS control either. With it, you'll be able to access special pages on the M.T.H. website, see the latest catalogs and news articles, and shop for M.T.H. products. Look for the app this year — it's gonna be fun.

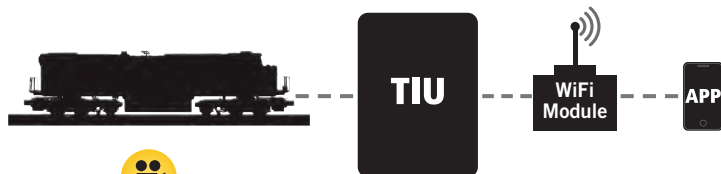

See a Demo at www.mthtrains.com

What Can Your Remote Do?

DCS COMMANDER

HO DIGITAL COMMAND SYSTEM CONTROLLER

More Features Than Analog DC or DCC Command Control Run Up To 10 Engines At Once!

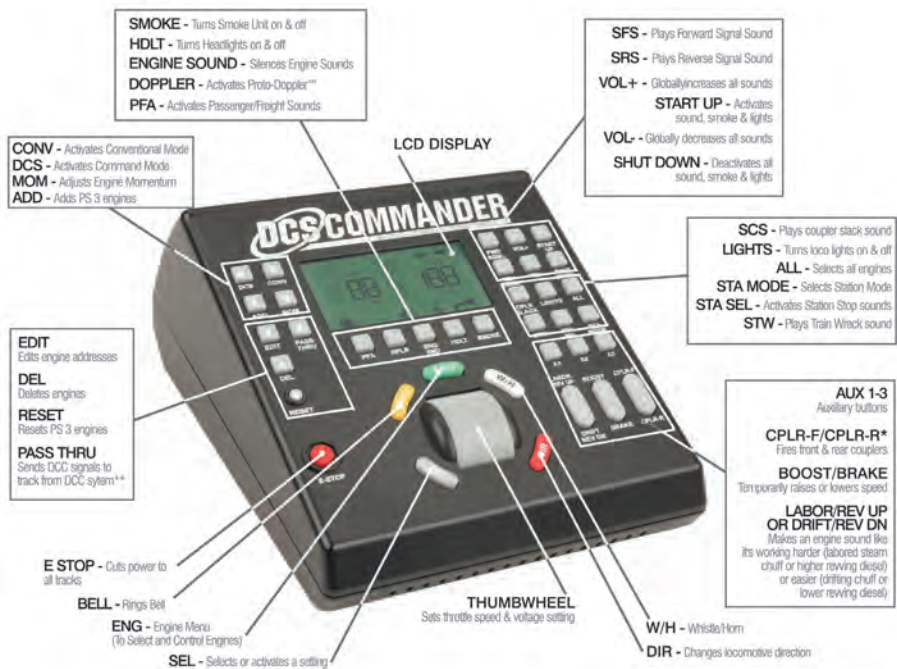

* Operating couplers are not available on HO locomotives at this time.
 ** Customer supplied DCC system Required

The next generation of the DCS Digital Command System is here. The all-new DCS Commander brings a less expensive, but powerful command control device to your O Gauge and HO DC powered layouts. Connect a DCS Commander between the wires of your existing DCC system or DC power supply to the track and you can switch back and forth between DCS and Analog DC operating modes with just a push of a button.

Because M.T.H. Proto-Sound 2.0 or 3.0 locomotives can operate on both AC or DC current, the DCS Commander may be the affordable DCS command control option you've been looking for. Available alone or bundled with a 100 watt power supply, The DCS commander outputs 18 volts of DC power and includes

a built-in 5amp resettable breaker making it a perfect solution for small M.T.H. O Gauge layouts exclusively running Proto-Sound 2.0 or 3.0 locomotives.

For HO operators, the DCS Commander Controller Set is a perfect power solution for almost any size HO layout. HO operators whose layouts are already outfitted with a DC power supply can choose the individual DCS Commander and plug their existing power supply right into the Commander's power inputs.

The DCS Commander provides the user with intuitive control of multiple Proto-Sound 2.0** or later equipped locomotives. For each locomotive, more than 32 functions are available at the touch of a single clearly-labeled button.



Perfect for Any Proto-Sound 2.0 or 3.0 Equipped Train Set!

DCS Commander System
w/100 Watt Power Supply
50-1029 \$259.95

DCS Commander Controller
50-1028 \$179.95

Features Include:

- Speed adjustment in one-scale mile-per-hour steps
- Independent feature control: tune your engines' sound, lights, smoke and acceleration/deceleration settings
- Smoke On/Off
- Doppler Sounds: simulate the classic sound effect of a train approaching and then whizzing past
- Accent Sounds: activate any one of 7 individual sounds, including signal forward and reverse sounds, coupler slack, engine start-up and shut-down, engine labor and engine drift
- Activate Passenger Station and Freight Yard Sounds
- Individual locomotive control: select up to 10 Proto-Sound 2.0 or later engines
- Selectable control mode configurations: choose between analog DC, DCC and DCS operating modes
- Track Signal Test: test your layout's signal strength using the built-in signal strength analyzer.
- Proto-Whistle Quillable Sound Activation: access the built-in Proto-Whistle quillable sounds*** found inside your Proto-Sound 2.0 or later locomotives and using the thumbwheel to "play" your locomotive's whistle just like a real engineer!
- Access Whistle Signal Sounds: activate grade crossing whistle signals**** on your Proto-Sound 2.0 or later equipped locomotive

** Requires Proto-Sound 2.0 locomotive onboard 3-volt system or Proto-Sound 3.0 locomotive onboard system. Proto-Sound 2.0 3-volt systems are identified by their square battery charging jack on the locomotive chassis. See the locomotive's operator's manual for the exact location of the charging jack.

*** Proto-Whistle quillable sounds not found in all Proto-Sound 2.0 or later equipped locomotives. Refer to your locomotives operator's manual to determine if your locomotive is equipped with Proto-Whistle quillable sounds.

****Proto-Whistle grade crossing signals not found in all Proto-Sound 2.0 or later equipped locomotives.

DCS Remote Commander Set

The DCS Remote Commander is an inexpensive wireless solution capable of accessing the most popular command control functions programmed into Proto-Sound 2.0 or 3.0 locomotives. The DCS Remote Commander handheld controller features clearly labeled, one-button control of 9 engine functions. There are no function keys or special codes to remember. Access the locomotive whistle or horn, bell, smoke, direction and speed with just a single button push. You can also access Passenger Station or Freight Yard Proto-Effects, engine startup and shutdown sounds and control the front or rear Proto-Couplers with this lightweight, easy-to-use remote.

Adding a DCS Remote Commander to your existing layout is simple: just plug your power supply into the DCS Remote Commander receiver and the output wires from the receiver to your track lockon. The DCS Remote Commander can accept any power input (AC or DC) up to 20 volts and 8 amps, making it a perfect choice for small and moderately sized layouts.

DCS Remote Commander Set
50-1033 \$59.95

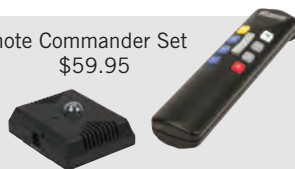

Features Include:

- Speed adjustment in one-scale-mile-per-hour steps
- Volume Control
- Smoke on/off
- Front & Rear Proto-Coupler Control
- Engine Start-up & Shutdown Sounds
- Activate Passenger Station and Freight Yard Sounds
- Whistle/Horn Control & Bell On/Off
- Locomotive Direction Control
- Wireless Communication With DCS Remote Commander Receiver
- LED Power On Lamp (Receiver Only)
- AC or DC Power Input
- Remote Requires (2) AA Batteries (not included)
- Unit Measures: 6 inches

MTH Railroaders Club

JOIN THE CLUB

There are **TEN** different types of memberships, based on the style of model railroading that most interests you.

JOIN ONLINE! IT'S EASY - JUST GO TO WWW.MTHTRAINS.COM

RailKing Membership



30-76645 MTHRC Husky Stack Car
RailKing Membership is \$50.00

Tinplate O Gauge Membership



10-8087 MTHRC No. 2817 O Gauge
Illuminated Caboose
Tinplate 2800 Series Membership is \$90.00

Lionel Corp. O Gauge Membership



11-70155 Lionel Corporation
No. 2817 O Gauge Illuminated Caboose
Lionel Corp. 2800 Series Membership is \$90.00

One-Gauge Membership



70-75051 Norfolk Southern 4-Bay Hopper Car
One-Gauge Membership is \$100.00

Basic Membership

60-1000 - The Basic Club Membership does not include a club car
Basic Membership is \$25.00

90

Premier Membership



20-97841 Norfolk Southern 4-Bay Hopper Car
Premier Membership is \$55.00

Tinplate Std. Gauge Membership



10-2247 MTHRC No. 217 Std. Gauge
Illuminated Caboose
Tinplate 200 Series Membership is \$120.00

Lionel Corp. Std. Gauge Membership



11-30233 Lionel Corporation
No. 217 Std. Gauge Illuminated Caboose
Lionel Corp. 200 Series Membership is \$120.00

HO Membership



85-74136 MTHRC 40' PS-1 Box Car
HO Membership is \$30.00

S Gauge Membership



35-74016 Long Island Rebuilt Steel Box Car
S-Gauge Membership is \$55.00

AS A MEMBER OF THE M.T.H. RAILROADERS CLUB YOU'LL RECEIVE:



Limited-Edition Club Car



Each year we produce beautifully decorated cars exclusively for our Club members. Members automatically receive the car that matches their Club membership (RailKing, Premier, Tinplate, S Gauge, HO, or One Gauge) and have the option to collect the other Club cars as well.

The CrossingGate™ Club Magazine

You will receive our quarterly full color Club magazine, jam-packed with product news, layout visits, rail history, and step-by-step articles on how to enjoy M.T.H. products even more.



1st Class Mailing of M.T.H. Catalogs

Club Members get all of our catalogs earlier than all our other mailing list members, via First-Class mailings, so they can order from their local train store before the best items are sold out.



RailWare™ Software DVD



Use your computer to design track layouts, search the database of all M.T.H. products, look at our past catalogs, listen to Proto-Sound 3.0 train effects, and much more. This DVD retails for \$79.95, but is yours FREE as a Club member.

Unique Club Products and Discounts



You'll have the option to purchase uncataloged members-only engines and rolling stock, and take advantage of members-only discounts on select cataloged items.

Club Card & Lapel Pin



Show the world your membership in this elite group of model railroaders with your high-quality embossed membership card and beautiful enameled lapel pin.

Proto-Sound@ 3.0 Upgrade Kits

Club members can save an additional 15% on these kits for upgrading older locomotives.

Club Web Site

Visit www.mthtrains.com & type in your member number to gain access to the Club web site. Here you can exchange messages with other Club members, and even build your own homepage.

CARRY ON THE M.T.H. TRADITION WITH MEMORABILIA AND COLLECTIBLES

MTH Promotional DVD

This interactive DVD is packed full of sights & sounds guaranteed to make you rethink how far the hobby of model railroading has come. You'll learn about some of the most innovative products ever produced and marvel at the sophistication of a product line unmatched by other model train manufacturers.

Previous Year Club Cars

MTHRRC members can still obtain earlier produced MTHRRC cars by visiting the MTHRRC pages on the website. Only MTHRRC members can get these cars!



A Toy Train Story

This comprehensive history of M.T.H. is a must for toy train hobbyists. 350 pages & 1900 color photos, hard cover. Add this book to your membership for only \$25.00 (50% off the \$49.95 cover price!)



www.mthtrains.com

We don't think we're exaggerating when we say M.T.H. has the most useful train manufacturer's site on the Internet. Here's just a sample of the answers you can find online.



WHAT'S THE LATEST INFO ON ...?

Use Product Search to find the latest info on new products before they're delivered — sound sets, cab numbers, feature and paint scheme updates, and other information that arrived after the catalog was published.

DID YOU EVER MAKE?

Use Product Search to search through nearly all of the 15,000 items we've made in the past 33 years, for your favorite road name, engine, or type of rolling stock.

HOW DOES IT WORK?

Misplaced an instruction manual or just want to know how a product works? Use Product Search to look up the item and view its instruction manual.

DOES ANY DEALER STILL HAVE ...?

Locate hard-to-find items with our Product Locator, which searches the inventories of M.T.H. dealers across the country.



WHEN IS IT COMING?

Our online Shipping schedule is updated frequently to let you know what's coming soon to your hobby shop.

ARE YOU GOING TO MAKE?

View the last several M.T.H. Catalogs online. Or click on Video to see M.T.H. products in action.

HOW CAN I FIX...?

The Service area of our site allows you to email a question to our factory technicians or find which of our 150+ local service centers is closest to you.

WHAT REPAIR PART DO I NEED?

Use Product Search to find exploded diagrams and parts lists for M.T.H. locomotives and accessories, and then order the parts online or by phone.



WHAT'S NEW?

New arrivals and other news are posted frequently on our home page.

HOW CAN I LEARN MORE ABOUT DCS?

Follow the link to the protosound2.com Web site for DCS and Proto-Sound information — and a list of Authorized DCS Demo Centers where you can try DCS hands-on.

HOW CAN I UPDATE MY DCS SYSTEM OR CHANGE A SOUND SET?

Only M.T.H. allows you to update your control system or change an engine's sound set right over the Internet. Follow the link to the protosound2.com Web site for DCS and Proto-Sound 2.0 downloads.

To get the news as it happens, sign up for our free weekly electronic newsletter, with information on new M.T.H. products, industry news, and sneak peeks at upcoming specials!
Just go to mthtrains.com and click on Newsletter Signup.

Not all products depicted in this catalog are production models. In some cases, the items pictured may be HO, O Scale or some other scale product.

All item's graphic features and content are subject to change after publication. All product features may be verified on their retail packages. M.T.H. Electric Trains is in no way affiliated with any of the railroads featured in this catalog.

©2016, M.T.H. Electric Trains,
7020 Columbia Gateway Drive
Columbia Maryland 21046-1532
www.mthtrains.com - (410) 381-2580

MTH Trademarks: M.T.H. Electric Trains®, M.T.H.®, MTH Railroaders Club™, Ives®, Loco-Sound™, Proto-Sound® 2.0, Proto-Speed Control™, Proto-Doppler™, Proto-Dispatch™, Proto-Cast™, ProtoSmoke™, Proto-Coupler™, Proto-Effects™, Proto-Scale 3-2™, RailKing®, Rugged Rails®, RailKing One-Gauge™, RailTown™, Tinsplate Traditions™, ScaleTrax™, RealTrax®, Z-500™, Z-750™, Z-4000®, Z-1000™, Z-4000, DCS ...simply the best way to run a railroad

™, Remote Commander™, DCS™ and the MTH Numbering System and all others indicated throughout this catalog. RealTrax® layouts created with RR-Track™ which is a registered trademark of R&S Enterprises.

Greyhound is a registered trademark of the Greyhound Lines, Inc.

©2016 MillerCoors, LLC. All rights reserved. Produced under license by M.T.H. Electric Trains. This licensed product is intended for adults of legal drinking age.

"Products bearing Southern Pacific, Denver & Rio Grande, Pacific Fruit Express and Union Pacific marks are made under trademark license from Union Pacific Railroad Company."

Lionel is a registered trademark of Lionel Trains LLC. FasTrack™, TMCC®, TrainMaster®, CAB-1® Remote Controller, and Lionel® are all registered trademarks owned by Lionel L.L.C. All Rights Reserved.

M.T.H.'s DCS Digital Command System has received U.S. Patent No. 6,457,681. M.T.H.'s Proto-Sound 2.0 system has received U.S. Patent No's 6,457,681 B1 (sound system), 6,457,681 B1 (Proto-Speed Control), 6,604,641 (Proto-Coupler), 6,280,278 (Proto-Smoke). M.T.H.'s RealTrax has received U.S. Patent No. 6,019,289. M.T.H.'s ScaleTrax switches have received U.S. Patent No. 6,491,263.

M.T.H.'s Z-4000 Transformer has received U.S. Patent No's. 6,281,606 & 6,624,537.

M.T.H.'s Proto-Scale 3-2 has received U.S. Patent No. 6,662,917
Some images used in this publication ©2016 www.clipart.com



WiFi



**Simply the
Best Way
to Run a
RailRoad™**

View Our Full 2016 Lineup Online



Go to www.mthtrains.com
and click on "Catalogs"

WWW.MTHTRAINS.COM

© 2016 M.T.H. Electric Trains
7020 Columbia Gateway Drive, Columbia, Maryland 21046

