

What's New?

What's an imaginary beer train doing on the cover of our catalog? As much as anything on these pages, it exemplifies what we try to do at M.T.H.: listen to you, be original, and have fun. Over the past two years, more of you have requested a model of The Silver Bullet® than any other train. This catalog is also full of prototypical new models and road names that many of you have asked for — including many items that have never been made before in three-rail O gauge. We hope each of you will find something in this catalog that you've always hoped we'd make.

Most important, we hope you'll have fun with our products. This is, after all, a hobby; it's supposed to be an escape from your daily concerns. Especially in O gauge, fun comes in many flavors, and we've tried to address them all in our product lines: pure fantasy trains, semi-realistic toy trains, and extremely accurate scale models. Here's a quick preview of what's new.

WHAT'S NEW IN THIS CATALOG

With The Silver Bullet®, we're introducing a feature that has been latent in Proto-Sound® 2.0 but never used before: the

ability of a locomotive to "talk to" its trailing cars or track-side accessories. In the future, you'll see innovations such as trains that tell a station to announce their arrival or engines telling each other their locations to coordinate operations.

As always, this catalog announces new models we've never offered before. In the RailKing line, you'll find a scale-proportioned SW1 diesel switcher, a New York City Q-type subway car, and the 6000-series "L" car that Chicago modelers have requested for some time. As a result of a new agreement with the H.J. Heinz Company, Heinz freight cars appear in the RailKing and Premier lineups.

The list of new Premier models is more extensive. In steam you'll find a massive Northern Pacific Challenger, a USRA 0-6-0, a Pennsy L1 Mikado, and a new radial boiler version of our tiny 0-4-0. The Alco-GE-Ingersoll Rand boxcab, widely recognized as history's first successful diesel, also joins the Premier line,

along with the General Electric U30C, the North Shore Electroliner, and the Virginian Railway EL-3A electric, the most powerful locomotive in the world when it was built in 1925. We've also cataloged the Union Pacific Heritage scheme diesels you've been asking for, a new fishbelly hopper, and Twin Stack container trains.

WHAT'S NEW IN DCS

The M.T.H. Digital Command System (DCS™), in conjunction with Proto-Sound® 2.0, remains the only train control system with two-way communication, so your locomotives can send as well as receive information. As mentioned earlier, The Silver Bullet® is just the first of many trains that will use two-way communication to offer exciting new features.

DCS™ also remains the only command system you can upgrade over the Internet — for free. We're working on the next software

upgrade to give you more of the capabilities you've requested. Features like lashups in TMCC® (Lionel® Trainmaster® Command Control) and control of all speed steps in locos equipped with the TrainAmerica Studios Engineer on Board (EOB) are being reviewed. DCS™ is still the only command system compatible with locomotives from all major O gauge manufacturers.

WHAT'S NEW IN THE SOUND DEPARTMENT

Throughout the M.T.H. line, we're working to give you bolder, more realistic sound systems. Inside our engines, we're improving sound reproduction with new speakers and sealed speaker chambers for better low frequency response. Onboard memory will be doubled so we can give you better sound quality and more variety in each sound set.

We're also constantly upgrading and expanding our sound library. Over the summer of 2006, for example, we added new recordings of several Leslie and Nathan diesel air horns, as well as new Alco and Baldwin prime mover sounds. Some of our older

sound sets, such as the Electro Motive SD40, GP40, and GP30, have been replaced with new recordings. As this catalog was being prepared, our sound engineers were on location in the Southwest making new recordings from a variety of General Electric and EMD diesels for our newest models.

WHAT'S NEW ON THE WEB

We've continued to add new features and content to www.mthtrains.com. If you're signed up for our weekly emails, you've probably read the first installments of "DCS Tips & Techniques," an occasional series that we hope will increase your enjoyment of the M.T.H. Digital Command System. In these brief articles we point out and clarify DCS features that will make your Proto-Sound® 2.0 (and TMCC®) locomotives more fun, more realistic, and more interesting to operate. The ongoing series and additional DCS™ content are archived on the protosound2.com area of our Web site.

Beginning with this catalog, our site will also contain additional prototype information that expands on our catalog descriptions. In the product descriptions of selected items, you'll find a link to a prototype article that appears with the permission of the original publisher.

We invite you now to turn the page and see for yourself what's new. As always, we hope you'll find items in this catalog that will surprise and delight you, and help you continue to enjoy this most wonderful of hobbies.



WWW.MTHTRAINS.COM

Table of Contents

Proto-Sound® 2.0	2
DCS	4
RailKing	6
Steam	6
Diesel	20
Electric	34
Subway	36
Freight	42
Passenger Cars	70
Premier	74
Steam	76
Diesel	92
Electric	124
Transit	126
Freight	130
Freight Sets	160
Passenger Cars	164
Transformers	169
Accessories	170
M.T.H. RailRoaders Club	174
Mega Stations	176
MTH Online	177



PROTO-SOUND® 2.0...

THE RICHEST SET OF FEATURES IN MODEL RAILROADING!

Whether you operate with a conventional transformer or in command mode with DCS™ (M.T.H.'s Digital Command System), the Proto-Sound® 2.0 system found in every locomotive in this catalog offers more realism, more fun, and more variety than any other locomotive control system in any scale.

VIVID ENGINE SOUNDS

Proto-Sound® features digital recordings with CD-quality playback. We strive to make our sounds as authentic as possible, using the characteristic whistle for a particular steam engine, for example, and the correct prime mover sound for each manufacturer's diesels. With the optional DCS™ system, you can tune each engine to your preference by individually adjusting bell, horn or whistle, and chuff or diesel motor volume.

STATION SOUNDS

Proto-Sound® passenger engines offer Passenger Station Proto-Effects™, a complete arrival and departure sequence that you can activate from your transformer* or DCS™ handheld. In most cases, the station sequence features an actual name train pulled by that particular engine. Freight engines include Freight Yard Proto-Effects™, a symphony of freight terminal sounds.

ATMOSPHERIC SOUNDS

Crew conversations, the whoosh of a steam engine opening its cylinder cocks, and a host of other atmospheric sounds play automatically at random when using a conventional transformer - or can be activated manually from the DCS™ handheld.

EXTRAORDINARY SLOW SPEED CAPABILITY

Proto-Sound® engines can throttle down as slow as three scale miles per hour, highball down the main line, and maintain any speed in between. In DCS™ mode you can set engine speed in one-scale-mile-per-hour increments up to 120 smph.

SPEED CONTROL

The Proto-Speed Control™ built into Proto-Sound® 2.0 acts like the cruise control on a car, keeping your train moving at the speed you select, regardless of hills and curves. You can even switch off the speed control if you prefer.

MULTIPLE UNIT CAPABILITY

In DCS™ command mode, all locomotives set to the same speed - 37 scale miles per hour, for example - will move at virtually the same speed. This makes it easy to double or even triple-head nearly any combination of Proto-Sound® 2.0 locomotives.

LIGHTING EFFECTS

Proto-Sound® locomotives feature a variety of prototypical lighting effects. Depending on the locomotive, these may include constant-brightness headlights, illuminated number boards, marker lamps, firebox glow in many steam locomotives, and operating Mars lights or oscillating ditch lights (where appropriate) on diesels. In DCS™ operation, many of these lighting effects can be individually controlled.

GREAT SMOKE

Proto-Sound® steam engines and diesels feature fan-driven ProtoSmoke™, the most powerful smoke system in the hobby. You can vary the intensity with the smoke "volume" control on the locomotive or remotely with a DCS™ handheld.

SYNCHRONIZED CHUFF AND PUFF

Like a real steam engine, M.T.H. steamers feature puffs of smoke and steam chuff sounds synchronized with the drive wheels. Better than any other model train, an M.T.H. locomotive portrays the drama of a steam engine slowly chuffing and puffing as it pulls out of a station and gets up to speed.

BRAKE SOUNDS

Engine brakes squeal whenever you throttle back sharply or pull into a station. In DCS™ mode, you can trigger the brake sound with the Brake button on the DCS™ handheld.

OPERATE 'EM ALL

In DCS command mode, unlike any other command system available today, you'll have one-touch control over every Proto-Sound® 2.0 equipped locomotive at the same time. Imagine, with the ALL command, your DCS™ system will start-up every locomotive at the same time!

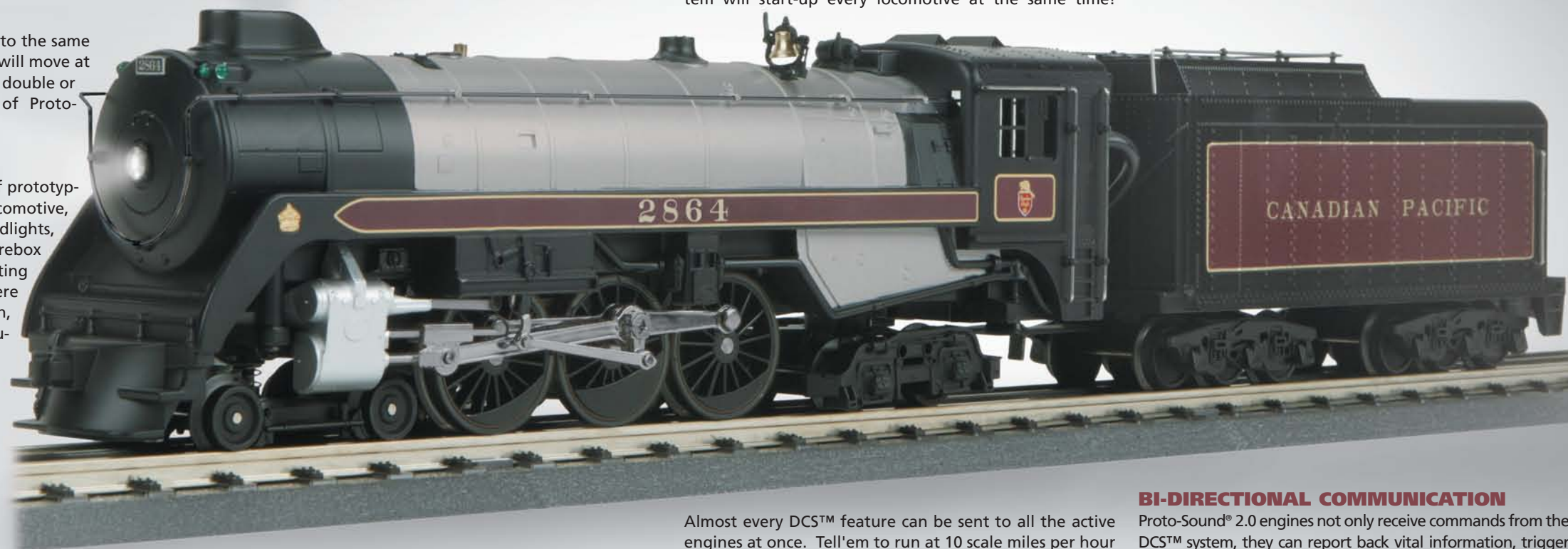

Almost every DCS™ feature can be sent to all the active engines at once. Tell'em to run at 10 scale miles per hour and they'll all start moving at the same time and at the same speed. Blow all their horns at once, turn on or off their smoke, stop and reverse every active engine all at the same time.

UPDATED ENGINE FEATURES

Using a DCS™ system, any Proto-Sound® 2.0 engine can be updated with new sounds or features without ever taking the engine apart or even off the track. Simple

downloads of new Proto-Sound® sound sets from the M.T.H. website mean your engine will never be obsolete. It can change from a passenger train to a freight train or get a new whistle or horn in just minutes.

BI-DIRECTIONAL COMMUNICATION

Proto-Sound® 2.0 engines not only receive commands from the DCS™ system, they can report back vital information, trigger other devices to operate and diagnose your layout's wiring and signal quality. Imagine querying a Proto-Sound® 2.0 locomotive to find out how many scale miles it's run or how many hours it's been powered up. How about checking out the strength of the DCS™ signal on the track or measuring the track voltage at a trouble spot? What about learning how long your track is in scale miles? All of this is possible today, but only in a Proto-Sound® 2.0 equipped locomotive when operated using the DCS™ Digital Command System.



Premier vs. RailKing

In this catalog you'll find two M.T.H. product lines, Premier and RailKing. While they differ in detail level and price, under the shell they're very much the same. Every engine in this catalog shares the same Proto-Sound® 2.0 electronics and the same quality M.T.H. construction. Premier and RailKing engines can be run together on your railroad in conventional or DCS™ command mode.

Premier engines are full O scale models, 1/48 the size of their prototypes. Because of this, they often require larger radius curves than comparable RailKing models. Premier engines are as detailed as we can reasonably make them, and feature a large number of added-on details. On Premier steamers, for example, most piping is separately applied, whereas most piping on RailKing steam engines is cast onto the boiler. While smoke is standard on virtually all M.T.H. steamers, only Premier and RailKing Scale diesels feature smoke. Premier engines also have more elaborate lighting effects.

RailKing models have less detail and are lower priced than their Premier counterparts. Unless otherwise noted, all RailKing engines will negotiate O-31 curves. While RailKing Scale engines are full O scale size, other RailKing engines may have smaller proportions than their prototypes, to make them appropriate for smaller layouts and O-31 curves. RailKing Imperial models are our top-of-the-line RailKing engines, with features such as real coal loads and separately illuminated marker lamps.



SIMPLY THE BEST WAY TO RUN A RAILROAD™

There is a new way of controlling model railroads today that you've got to see to believe. It's called DCS™ (for Digital Command System) and it's the most revolutionary product to hit model railroading since locomotives first became equipped with sound!

Unlike traditional or conventional means of operating a model railroad, command systems allow the user to independently control each engine even if other engines are on the same track at the same time. The concept has been around since the early 1990's, but only DCS makes it simple and easy to use — thanks to its state-of-the-art technology and intuitive interface.

Upgrading to DCS unlocks more features than you'll find in any other command control operating system — features that are factory-installed in every Proto-Sound® 2.0 locomotive. Here's just a partial list of what DCS offers:

WIRELESS HANDHELD THROTTLE
Run your whole railroad — locomotives, accessories, everything — from one or more DCS handheld remotes. An LCD screen indicates which engine you're controlling and its current speed, adjustable in one-scale-mile-per-hour increments. Program engines and accessories on the same screen. For nighttime operation, turn on the screen's backlight.

COMMAND CONTROL
Operate up to 99 DCS-equipped engines independently at the same time on the same electrically continuous track — using one or several DCS wireless handheld remotes. When you have guests, give each visitor a DCS handheld and let them control their own engine. Just like the prototype, you can double-head locomotives, add or drop helper engines, or bring a train into the station with a mainline engine and then have a switcher break up the consist.

PROTO-SOUND® 2.0 ENGINE SOUNDS
DCS offers individual control of dozens of sounds built into every M.T.H. locomotive. Rev the diesel motor up manually before moving your train. Activate auxiliary sounds such as steam letoff and

crew conversations. Whistle, bell, and steam chuff or diesel prime mover sounds even have independently adjustable volume control.

TRAIN SOUNDS
Add ambience to your railroad with the variety of train sounds built into Proto-Sound® 2.0. The DCS handheld gives you access to effects such as wheel clickety-clack, coupler opening sounds, and the Doppler effect of a train passing by. DCS also offers one-button activation of the Passenger Station or Freight Yard Proto-Effects™ built into every Proto-Sound® 2.0 locomotive.

SMOKE CONTROL
Adjust the smoke intensity for a steam or diesel engine at any time from the DCS remote.

CONSTANT LIGHTING
Because DCS operates with a constant voltage on the rails (most operators use 18 volts), engine, caboose, and passenger car lights are always on at a constant intensity. No more "lights-out" when a passenger train arrives at a station!

PROGRAMMABLE OPERATION
Record up to 90 minutes of DCS speed, direction, and sound commands as a program that your engines can repeat on demand. Use this



feature to run trains automatically on one part of your railroad while you manually control another area.

UPGRADABLE SOFTWARE
Unlike any DCC or any other command system, DCS is designed to be upgradable over the Internet. The latest software can be downloaded to any DCS system ever made, so new features can be added and your investment will not become obsolete.

TMCC® COMPATIBILITY
Add a Lionel® Command Base to your DCS system and you can run engines equipped with TMCC® (Lionel's TrainMaster® Command Control) side-by-side with DCS engines - all from the DCS handheld controller. If you prefer, you can even use a Lionel CAB-1® handheld to control TMCC engines at the same time you're controlling Proto-Sound engines with the DCS controller.

LISTEN TO YOUR FAVORITE TUNES WITH PROTO-CAST™
DCS is the only command control system that lets you hook up any audio source and play your favorite music right through the train!

BE YOUR OWN DISPATCHER
With DCS's built-in remote microphone, real-time radio dispatch calls are just a button push away.

COMMAND CONTROL EXPLAINED

In conventional operation, an AC or DC transformer varies track current to adjust engine speed and direction. Command systems such as DCS™, however, put a constant voltage on the track (around 18 volts for DCS) and vary speed by telling each engine how much of that voltage to use. Command con-

trol allows different engines to do different things - like run at different speeds, go in different directions, or make different sounds - even when they are on the same track.

In the DCS system, commands such as speed, direction, and sound control are sent as radio signals from the handheld throttle to a TIU (track interface unit).

The TIU translates those radio signals into digital information that is sent through the rails and picked up by a receiver in the appropriate engine - telling it to go, for example, 37 miles per hour, blow the whistle, smoke more heavily, or any other command. DCS locomotives can also send information back to the handheld to let the operator know what they're doing.

DCS WIRELESS REMOTE HANDHELD

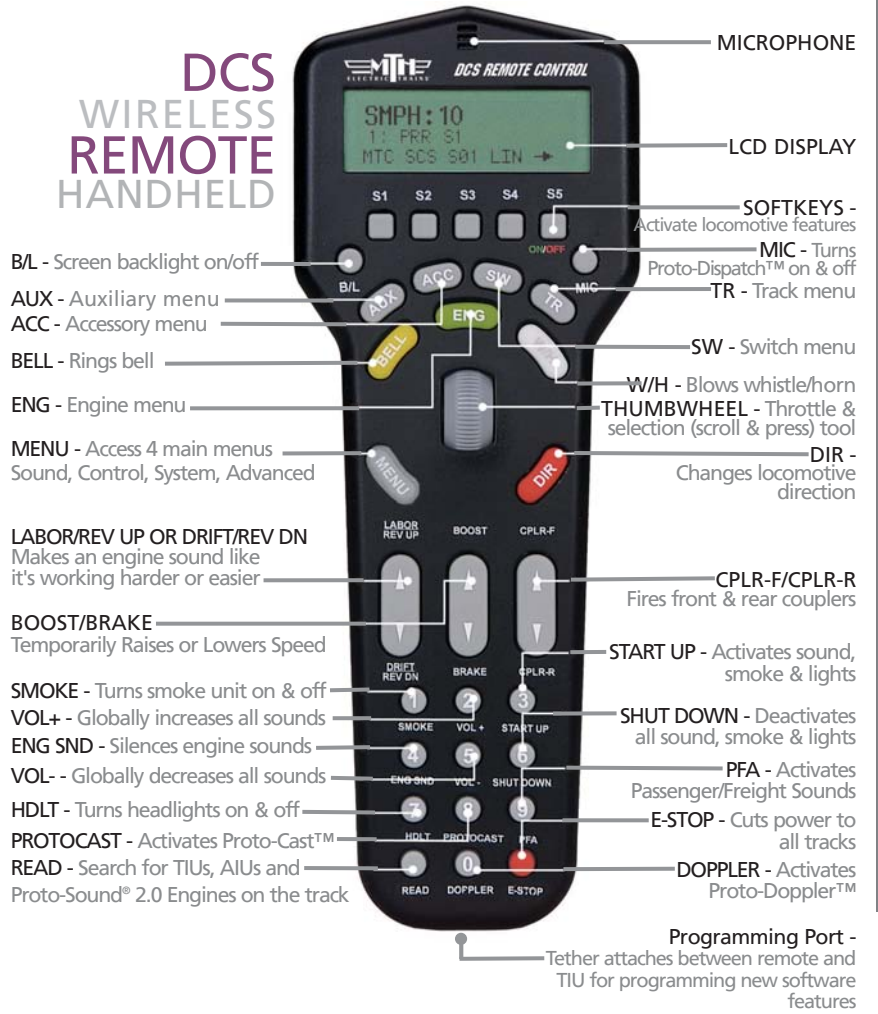

INTUITIVE MENUS ALLOW YOU TO PROGRAM, SELECT, AND CONTROL ENGINES, SWITCHES, AND ACCESSORIES.

- Go to the engine set up menu
▶ ADD ENGINE
EDIT ENGINE
DELETE ENGINE
MENU:ENGINE SETUP
- Choose your engine type
▶ ADD MTH ENGINE
ADD TMCC ENGINE
MENU:ADD ENGINE
- DCS will "look" for Proto-Sound® or TMCC command-equipped engines on your layout. When it finds one, it adds it onto your remote and tells you when it's done.
CONGRATULATIONS
YOU SUCCESSFULLY
ADDED AN MTH ENGINE
SMPH: 10
1: PRR S1
MTC SCS S01 LIN →

- DCS Remote Control System 50-1001 \$299.95
- DCS Remote Control - Handheld Unit 50-1002 \$149.95
- DCS Track Interface Unit (TIU) 50-1003 \$179.95
- DCS Accessory Interface Unit (AIU) 50-1004 \$99.95
- TIU/Barrel Jack Adapter Cable 50-1017 \$9.95
- TIU/TMCC 6' Connector Cable 50-1018 \$19.95
- 6' Mini-to-Mini Cable 50-1009 \$9.95
- AA NiCad Proto-Sound® Battery 50-1024 \$9.95
- Proto-Sound® Battery 50-1008 \$9.95
- Proto-Sound® 2.0 Battery Charger 50-1019 \$14.95
- 24-Port Terminal Block 50-1020 \$29.95
- 12-Port Terminal Block 50-1014 \$19.95
- 100-Watt Accessory Power Supply 40-1000A \$79.95

4 Every Proto-Sound® 2.0 Locomotive is Already Equipped to Run DCS!



4-6-4 Dreyfuss Steam Engine

IMPERIAL
SERIES



As public interest in aerodynamics increased in the 1930s, the railroads faced pressure to be--or at least look--faster and more modern. Their answer was the streamliner, a smooth cover for the utilitarian and bulky steam engine. Henry Dreyfuss's 1938 design for the New York Central's Hudson was one of the twentieth century's most successful efforts at streamlining a steam engine. Rather than replicating the shroud-like drapes previous designers had used to cover, and try to disguise, the steam engines, Dreyfuss chose to work with the lines of the engine itself. He left most of the lower running gear exposed to make routine maintenance easier to perform, and he kept the shape of the cover close to the engine's body. It was his elegant, sleek touches--the spherical front, covered domes, and extended tender--that gave this handsome streamliner its distinctively modern look and made it the symbol of the NYC, used in emblems and advertising for years to come.

Did You Know?

Ten J-3 Hudsons, numbered 5445-5454 were given the distinctive Dreyfuss shrouding.



New York Central - 4-6-4 Dreyfuss Steam Engine
30-1443-1 Proto-Sound® 2.0 \$429.95

Features

- Die-Cast Metal Chassis
- Authentic Paint Scheme
- Metal Wheels and Axles
- Precision Flywheel Equipped Motor
- Metal Handrails and Decorative Bell
- Real Coal Load
- Decorative Metal Whistle
- Die-Cast Boiler and Tender Body
- Constant Voltage Headlight
- Die-Cast Truck Sides
- Remote Controlled Proto-Coupler™
- Locomotive Speed Control
- Engineer and Fireman Figures
- Operating Firebox Glow
- Synchronized Puffing ProtoSmoke™ System
- Operating Tender Back-up Light
- Proto-Sound® 2.0 With The Digital Command System Featuring Passenger Station Proto-Effects™
- Unit Measures: 21 1/4" 2 1/2" x 3 3/8"
- Operates On O-31 Curves



New York Central - 4-Car 60' Streamlined ABS Passenger Set
30-67344 \$199.95

2-8-4 Berkshire Steam Engine

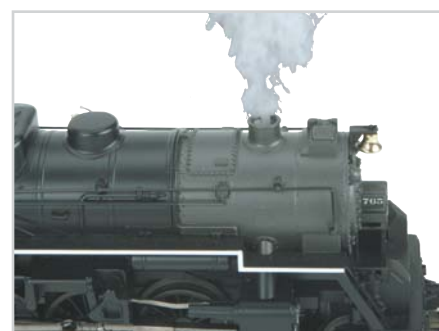

In the 1920s, increased competition meant that railroads had to come up with new ways of doing business if they hoped to remain successful. Up to that time, most freight was moved by connecting as many cars as possible to a locomotive and having the steam engine heave and drag them along (called "drag freight"). Some railroads decided to compete more effectively by increasing the speed, not the capacity, of their freight trains. The Lima Locomotive Works' 2-8-4 Berkshire steamer, introduced in 1924 and named for the Massachusetts mountains where it was demonstrated, helped make this happen. The Berkshire was dubbed a "Super Power" engine because its larger firebox grate and other related elements (which necessitated the 4-wheel trailing truck) greatly increased the engine's steam-making capacity. And more steam capacity means more power and more speed. In all, 611 Berkshires were built for several railroads. They were a huge success and remained in service on U.S. rails until 1958, well into the diesel era.

MTH is pleased to offer the RailKing Berkshire in four new roadnames: Nickel Plate Road, Chicago NorthWestern, Richmond Frederick & Potomac and Santa Fe.

Did You Know?

The first 2-8-4 was built with 63" drivers, but railroads soon discovered that it had so much more steam capacity than previous freight engines it could power larger - and therefore faster - drivers, and subsequent models had 69"-70" drivers. Cruising speeds averaged about 55 mph.



Chicago & North Western - 2-8-4 Berkshire Steam Engine
30-1434-1 Proto-Sound® 2.0 \$399.95



Richmond Fredericksburg & Potomac - 2-8-4 Berkshire Steam Engine
30-1436-1 Proto-Sound® 2.0 \$399.95



Santa Fe - 2-8-4 Berkshire Steam Engine
30-1437-1 Proto-Sound® 2.0 \$399.95



Nickel Plate Road - 2-8-4 Berkshire Steam Engine
30-1435-1 Proto-Sound® 2.0 \$399.95

Features

- Die-Cast Metal Chassis
- Authentic Paint Scheme
- Metal Wheels and Axles
- Precision Flywheel Equipped Motor
- Metal Handrails and Decorative Bell
- Decorative Metal Whistle
- Die-Cast Boiler and Tender Body
- Constant Voltage Headlight
- Die-Cast Truck Sides
- Remote Controlled Proto-Coupler™
- Synchronized Puffing ProtoSmoke™ System
- Locomotive Speed Control
- Engineer and Fireman Figures
- Proto-Sound® 2.0 With The Digital Command System Featuring Freight Yard Proto-Effects™
- Unit Measures: 22 1/2" x 2 1/2" x 3 3/8"
- Operates On O-31 Curves

2-8-8-2 Y6b Steam Engine



The first modern design steam engine on the Norfolk and Western, the Y-6 class was an awesome figure on the popular railroad. The Y6b engine, called the "workhorse of the N&W," was particularly well suited to mountain terrain, and its engineers said it was unstoppable as it labored its way up a grade. Often used to power coal trains, the Y6 and improved Y5 class engines packed so much power they were rated at only two locomotives for a 10,300 ton load on the tough Radford Division eastbound Allegheny climb. Weighing more than 600,000 pounds and producing more than 150,000 pounds of tractive effort, the 2-8-8-2 Mallet was up to any task put before it.

Thirty new Y6b engines built at the Roanoke shops between 1948 and 1950 were the last compound articulated steam locomotives built in North America. The reliable and powerful modern Class Y6 engines were the final steam engines retired in 1960 when the N&W completed its transition to diesel power.



Norfolk & Western - 2-8-8-2 Y6b Steam Engine
30-1438-1 Proto-Sound® 2.0 \$699.95

Features

- Die-Cast Boiler and Tender Body
- Die-Cast Metal Chassis
- Authentic Paint Scheme
- Metal Wheels and Axles
- Real Coal Load
- Constant Voltage Headlight
- Die-Cast Truck Sides
- Locomotive Speed Control
- (2) Precision Flywheel Equipped Motors
- Engineer and Fireman Figures
- Operating Firebox Glow
- Metal Handrails and Decorative Bell
- Decorative Metal Whistle
- Synchronized Puffing ProtoSmoke™ System
- Remote Controlled Proto-Coupler™
- Operating Tender Back-up Light
- Proto-Sound® 2.0 With The Digital Command System Featuring Freight Yard Proto-Effects™
- Unit Measures: 24 3/4" x 2 1/2" x 3 5/8"
- Operates On O-31 Curves

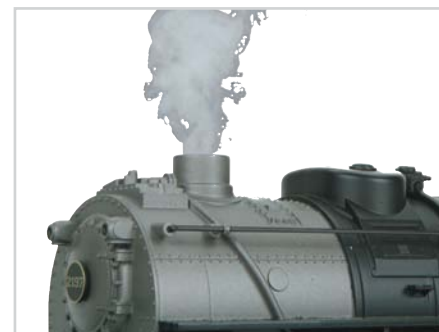
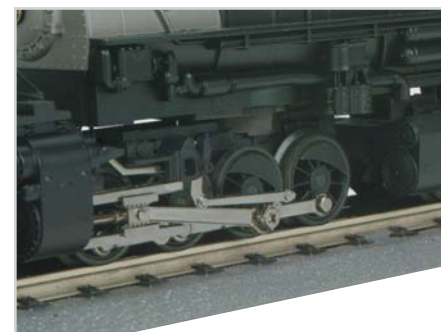

4-6-2 Forty Niner Steam Engine

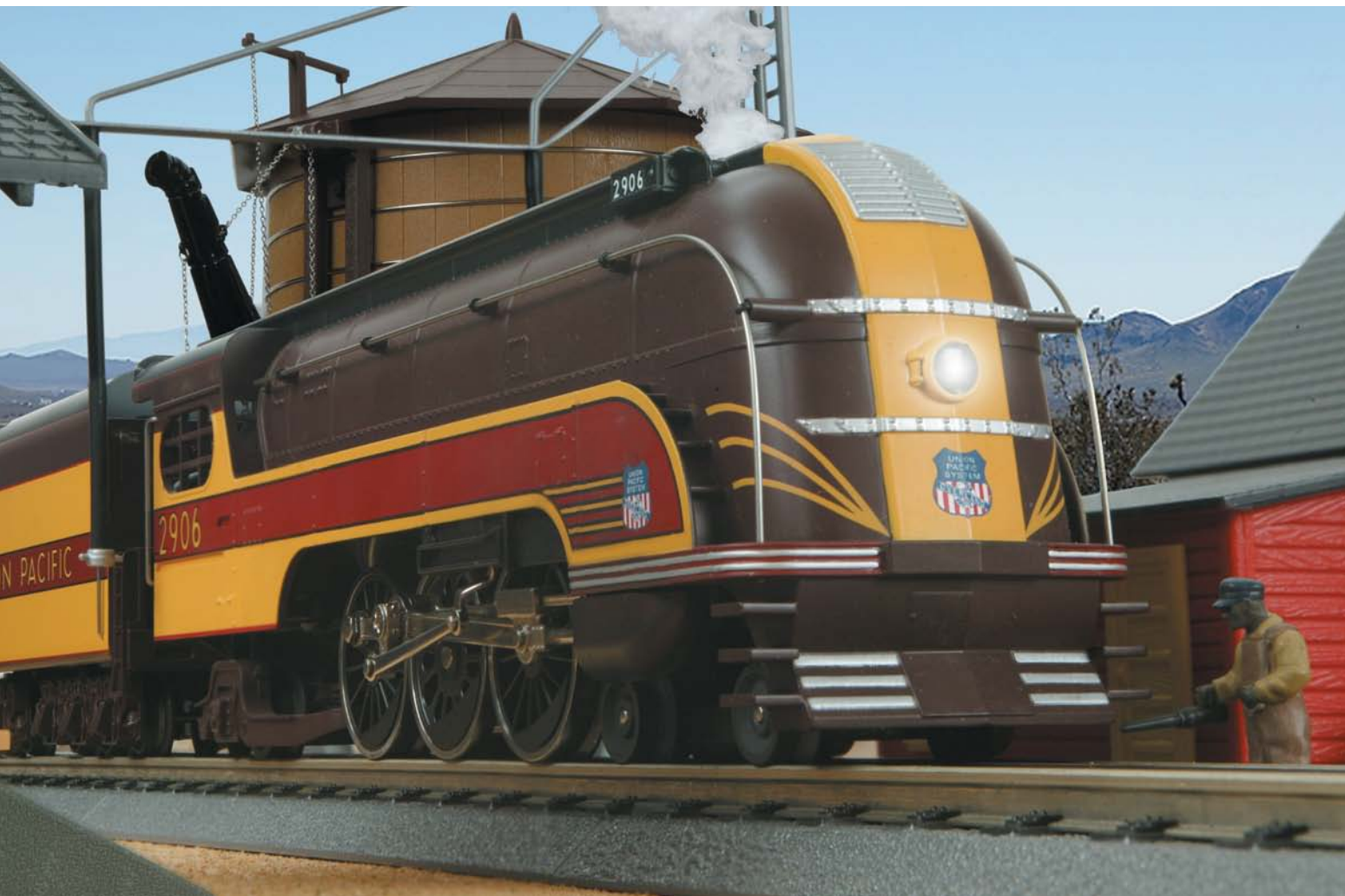

The discovery of gold in California precipitated the Gold Rush of 1849 and forever changed the West. In just over a decade, California was transformed from a sleepy paradise of 14,000 souls to a state with over 300,000 inhabitants. Nearly a century later, the Golden State still had the aura of the Promised Land, and three railroads teamed up in 1937 to inaugurate a train named after the event that started it all. Hauled between Chicago and San Francisco by the Chicago & North Western, Union Pacific, and Southern Pacific Railroads, the Forty Niner was a way to arrive at the Coast in style. Operating on a 49-hour schedule, the train featured its own dedicated air conditioned, streamlined, all-Pullman trainset, with valet and stewardess services as well as a shower and a barber shop.

For its portion of the Forty Niner's journey, the Union Pacific assigned a 4-8-2 Mountain-type steamer to the Cheyenne-Ogden stretch, and Pacific #2906, a 1920 Baldwin product, to the Omaha-Cheyenne run. Both engines were rebuilt with Timken roller bearing light-weight rods and streamlined shrouds, the only steam engines ever to be streamlined by the UP. Inaugurating service in the same year as the Southern Pacific's Daylight, the Forty Niner ran five round trips a month. The most difficult part of the journey proved to be the departure from Omaha's Union Station. The tracks had a definite sag in the middle, and #2906 often had a hard time starting her eight-car train out of this dip, occasionally needing help from the terminal switcher.

Business boomed in 1939 and 1940 as Midwesterners came to the Golden Gate International Exposition on Treasure Island in San Francisco Bay, but in 1941 the Forty Niner was discontinued. Pacific 2906 was assigned to more mundane duties and could often be found with a train of heavyweights in tow.

Add this colorful, kitschy 1930's streamliner to your roster in her original UP colors or one of several "might-have-been" paint schemes. With any version, you'll get Proto-Sound® 2.0's variety of sounds, synchronized puffing smoke, and smooth, steady performance at any speed.



Southern Pacific - 4-6-2 Forty Niner Steam Engine
30-1441-1 Proto-Sound® 2.0 \$399.95



Norfolk & Western - 4-6-2 Forty Niner Steam Engine
30-1440-1 Proto-Sound® 2.0 \$399.95

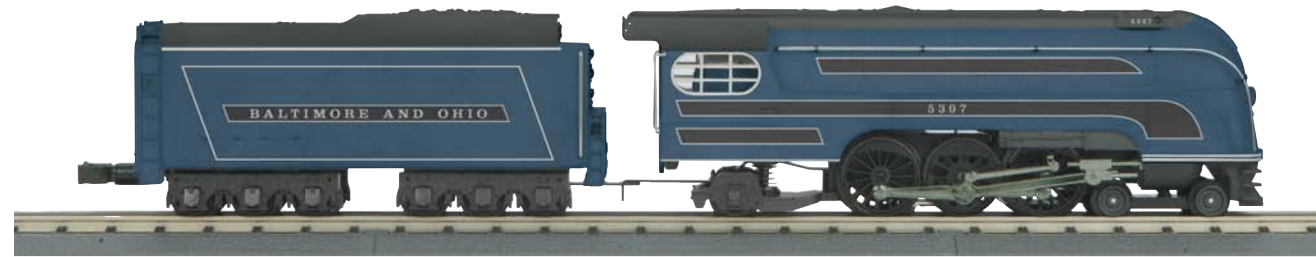

Baltimore & Ohio - 4-6-2 Forty Niner Steam Engine
30-1439-1 Proto-Sound® 2.0 \$399.95



Union Pacific - 4-6-2 Forty Niner Steam Engine
30-1442-1 Proto-Sound® 2.0 \$399.95

Features

- Die-Cast Metal Chassis
- Metal Wheels and Axles
- Precision Flywheel Equipped Motor
- Metal Handrails
- Die-Cast Boiler and Tender Body
- Constant Voltage Headlight
- Die-Cast Truck Sides
- Colorful Paint Scheme
- Remote Controlled Proto-Coupler™
- Synchronized Puffing ProtoSmoke™ System
- Locomotive Speed Control
- Proto-Sound® 2.0 With The Digital Command System Featuring Passenger Station Proto-Effects™
- Unit Measures: 20 1/4" x 2 1/2" x 3 3/4"
- Operates On O-31 Curves

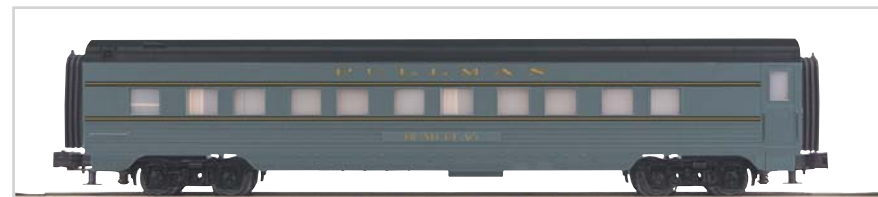

ADD AUTHENTIC MATCHING PASSENGER CARS!

See Page 70

4-6-4 Royal Hudson Steam Engine



Among the most famous of all the Hudsons, Canadian Pacific's Royal Hudsons also had the distinction of sporting the British royal arms and a crown. After King George VI and his entourage toured the country in a royal train powered by a Hudson, CPR added the crown to all 45 of the Hudsons built between 1937 and 1945. Of course, it was not only the royal visit that distinguished the Royal Hudsons. They worked so efficiently that they reduced the number of engine changes needed to cross Canada from fourteen to nine. And for a time, the "Royal York" train between Toronto and Montreal, headed by a Hudson, held the world record for the fastest scheduled train, covering 124 miles in 108 minutes. The last of Canadian Pacific's Royal Hudsons was not retired from regular service until 1960, and a few survivors, including No. 2860, are still popular for tourist excursions.



Canadian Pacific - 4-6-4 Royal Hudson Steam Engine
30-1444-1 Proto-Sound® 2.0 \$429.95

Features

- Die-Cast Metal Chassis
- Metal Wheels and Axles
- Die-Cast Truck Sides
- Precision Flywheel Equipped Motor
- Remote Controlled Proto-Coupler™
- Colorful Paint Scheme
- Metal Handrails and Decorative Bell
- Die-Cast Boiler and Tender Body
- Constant Voltage Headlight
- Locomotive Speed Control
- Synchronized Puffing ProtoSmoke™ System
- Real Coal Load
- Proto-Sound® 2.0 With The Digital Command System Featuring Passenger Station Proto-Effects™
- Unit Measures: 20" x 2 1/2" x 3 1/2"
- Operates On O-31 Curves



Canadian Pacific - 4-Car 60' Streamlined ABS Passenger Set
30-67340 \$199.95

You asked for it! Since the Coors Light Silver Bullet Train debuted in a 2004 TV ad, this imaginary train has been one of our most-requested items. For 2007, we've chosen this silver flyer to introduce a feature that has been latent in Proto-Sound® 2.0 but never used before: the ability of a locomotive to "talk to" its trailing cars or trackside accessories. At your command, The Silver Bullet® steam engine pulls into a station, playing arrival and departure sounds inspired by the television commercials and commanding its three-reefer consist to open its doors, billowing frosty smoke and revealing its chilled contents. Of course the chrome-plated Silver Bullet includes all the features found in every Proto-Sound® 2.0 steamer, including a suite of sound effects, synchronized puffing smoke, and smooth cruise control operation at any throttle setting from a crawl to a speeding Bullet.

Soon after its introduction in 1978, Coors nicknamed its light beer The Silver Bullet because of its sleek aluminum silver can. The Silver Bullet Train delivering ice-cold refreshment from the Rocky Mountains is the brainchild of FCB-Chicago, a division of famed advertising agency Foote Cone & Belding. Although this is Coors' first use of a train as a corporate symbol, the firm has long been a major shipper and receiver of products by rail. Today its Golden, Colorado brewery operates diesel switchers emblazoned with the Coors logo and sends out approximately 300 rail cars of beer every week.

Add a touch of pure fantasy and a great deal of fun to your layout with The Silver Bullet Train and its frosty load. Activate its unique features with virtually any conventional transformer with bell and whistle buttons, or use the M.T.H. DCS™ system for an even more exciting operating experience.

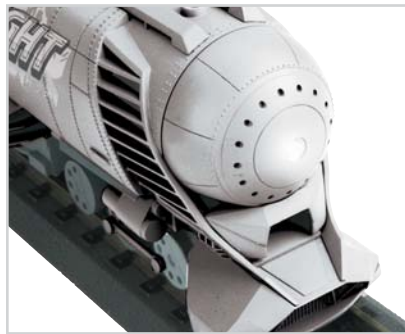

Load Slides Out For Smoke Fill Up

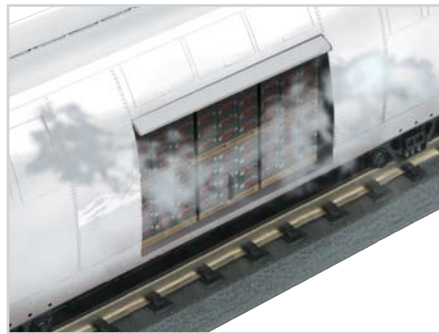

Features

Set Features

- Silver Bullet Locomotive
- (3) Silver Bullet Operating Reefer Cars

Locomotive Features

- Durable ABS Body and Die-Cast Metal Chassis
- Flywheel Equipped Motor
- Locomotive Speed Control
- Electronic Reverse Unit
- Remotely Controlled Proto-Coupler™
- Synchronized Puffing Proto-Smoke™
- Operating Headlight
- All-Metal Wheels and Gears
- Chrome Plated Finish
- Proto-Sound® 2.0 Sound System
- Featuring Freight Station Proto-Effects™
- Measures: 13 1/2" x 2 3/8" x 4 1/4"
- Operates On O-31 Curves

Reefer Cars Feature

- Intricately Detailed Durable ABS Bodies
- Die-Cast 4-Wheel Trucks
- Operating Die-Cast Metal Couplers
- Chrome Plated Finish
- Detailed Loads
- Operating Reefer Doors
- Billowing Simulated Refrigerated Frost
- Fast-Angle Wheel Sets
- Needle-Point Axles
- Metal Wheels and Axles
- Remotely Operated from Transformer, DCS or Operating Track Section
- Reefers Measure: 11 1/2" x 2 1/2" x 4 1/4"



HUGE ROTATING WHEEL



NEW TOOLING! Coors Light - Silver Bullet Train Set
30-1433-1 Proto-Sound® 2.0 \$499.95

Coors Light - Silver Bullet Operating Reefer Car
30-78040 \$79.95

SW-1 Diesel Engine



Features

- Intricately Detailed ABS Body
 - Colorful Paint Scheme
 - Die-Cast Metal Chassis
 - Directionally Controlled Headlight
 - Metal Wheels, Axles and Gears
 - Die-Cast Truck Sides, Pilots and Fuel Tank
 - (2) Remotely Controlled Proto-Couplers™
 - Metal Handrails and Decorative Horn
 - (2) Precision Flywheel Equipped Motors
 - Locomotive Speed Control
- Proto-Sound® 2.0 With The Digital Command System Featuring Freight Yard Proto-Effects™
 - Unit Measures: 12" x 2 3/4" x 4"
 - Operates On O-31 Curves

The birth of the SW1 in January 1939 was a historic moment for the Electro-Motive Corporation. The tiny switcher ("S" for six hundred horsepower, "W" for welded frame) was EMC's first truly mass-produced loco, the first with Electro-Motive's own electrical gear, and the first mass-produced engine powered by the 567 diesel motor - which would become the backbone of first-generation American diesel power. Popular with railroads large and small, the SW1 stayed in production for 15 years, and many remained in service for three or more decades. New for 2007, our RailKing Scale SW1 has everything you'd want in a switcher: front and rear remote Proto-Couplers™, smooth performance at any speed down to 3 scale miles per hour, dual-motor power, and authentic EMD sounds.

NEW TOOLING!



New York Central - SW-1 Diesel Engine
30-2745-1 Proto-Sound® 2.0 \$299.95

NEW TOOLING!



Chessie - SW-1 Diesel Engine
30-2743-1 Proto-Sound® 2.0 \$299.95

NEW TOOLING!



Boston & Maine - SW-1 Diesel Engine
30-2742-1 Proto-Sound® 2.0 \$299.95



Lehigh Valley - SW-1 Diesel Engine
30-2744-1 Proto-Sound® 2.0 \$299.95

NEW TOOLING!



Pennsylvania - SW-1 Diesel Engine
30-2746-1 Proto-Sound® 2.0 \$299.95

NEW TOOLING!

SW-1500 Diesel Engine



EMD, famous for its successful production of quality locomotives, hit the target once again when the company introduced the SW1500 and its cousin the SW1000 on January 1, 1966. These locomotives were the latest in the SW line of switchers that had been tremendously popular since the mid-1930s. Under their hoods throbbled EMD's newly-released 645E prime mover. The SW1500 sported a 12-cylinder version that developed 1500 hp, and the SW1000 featured a smaller 1000 hp, 8-cylinder version. Externally the two switchers were quite similar; a second exhaust stack and a larger radiator in the top front of the hood distinguished the SW1500, which proved to be the more popular of the two.

The list of optional equipment for the SW1500 - which included a larger fuel tank, smoother-riding trucks, and ballasting to add weight - suggests that EMD expected the locomotive to be used as a true road switcher. Many railroads did just that.

The RailKing SW1500 is sure to be an eye-catching addition to your own model railroad. Put it to work in the yard, or let it show its worth on the main line. M.T.H. is offering this handy loco in a variety of roadnames for fun and versatility, and each is equipped with the power and performance of Proto-Sound® 2.0.

Did You Know?

Compared with earlier EMD switchers, the SW1000 and SW1500 had a taller cab profile. While this aided visibility for the crew, it caused clearance problems for some industrial customers. To accommodate those users, EMD produced the SW1001 with a smaller cab to accommodate tight conditions in industrial switching areas.



Union Pacific - SW1500 Switcher Diesel Engine
30-2750-1 Proto-Sound® 2.0 \$299.95



Pittsburgh Industrial Railroad - SW1500 Switcher Diesel Engine
30-2749-1 Proto-Sound® 2.0 \$299.95



New York & Atlantic - SW1500 Switcher Diesel Engine
30-2747-1 Proto-Sound® 2.0 \$299.95

Features

- Intricately Detailed ABS Body
- Colorful Paint Scheme
- Die-Cast Metal Chassis
- Die-Cast Truck Sides, Pilots and Fuel Tank
- Metal Wheels, Axles and Gears
- Metal Handrails and Decorative Horn
- (2) Precision Flywheel Equipped Motors
- Directionally Controlled Headlights
- (2) Remotely Controlled Proto-Couplers™
- Locomotive Speed Control
- Proto-Sound® 2.0 With The Digital Command System Featuring Freight Yard Proto-Effects™
- Unit Measures: 11 3/4" x 2 1/2" x 4"
- Operates On O-31 Curves

Norfolk Southern - SW1500 Switcher Diesel Engine

30-2748-1 Proto-Sound® 2.0 \$299.95



VO 1000 Diesel Engine



Pennsylvania - VO 1000 Diesel Engine
30-2753-1 Proto-Sound® 2.0 \$299.95

The Baldwin Locomotive Works had been building steam engines for a century before it sold its first production diesel in 1937. While most of Baldwin's diesels were ultimately disappointments to its customers, the engines' unique looks won the hearts of American railfans and modelers. Nothing else on rails looked like the baby-faced 24-wheeled Centipedes or the Raymond Loewy-styled Sharknoses. The distinctive VO 1000, perhaps the most muscular looking of all first-generation diesel switchers, was Baldwin's most successful product. The U.S. military and over 30 class one railroads bought 548 copies of the 1000 hp. engine between 1939 and 1946.

All Baldwin diesels were powered by variations of the same De La Vergne diesel motor. Acquired by Baldwin in 1931, the De La Vergne Engine Company had started life in 1880 making mechanical refrigeration machines for breweries. Its power plant for Baldwin's locomotives was rather unique among diesels of its time. In order to make the fuel burn slower and give their 4-cycle engine a longer power stroke, De La Vergne's designers used massive cylinders more than a foot in diameter and added a separate combustion chamber above each cylinder. To allow the fuel more time to burn, they ran the engine at a maximum speed of 625 rpm — just over half the speed of most competitive diesels. In the October 1936 issue of Baldwin Locomotives Magazine, the company claimed that "slow combustion gives low fuel consumption, absence of smoke, quick pick-up, and smooth idling."

Ultimately the massive De La Vergne motor proved to be both a blessing and a curse. Teamed up with equally heavy-duty traction motors supplied by Westinghouse, Baldwin's prime mover found its niche in low-speed lugging assignments, which it handled relatively well. But those were just the types of assignments in which crews tended to abuse equipment and push an engine to its limits. As a result, Baldwin engines eventually developed a reputation for high maintenance costs. The VO 1000 switcher, with its normally aspirated 8-cylinder engine, was actually one of Baldwin's most dependable locomotives, and many served for decades. The turbocharged models that succeeded the VO 1000, however, were plagued with problems that included excessive piston wear. By 1956 it was clear that Baldwin was no longer a contender in the diesel business, and the nation's oldest locomotive builder threw in the towel.

Relive the excitement and variety of the early diesel years with the RailKing Scale VO 1000. Thanks to ProtoSound® 2.0, our model features authentic Baldwin prime mover sounds and the ability to duplicate the low-speed lugging power of its prototype — as well as the ability to hustle along virtually as fast as you care to run it.



Union Pacific - VO 1000 Diesel Engine
30-2754-1 Proto-Sound® 2.0 \$299.95



Atlantic Coast Line - VO 1000 Diesel Engine
30-2751-1 Proto-Sound® 2.0 \$299.95



Great Northern - VO 1000 Diesel Engine
30-2752-1 Proto-Sound® 2.0 \$299.95

Features

- Intricately Detailed ABS Body
- Colorful Paint Scheme
- Die-Cast Metal Chassis
- Die-Cast Truck Sides, Pilots and Fuel Tank
- Directionally Controlled Headlights
- Metal Wheels, Axles and Gears
- (2) Remotely Controlled Proto-Couplers™
- (2) Precision Flywheel Equipped Motors
- Locomotive Speed Control
- (2) Cab Figures
- Proto-Sound® 2.0 With The Digital Command System Featuring Freight Yard Proto-Effects™
- Unit Measures: 14 1/2" x 2 1/2" x 3 1/2"
- Operates On O-31 Curves

Alco Rs-1 Diesel Engine



The American Locomotive Company pioneered the multi-purpose "road switcher" design in 1941 with its 1000 hp RS-1. Alco's designers added a second, shorter hood to a basic switcher to make room for a steam boiler for passenger train heat. The short hood also afforded the crew additional accident protection. Smoother-riding trucks made the RS-1 suitable for the higher road speeds that would be daunting in a typical switcher. Although EMD's later GP7 and GP9 sold better and really established the road switcher as a universal locomotive, the RS-1 had the longest production run of any American-made diesel. The last new RS-1 left Alco's shops in 1960.

Interestingly, the first two years of RS-1 production went to the military. The 13 units that had been delivered to American railroads were requisitioned from their owners, and, along with 144 additional engines, were sent to Iran, Russia, and U.S. Army posts. These RS-1s were fitted with three-axle trucks to make them suitable for lighter rail on overseas roads. A group that plied the Trans-Iranian Railroad became known as "the diesels that saved Russia" because they brought in food and other supplies after the Luftwaffe had crippled Russian shipping. These engines later became the prototype for Russia's own early diesels.

The RS-1 debuts in the M.T.H. RailKing Line in 2005, fully outfitted with the power and performance of Proto-Sound® 2.0. Built to 1/48 scale proportions like the RailKing Scale RS-3, the RailKing RS-1 beautifully portrays the first road switcher in American railroading. At home with either freight or passenger consists, the RS-1 is appropriate for a model railroad set in any period from the 1940s through the 1980s.



Santa Fe - Alco Rs-1 Diesel Engine
 30-2737-1 Proto-Sound® 2.0 \$299.95
 30-2737-3 Non-Powered \$129.95



Alaska - Alco Rs-1 Diesel Engine
 30-2734-1 Proto-Sound® 2.0 \$299.95
 30-2734-3 Non-Powered \$129.95



Chicago NorthWestern - Alco Rs-1 Diesel Engine
 30-2735-1 Proto-Sound® 2.0 \$299.95
 30-2735-3 Non-Powered \$129.95



Milwaukee Road - Alco Rs-1 Diesel Engine
 30-2736-1 Proto-Sound® 2.0 \$299.95
 30-2736-3 Non-Powered \$129.95

Features

- Intricately Detailed ABS Body
- Colorful Paint Scheme
- Die-Cast Metal Chassis
- Metal Handrails and Decorative Horn
- Die-Cast Truck Sides, Pilots and Fuel Tank
- (2) Cab Figures
- Directionally Controlled Headlights
- Metal Wheels, Axles and Gears
- (2) Remotely Controlled Proto-Couplers™
- (2) Precision Flywheel Equipped Motors
- Locomotive Speed Control
- Proto-Sound® 2.0 With The Digital Command System Featuring Freight Yard Proto-Effects™
- Unit Measures: 14" x 2 1/2" x 4"
- Operates On O-31 Curves

Alco PA Diesel Engine



The PA was Alco's glamour girl. While Electro-Motive's E-units easily beat Alco's passenger engine in terms of popularity, the PA is widely regarded as the most beautiful first-generation diesel - period. Perhaps no other locomotive looked so right at the head of the streamlined trains of the late forties and fifties that were the last hurrah of American long-distance passenger service. The 294 PA's and cabled PB's built between 1946 and 1953 powered some of the most famous name trains from coast to coast, from the Santa Fe's Super Chief to the New Haven's Merchants' Limited.

The muscular PA profile and its elegant nose with the characteristic grille around the headlight were designed by Ray Patten of General Electric. At the time, GE and Alco were partners in the locomotive business, with GE making the electrical equipment for all Alco diesels. While Alco would later fall by the wayside, GE went on to become America's largest locomotive builder by the early 1990's. Under the hood of the PA beat a 16-cylinder model 244 prime mover that developed 2000 hp. Depending on their gearing, PA's could hustle a passenger consist along at up to 100 mph.

Long after all other PA's had gone to scrap, four restored ex-Santa Fe units remained in service on the Delaware & Hudson into the late 1970's. Sold to the Ferrocarriles Nacionales de Mexico (FNM) in 1978, most of the units eventually deteriorated to junk status, although one remained operational. But in April of 2000, Doyle McCormack - who also happens to be the engineer of 4449, the restored Southern Pacific Daylight - and the Smithsonian Institution repatriated two of the junked units for rebuilding. One of the units will be restored to Santa Fe livery for static display, while Doyle is bringing the other PA back to life in the Nickel Plate Road "Bluebird" scheme. You can follow the progress of Doyle's labor on the Web site www.nkp190.com.



New York Central - Alco PA AA Diesel Set

30-2730-1	Proto-Sound® 2.0	\$299.95
30-2730-3	B-Unit	\$99.95



Did You Know?

In the classification PA-1, the P stands for passenger, the A for the cab unit, and the 1 for the first model made. Later units were models PA-2 and PA-3.



Pennsylvania - Alco PA AA Diesel Set

30-2731-1	Proto-Sound® 2.0	\$299.95
30-2731-3	B-Unit	\$99.95



Southern - Alco PA AA Diesel Set

30-2732-1	Proto-Sound® 2.0	\$299.95
30-2732-3	B-Unit	\$99.95



Union Pacific - Alco PA AA Diesel Set

30-2733-1	Proto-Sound® 2.0	\$299.95
30-2733-3	B-Unit	\$99.95

Features

- Colorful Paint Scheme
- Metal Chassis
- Die-Cast Truck Sides, Pilots and Fuel Tank
- (2) Remotely Controlled Proto-Couplers™
- (2) Precision Flywheel Equipped Motors
- Metal Wheels, Axles and Gears
- Directionally Controlled Headlights
- Intricately Detailed ABS Bodies
- Locomotive Speed Control
- Proto-Sound® 2.0 With The Digital Command System Featuring Passenger Station Proto-Effects™
- Unit Measures: 28 1/2" x 2 1/2" x 3 5/8"
- Operates On O-31 Curves



ADD A MATCHING PASSENGER SET

See Pages 70-73

GP-9 Diesel Engine



Western Maryland - GP-9 Diesel Engine
 30-2741-1 Proto-Sound® 2.0 \$299.95
 30-2741-3 Non-Powered \$129.95

Electro-Motive Division's GP (for "General Purpose") engines were the brainchild of project engineer Dick Dilworth. In the late 1940s, Dilworth saw that America's 30,000 miles of main line rail had been virtually dieselized, but the 130,000 miles of secondary lines that carried half of the nation's freight traffic were still largely steam powered. He viewed that as a huge marketing opportunity.

In *The Dilworth Story*, a book published by Electro-Motive Division in 1954, Dilworth explained how he tried to meet that opportunity: "In planning the GP, I had two dreams. The first was to make a locomotive so ugly in appearance that no railroad would want it on the main line or anywhere near headquarters, but would keep it out as far as possible in the back country, where it could do really useful work. My second dream was to make it so simple in construction and so devoid of Christmas-tree ornaments and other whimsy that the price would be materially below our standard main-line freight locomotives."

Of course, Dilworth's explanation conveniently ignored the fact that Alco's arguably uglier RS-1 had introduced the road switcher concept eight years before EMD. And in one sense, Dilworth's project was a failure. Railroads bought Geeps for mainline service and relegated older power to secondary lines as they had always done. But his brainchild became the runaway best-seller among first-generation diesel power. U.S. and Canadian railroads bought nearly 7,000 copies of the 1500 horsepower GP7, introduced in 1949, and the 1750 horsepower GP9, produced from 1954 through 1963.

Except for the placement of a few ventilator louvers, the exterior of the GP9 was virtually identical to that of its older brother. Contrary to model railroading urban legend, the presence or absence of the dynamic brake blister on the top center of the long hood does not distinguish between the two locomotives, as both were available with optional dynamic braking.

Adding a full-featured, scale-proportioned locomotive to your diesel roster has never been easier than with the RailKing Scale GP9. Fully equipped with Proto-Sound® 2.0, RailKing Scale engines may be the best value in all of model railroading. Watching these engines creep down the rails with the industry's best speed control system and hearing the incredible variety of sounds may just make the GP9 your favorite diesel. It's all possible thanks to the power and performance of Proto-Sound® 2.0.



Pittsburgh & Lake Erie - GP-9 Diesel Engine
 30-2740-1 Proto-Sound® 2.0 \$299.95
 30-2740-3 Non-Powered \$129.95



Grand Trunk Western - GP-9 Diesel Engine
 30-2738-1 Proto-Sound® 2.0 \$299.95
 30-2738-3 Non-Powered \$129.95



Maryland & Pennsylvania - GP-9 Diesel Engine
 30-2739-1 Proto-Sound® 2.0 \$299.95
 30-2739-3 Non-Powered \$129.95

Features

- Directionally Controlled Headlights
- Intricately Detailed ABS Body
- Die-Cast Truck Sides, Pilots and Fuel Tank
- (2) Remotely Controlled Proto-Couplers™
- Authentic Paint Scheme
- Metal Handrails and Decorative Horn
- (2) Precision Flywheel Equipped Motors
- Metal Wheels, Axles and Gears
- (2) Cab Figures
- Locomotive Speed Control
- Operating Smoke Unit
- Proto-Sound® 2.0 With The Digital Command System Featuring Freight Yard Proto-Effects™
- Unit Measures: 14 3/4" x 2 1/2" x 3 3/4"
- Operates On O-31 Curves

F3 ABA Set



When the prototype railroads began to dieselize in the 1940s, model train manufacturers soon followed recognizing that boys wanted models of the newest trains they were seeing on real railroads. One of the initial toy train forays into dieselism was a replica of the best-selling diesel of the day, the F3 "covered wagon" made by the Electro Motive Division of General Motors.

Recognizing that EMD and the railroads were anxious to publicize their modern motive power, General Motors, the Santa Fe Railroad, and the New York Central Railroad helped share the cost of dies for the original models in exchange for having their names on engines that appeared on virtually every boy's holiday wish list for

years. In the end, it seems the Santa Fe got the best deal, as its red, yellow, and silver "warbonnet" F3s remained a popular fixture on model railroad locomotives longer than any other railroad livery.

To this day, the F3 diesels of the late 1940s and early 1950s are recognized as some of the best toys ever produced. Virtually full O gauge scale models, they were tremendously dependable, highly detailed for their time, and terrific pullers.

Postwar and RailKing Scale fans will no doubt want to order this stellar M.T.H. replica of model railroading's most famous diesel. The look and feel of the classic original is

faithfully reproduced, right down to the die-cast metal chassis. Under the hood, however, lies the power and performance of ProtoSound® 2.0, twin flywheel-equipped motors, and Proto-Smoke, offering today's model railroaders an operating experience that boys of the 1950s could only dream about.

Did You Know?

In a December 1950 radio show, famed comedian Jack Benny wrote a letter to Dear Santa Fe, saying "Christmas is almost here and it would make me happy if you gave me a train." While the railroad did not give Benny the real train he asked for, its publicity department did send him a toy train model of the F3.

Features

Set Features

- F-3 ABA Diesel Set
- 4-Car Streamlined Passenger Set

Locomotive Features

- Colorful Paint Scheme
- Die-Cast Metal Chassis
- Die-Cast Truck Sides, Pilots and Fuel Tank
- Metal Wheels, Axles and Gears
- (2) Precision Flywheel Equipped

Motors In Powered A Unit

- (2) Remotely Controlled Proto-Couplers™ (one per A Unit)
- Directionally Controlled Headlights
- Intricately Detailed ABS Bodies
- Locomotive Speed Control
- Engineer Cab Figure In Each A Unit
- Operating Smoke Unit In Powered A Unit
- ABA Set Measures: 40 1/4" x 2 5/8" x 3 3/4"

Passenger Car Features

- Durable ABS Intricately Detailed Bodies
- Metal Wheels and Axles
- Overhead Interior Lighting
- Die-Cast 4-Wheel Trucks
- Operating Die-Cast Metal Couplers
- Colorful, Attractive Paint Schemes
- End-of-Car Diaphragms
- Fast-Angle Wheel Sets

- Needle-Point Axles
- Detailed Car Interiors
- 4-Car Sets Feature:
 - (1) Baggage,
 - (1) Coach, (1) Vista Dome,
 - (1) Observation
- 4-Car Set Measures: 68 3/4" x 2 5/8" x 3 5/16"



Texas Special - F-3 ABA Diesel Passenger Set

30-2761-1 Proto-Sound® 2.0 \$649.95



Santa Fe Yellow Bonnet - F-3 ABA Diesel Passenger Set

30-2762-1 Proto-Sound® 2.0 \$649.95

GG-1 Electric Engine



For more than two decades, the Pennsylvania Railroad experimented with locomotive designs in search of a passenger electric for high-speed mainline service. That search ended in 1934 with the GG1, a cooperative effort by the PRR, Baldwin, Westinghouse, and General Electric, based largely on neighbor New Haven's successful EP3 juice jack. Industrial designer Raymond Loewy cleaned up the original riveted body to create a design that looked contemporary for half a century.

The GG1 fleet hustled passenger traffic of all types along the Pennsy's multi-track raceway from New York to Washington and west to Harrisburg, including the famed Congressional and Broadway Limited. With 18 Pullmans in tow, a GG1 could hit 100 mph. Regearred for freight service and run as double-headers, a pair of GG1s could provide about the same tractive effort as a Union Pacific Big Boy, with virtually no noise, no smoke, much less wear on the track, and significantly less maintenance. Many GG1s racked up more than five million miles of service, outlasting the railroad that built them and serving its two successors, the Penn Central and Conrail. If there were a Locomotive Hall of Fame, the Pennsylvania Railroad GG1 would surely be one of the first inductees.

Add this fully die-cast Hall of Famer to your layout as a complete set or in one or more authentic PRR liveries, featuring station sounds for Pennsy name trains, smooth performance at any speed from a crawl to full throttle, and dual-motored power to rival the prototype.



Pennsylvania (Tuscan Single Stripe) GG-1 Electric Engine
30-2590-1 Proto-Sound® 2.0 \$399.95



Pennsylvania (Green Single Stripe) GG-1 Electric Engine
30-2587-1 Proto-Sound® 2.0 \$399.95



Pennsylvania (Silver)- GG-1 Electric Engine
30-2588-1 Proto-Sound® 2.0 \$399.95



Pennsylvania - GG-1 Passenger Train Set
30-2591-1 Proto-Sound® 2.0 \$499.95



Pennsylvania - GG-1 Express Beer Train Set
30-2592-1 Proto-Sound® 2.0 \$499.95

Features

- Colorful Paint Scheme
- Metal Chassis
- Metal Wheels, Axles and Gears
- (2) Precision Flywheel Equipped Motors
- Intricately Detailed Die-Cast Body
- Die-Cast Truck Sides & Pilots
- Directionally Controlled Headlights
- (2) Remotely Controlled Proto-Couplers™
- Metal Handrails and Decorative Horn
- Locomotive Speed Control
- Proto-Sound® 2.0 With The Digital Command System Featuring Passenger Station or Freight Yard Proto-Effects™
- Unit Measures: 15" x 2 5/8" x 4"
- Operates On O-31 Curves

LO-V 4-Car Subway Set



As the IRT (Interborough Rapid Transit) subway expanded in New York City, the need for additional equipment prompted the ordering of 600 low voltage type motor cars. One hundred of these cars came from Pullman in 1916 and 1917, while the remaining 100 were purchased from American Car and Foundry in 1924. An additional 510 non-powered trailer cars entered service between 1916 and 1922. Typical of subway equipment of their day, the steel-sided cars featured rattan seating and rather dim overhead lighting.

The LO-V cars, as the low voltage equipment came to be known, used a low voltage controller, or throttle, to control the high voltage that actually powered the car. This marked a dramatic improvement in safety for the motorman, who in previous HI-V cars had his hand on a controller directly connected to 600 volts of direct current on the third rail. The LO-V cars incorporated a master controller powered by a 32-volt battery, enabling the motorman to control the 600 volts passing through the DC group switches located under the car without fear of electrocution. The LO-V cars served for nearly four decades before being replaced by new cars with plush seating and bright fluorescent lighting.

The RailKing LO-V subway set features transit stop simulation available only from M.T.H. Designed specifically for our municipal transit cars, the unique Proto-Sound® 2.0 transit program features Station Stop Proto-Effects™, allowing you to program the train to stop automatically at designated station stops, even in Conventional Mode. When configured to run on automatic, the LO-V subway stops itself at locations you define and calls out station names that you select in advance; the subway essentially runs itself. And when you program the LO-V for an out-and-back route, it even reverses itself and heads back downtown when it reaches the end of the line - stopping along the way at each station to broadcast the name of the stop and the hustle and bustle of passengers coming and going.



Metropolitan Two-Tone Green LO-V 4-Car Subway Set
30-2756-1 Proto-Sound® 2.0 \$399.95



Metropolitan Two-Tone Green LO-V 2-Car Subway Add-on Set
30-2756-3 Non-Powered \$149.95



Metropolitan LO-V 4-Car Subway Set
30-2757-1 Proto-Sound® 2.0 \$399.95



Metropolitan LO-V 2-Car Subway Add-on Set
30-2757-3 Non-Powered \$149.95



Metropolitan Work Train LO-V 2-Car Subway Add-on Set
30-2758-3 Non-Powered \$149.95



Metropolitan Work Train LO-V 4-Car Subway Set
30-2758-1 Proto-Sound® 2.0 \$399.95

Features

- Directionally Controlled Headlights
- Intricately Detailed ABS Bodies
- Metal Wheels and Axles
- (2) Remotely Controlled Proto-Couplers™
- Authentic Paint Scheme
- Operates On O-31 Track
- Locomotive Speed Control
- All Metal Wheels and Gears
- (2) Precision Flywheel Equipped Motors In Powered Unit
- Metal Chassis
- Die-Cast Truck Sides
- Lighted Interior
- Proto-Sound® 2.0 With The Digital Command System Featuring: Station Stop Proto-Effects™
- Each Car Measures: 14 5/8" x 2 1/4" x 3 1/8"

SCALE SIZED!

6000 Series 4-Car Subway Set



In the mid-1940s, Chicago's public transit system was in a dismal state, with much of its equipment dating back to the turn of the century. In April 1945, the Chicago Transit Authority was created as a government agency to take over and run all the privately owned elevated ("L") and streetcar operations. One of the CTA's first acts was to order 130 new 6000-series cars to replace older equipment. Eventually the 6000-series grew to 720 cars delivered from 1950-1959, the largest series of cars ever built for the CTA® and, for many, the classic symbol of Chicago's "L."

The 6000's were the first large series of "L" cars with a feature borrowed from the North Shore's Electroliners (shown elsewhere in this catalog): curved sides that were narrow at the floor to accommodate "L" platforms and wider at the window line to give passengers more room. The 6000's also borrowed much of their electrical technology from the PCC streetcar design of the late 1930s. And beginning with car 6201, they borrowed a whole lot more. The CTA had realized that its fleet of nearly-new PCC cars had been made superfluous by the automobile and new bus routes. So, beginning in 1953, it sent 520 "Green Hornet" streetcars to the St. Louis Car Co., where their trucks, motors, electrical equipment, window frames, and other parts were recycled into new 6000-series cars.

For 2007, this quintessential Chicago "L" car debuts in the RailKing line in its original paint scheme of Mercury green, Swamp Holly orange, and Croydon cream, as well as the red, white, and blue Bicentennial scheme. Like all M.T.H. transit cars, this model features Station Stop Proto-Effects™, allowing you to program the train to stop automatically at designated station stops and announce authentic Chicago station names.

For more information on the 6000-series cars and the entire Chicago "L" system, visit www.Chicago-L.org



NEW TOOLING! Chicago - 4-Car 6000 Series Subway Set
30-2673-1 Proto-Sound® 2.0 \$399.95



NEW TOOLING! Chicago - 2-Car 6000 Series Subway Set Add-On
30-2673-3 Non-Powered \$149.95



NEW TOOLING! Chicago Bicentennial - 2-Car 6000 Series Subway Set Add-On
30-2755-3 Non-Powered \$149.95

Features

- Directionally Controlled Headlights
- Intricately Detailed ABS Bodies
- Metal Wheels, Axles and Gears
- Die-Cast Truck Sides & Pilots
- (2) Remotely Controlled Proto-Couplers™
- Authentic Paint Scheme
- (2) Precision Flywheel Equipped Motors
- Locomotive Speed Control
- Proto-Sound® 2.0 Featuring Station Stop Proto-Effects™
- Lighted Car Interiors
- Illuminated Number Boards
- Each Car Measures 13 1/2" x 2 1/2" x 3 3/8"
- Operates On O-31 Curves

SCALE SIZED!

NEW TOOLING! Chicago Bicentennial - 4-Car 6000 Series Subway Set
30-2755-1 Proto-Sound® 2.0 \$399.95

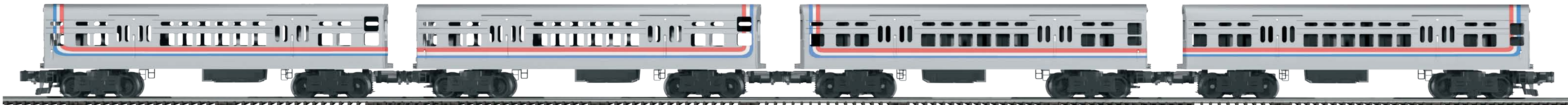

Q-Type El Cars

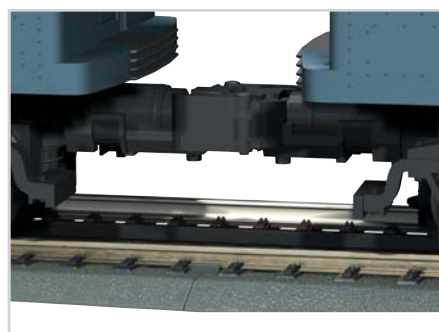

In the late 1930s, the Brooklyn-Manhattan Transit Corporation rebuilt 90 turn-of-the-century wooden elevated cars for service to the 1939-40 World's Fair. Steel ends replaced the original open wood platforms and the BMT shops installed new doors and control systems. The cars were semi-permanently coupled into three-car sets, with two motorized units flanking an unpowered trailer. The Q (for "Queens") cars served on the Flushing Line until 1949 and the following year began a new career on the Third Avenue Elevated. Like the proverbial phoenix, the cars — now more than half a century old — began yet another life in 1957, when they were moved to the Myrtle Avenue Elevated. When the Q-Types were finally

retired in 1969, the oldest cars had been in continuous service for 66 years — the longest career of any New York City transit car. Today you can see a preserved Q-Type in the New York Transit Museum, the only rail museum in America located in a former subway station.

The RailKing Q-Type El cars feature transit stop simulation available only from M.T.H. Designed specifically for our municipal transit cars, the unique Proto-Sound® 2.0 transit program features Station Stop Proto-Effects, allowing you to program the train to stop automatically at designated station stops, even in Conventional Mode. When configured to run on automatic, the Q-Type stops itself at

locations you define and calls out station names that you select in advance; the train essentially runs itself. And when you program the Q-Type for an out-and-back route, it even reverses itself and heads back downtown when it reaches the end of the line — stopping along the way at each station to broadcast the name of the stop and the hustle and bustle of passengers coming and going.

For more information on the Q-Type and the entire New York City transit system, visit www.nycsubway.org



NEW TOOLING! New York Transit (Blue) Q-Type El Car Set
 30-2760-1 Proto-Sound® 2.0 \$349.95
 New York Transit (Blue) Q-Type El Car Add-on Set
 30-2760-3 Non-Powered \$199.95

NEW TOOLING! New York Transit (Green) Q-Type El Car Set
 30-2759-1 Proto-Sound® 2.0 \$349.95
 New York Transit (Green) Q-Type El Car Add-on Set
 30-2759-3 Non-Powered \$199.95

Features

- Directionally Controlled Headlights
- Intricately Detailed ABS Bodies
- Metal Wheels and Axles
- (2) Remotely Controlled Proto-Couplers™
- Authentic Paint Scheme
- Operates On O-31 Track
- Locomotive Speed Control
- All Metal Wheels and Gears
- (2) Precision Flywheel Equipped Motors In Powered Unit
- Metal Chassis
- Die-Cast Truck Sides
- Lighted Interior
- Proto-Sound® 2.0 With The Digital Command System Featuring: Station Stop Proto-Effects™
- Each Car Measures: 14 5/8" x 2 1/4" x 3 1/8"

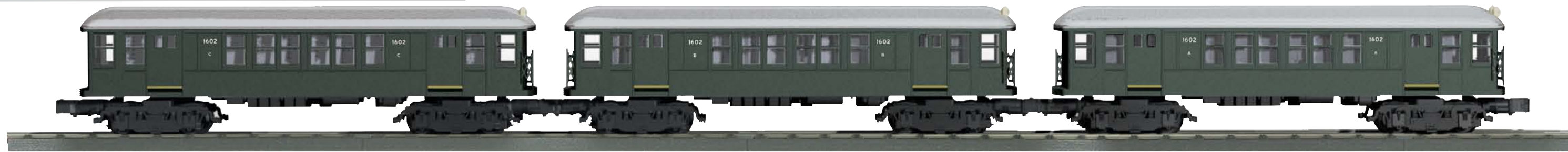

SCALE SIZED!

RAILKING TRANSIT 41



High quality, traditionally sized RailKing Freight Cars provide detailed bodies and colorful paint schemes for the O Gauge railroader. MTH makes an enormous variety of RailKing Freight Cars, including many different car types and road-names. No matter what era or part of the country you are modeling, RailKing is sure to have something for you.

RailKing Freight Car Trucks



**3-Rail Bettendorf
Freight Car Two Truck Pack**
30-89001 \$12.99

**3-Rail Roller Bearing
Freight Car Two Truck Pack**
30-89002 \$12.99



Major League Baseball trademarks and copyrights are used with permission of Major League Baseball Properties, Inc. MLB.com MTH Trains/MLBP 2006



©2006, NFL Enterprises LLC. NFL and the NFL Shield design are registered trademarks of the National Football League. The team names, logos and uniform designs are registered trademarks of the teams indicated.



Grand Trunk Western - Rotary Snow Plow
30-79178 \$59.95



Boston & Maine - Rotary Snow Plow
30-79177 \$59.95



NASA - Flat Car w/Operating Helicopter
30-79176 \$59.95



Alaska - Flat Car w/Operating Helicopter
30-79175 \$59.95

Rotary Snow Plow

Features

- Metal Wheels and Axles
- Die-Cast 4-Wheel Trucks
- Operating Die-Cast Metal Couplers
- Colorful, Attractive Paint Schemes
- Decorative Brake Wheels
- Fast-Angle Wheel Sets
- Needle-Point Axles
- Intricately Detailed Durable ABS Body
- Operating Interior Lighting
- Motorized Spinning Rotary Blade
- Unit Measures: 12" x 2 3/8" x 3 3/4"
- Operates On O-27 Curves

Helicopter

Features

- Metal Wheels and Axles
- Die-Cast 4-Wheel Trucks
- Operating Die-Cast Metal Couplers
- Colorful, Attractive Paint Schemes
- Fast-Angle Wheel Sets
- Needle-Point Axles
- Intricately Detailed Durable ABS Body
- Operating Helicopter
- Motorized Launch Base
- Unit Measures: 11 5/8" x 3 3/8" x 4 1/2"
- Operates On O-27 Curves



50' Double Door Plugged Boxcar



Chessie - 50' Double Door Plugged Boxcar
30-74430 \$44.95



Denver Rio Grande - 50' Double Door Plugged Boxcar
30-74431 \$44.95



Lehigh Valley - 50' Double Door Plugged Boxcar
30-74432 \$44.95



Pennsylvania - 50' Double Door Plugged Boxcar
30-74433 \$44.95

- Features**
- Intricately Detailed Durable ABS Body
 - Metal Wheels and Axles
 - Die-Cast 4-Wheel Trucks
 - Operating Die-Cast Metal Couplers
 - Colorful, Attractive Paint Schemes
 - Decorative Brake Wheels
 - Fast-Angle Wheel Sets
 - Needle-Point Axles
 - Unit Measures: 13" x 2 1/2" x 3 1/2"
 - Operates On O-31 Curves

4-Bay Hopper Car



Chesapeake & Ohio - 4-Bay Hopper Car
30-75233 \$39.95



Chicago NorthWestern - 4-Bay Hopper Car
30-75234 \$39.95



M-K-T - 4-Bay Hopper Car
30-75235 \$39.95

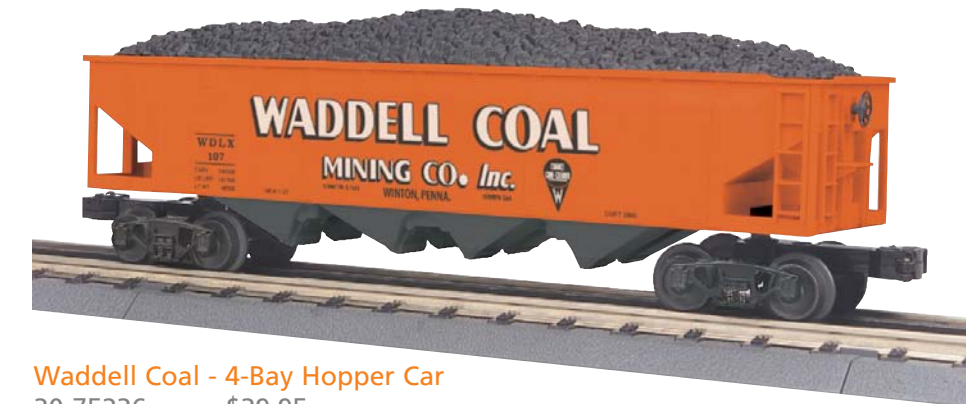

Waddell Coal - 4-Bay Hopper Car
30-75236 \$39.95

- Features**
- Intricately Detailed Durable ABS Body
 - Metal Wheels and Axles
 - Die-Cast 4-Wheel Trucks
 - Operating Die-Cast Metal Couplers
 - Colorful, Attractive Paint Schemes
 - Decorative Brake Wheels
 - Separate Metal Handrails
 - Fast-Angle Wheel Sets
 - Needle-Point Axles
 - Unit Measures: 11 3/4" x 2 1/2" x 2 3/4"
 - Operates On O-27 Curves



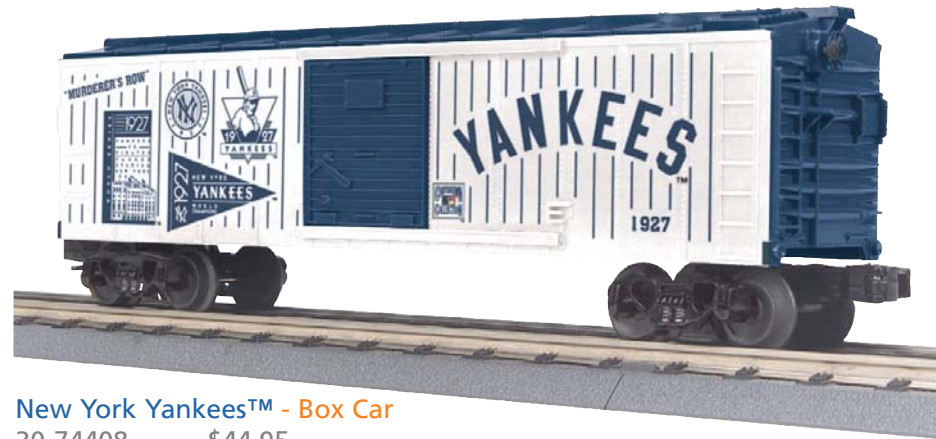

New York Yankees™ - Box Car
30-74408 \$44.95



Chicago Cubs™ - Box Car
30-74409 \$44.95



Western Maryland - Box Car
30-74412 \$39.95



Old Glory - Box Car
30-74413 \$39.95



Baltimore Orioles™ - Box Car
30-74410 \$44.95



Pittsburgh Pirates™ - Box Car
30-74411 \$44.95



Rudolph the Red-Nosed Reindeer® Misfit Toys™ - Box Car
30-74414 \$44.95

Features

- Intricately Detailed Durable ABS Body
- Metal Wheels and Axles
- Die-Cast 4-Wheel Trucks
- Operating Die-Cast Metal Couplers
- Colorful, Attractive Paint Schemes
- Decorative Brake Wheels
- Separate Metal Handrails
- Fast-Angle Wheel Sets
- Needle-Point Axles
- Unit Measures: 11 1/2" x 2 3/8" x 2 5/16"
- Operates On O-27 Curves



Major League Baseball trademarks and copyrights are used with permission of Major League Baseball Properties, Inc. MLB.com MTH Trains/MLBP 2006

Features

- Intricately Detailed Durable ABS Body
- Metal Wheels and Axles
- Die-Cast 4-Wheel Trucks
- Operating Die-Cast Metal Couplers
- Colorful, Attractive Paint Schemes
- Decorative Brake Wheels



Rudolph the Red-Nosed Reindeer © and © The Rudolph Company, L.P. "Rudolph the Red-Nosed Reindeer" animated program © Classic Media, Inc. All Rights Reserved.

- Separate Metal Handrails
- Fast-Angle Wheel Sets
- Needle-Point Axles
- Unit Measures: 11 1/2" x 2 3/8" x 2 5/16"
- Operates On O-27 Curves



Rounded Roof Box Car w/ Generator



Canadian National - Rounded Roof Box Car w/Generator
30-74434 \$44.95



New York Central - Rounded Roof Box Car w/Generator
30-74437 \$44.95



Bessemer & Lake Erie - Rounded Roof Box Car w/Generator
30-74436 \$44.95



Lehigh Valley - Rounded Roof Box Car w/Generator
30-74435 \$44.95

Features

- Intricately Detailed Durable ABS Body
- Metal Wheels and Axles
- Die-Cast 4-Wheel Trucks
- Operating Die-Cast Metal Couplers
- Colorful, Attractive Paint Schemes
- Fast-Angle Wheel Sets
- Needle-Point Axles
- Unit Measures: 11 5/8" x 2 1/2" x 3 7/16"
- Operates On O-27 Curves



40' Double Door Box Car



Pittsburgh Steelers Super Bowl X - 40' Double Door Box Car
30-74418 \$44.95



Southern - 40' Double Door Box Car
30-74415 \$39.95

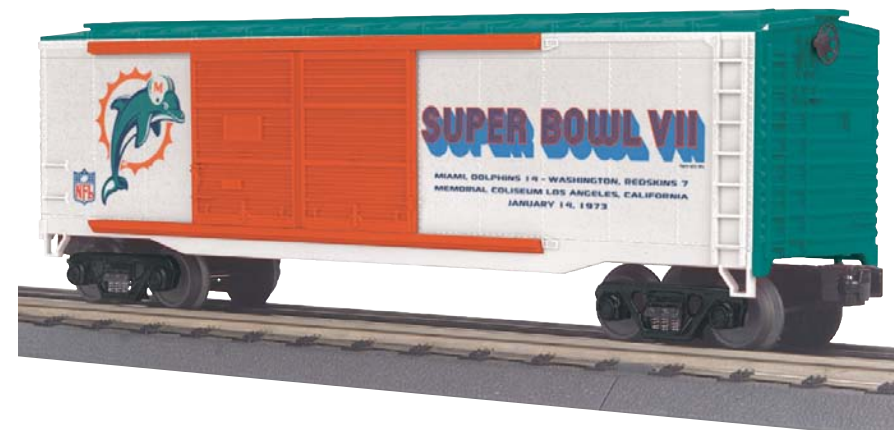

Miami Dolphins Super Bowl VII - 40' Double Door Box Car
30-74417 \$44.95



Grand Trunk Western - 40' Double Door Box Car
30-74416 \$39.95

Features

- Intricately Detailed Durable ABS Body
- Metal Wheels and Axles
- Die-Cast 4-Wheel Trucks
- Operating Die-Cast Metal Couplers
- Colorful, Attractive Paint Schemes
- Opening Car Doors
- Decorative Brake Wheels
- Fast-Angle Wheel Sets
- Needle-Point Axles
- Unit Measures: 11 1/2" x 2 1/2" x 3 7/16"
- Operates On O-31 Curves



©2006, NFL Enterprises LLC. NFL and the NFL Shield design are registered trademarks of the National Football League. The team names, logos and uniform designs are registered trademarks of the teams indicated.



40' High Cube Box Car



New York Mets™ - 40' High Cube Box Car
30-74419 \$49.95

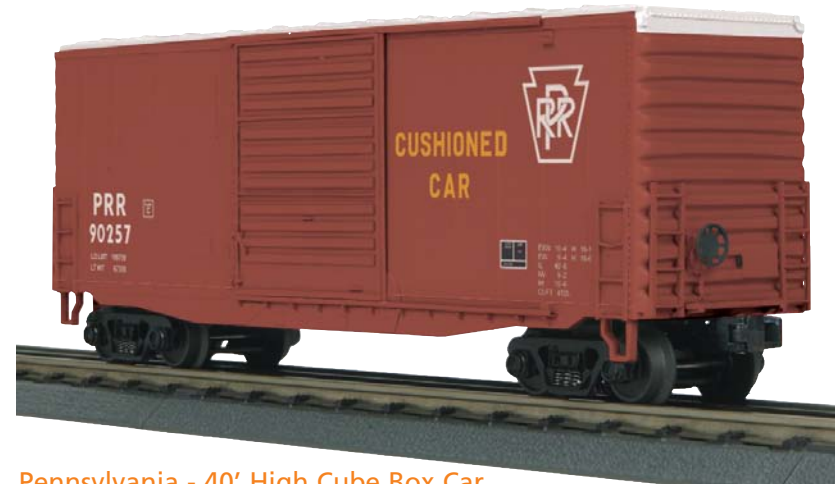

Pennsylvania - 40' High Cube Box Car
30-74428 \$44.95



New York Yankees™ - 40' High Cube Box Car
30-74420 \$49.95



Norfolk Southern - 40' High Cube Box Car
30-74429 \$44.95

Features

- Intricately Detailed Durable ABS Body
- Metal Wheels and Axles
- Die-Cast 4-Wheel Trucks
- Operating Die-Cast Metal Couplers
- Colorful, Attractive Paint Schemes
- Decorative Brake Wheels
- Opening Car Doors
- Separate Metal Handrails
- Fast-Angle Wheel Sets
- Needle-Point Axles
- Unit Measures: 11 1/2" x 2 3/8" x 2 5/16"
- Operates On O-27 Curves

 Major League Baseball trademarks and copyrights are used with permission of Major League Baseball Properties, Inc. MLB.com MTH Trains/MLBP 2006

Modern Reefer Car



CHROME PLATED Coors Light - Modern Reefer Car
30-78032 \$44.95



Budweiser - Modern Reefer Car
30-78033 \$44.95
© 2006 Anheuser-Busch, Inc. All Rights Reserved.



Killian's Red - Modern Reefer Car
30-78035 \$42.95

© 2006 Molson Coors Global Properties, LLC. Coors trademarks are properties of Molson Coors Global Properties, LLC, used under license by M.T.H. Electric Trains Limited Edition Adult Collectible-This licensed product is intended for purchase and enjoyment by individuals of legal purchase age for alcohol beverages.

Features

- Intricately Detailed Durable ABS Body
- Metal Wheels and Axles
- Die-Cast 4-Wheel Trucks
- Operating Die-Cast Metal Couplers
- Colorful, Attractive Paint Schemes
- Decorative Brake Wheels
- Separate Metal Handrails
- Fast-Angle Wheel Sets
- Needle-Point Axles
- Opening Car Doors
- Unit Measures: 11 1/2" x 2 3/8" x 2 5/16"
- Operates On O-27 Curves



Santa Fe - Modern Reefer Car
30-78034 \$42.95



Reefer Car



Esslinger's Lager - Reefer Car
30-78038 \$36.95



Acme Bock Beer - Reefer Car
30-78036 \$36.95

Features

- Metal Wheels and Axles
- Die-Cast 4-Wheel Trucks
- Operating Die-Cast Metal Couplers
- Colorful, Attractive Paint Schemes
- Decorative Brake Wheels
- Fast-Angle Wheel Sets
- Needle-Point Axles
- Unit Measures: 11 5/8" x 2 1/2" x 3 3/16"
- Operates On O-27 Curves



Chief Beer - Reefer Car
30-78037 \$36.95



Narragansett Ale - Reefer Car
30-78039 \$36.95



Airslide Hopper Car



Burlington Northern - Airslide Hopper Car
30-75237 \$39.95



Canadian National - Airslide Hopper Car
30-75238 \$39.95



Rock Island - Airslide Hopper Car
30-75240 \$39.95



Milwaukee Road - Airslide Hopper Car
30-75239 \$39.95

Features

- Intricately Detailed Durable ABS Body
- Metal Wheels and Axles
- Die-Cast 4-Wheel Trucks
- Operating Die-Cast Metal Couplers
- Colorful, Attractive Paint Schemes
- Decorative Brake Wheels
- Separate Metal Handrails
- Fast-Angle Wheel Sets
- Needle-Point Axles
- Unit Measures: 13" x 2 7/16" x 3 5/8"
- Operates On O-31 Curves

Tank Car

Modern Tank Car



Coors Light - Tank Car
30-73223 \$49.95

**CHROME
PLATED**



Pennsylvania - Tank Car
30-73221 \$42.95



Harley-Davidson® - Tank Car
30-73220 \$49.95



© 2006 H-D, All Rights Reserved. Manufactured by M.T.H. Electric Trains under license from Harley-Davidson Motor Company.
© 2006 M.T.H. Electric Trains, 7020 Columbia Gateway Drive, Columbia, Maryland 21046



Alaska - Tank Car
30-73222 \$42.95

- Features**
- Durable ABS Intricately Detailed Bodies
 - Chrome Plated Body Finish
 - Metal Wheels and Axles
 - Die-Cast 4-Wheel Trucks
 - Operating Die-Cast Metal Couplers
 - Intricately Detailed Durable ABS Body
 - Decorative Brake Wheels
 - Separate Metal Handrails
 - Fast-Angle Wheel Sets
 - Needle-Point Axles
 - Unit Measures: 10 3/8" x 2 3/8" 3 13/16"
 - Operates On O-27 Curves



- Features**
- Intricately Detailed Durable ABS Body
 - Metal Wheels and Axles
 - Die-Cast 4-Wheel Trucks
 - Operating Die-Cast Metal Couplers
 - Colorful, Attractive Paint Schemes
 - Separate Metal Handrails
 - Fast-Angle Wheel Sets
 - Needle-Point Axles
 - Unit Measures: 10 7/8" x 2 3/8" x 3 7/8"
 - Operates On O-27 Curves



John Deere
Modern Tank Car
30-73225 \$49.95

John Deere is a registered trademark of Deere & Company.



Conrail
Modern Tank Car
30-73227 \$44.95



Budweiser - Modern Tank Car
30-73226 \$49.95

"© 2006 Anheuser-Busch, Inc. All Rights Reserved."



Caterpillar® - Modern Tank Car
30-73224 \$49.95



© 2006 Caterpillar Cat, Caterpillar, their respective logos, Caterpillar Yellow, other marks and corporate identity used herein are trademarks of Caterpillar and may not be used without permission. Third-party trademarks are the property of their respective owners.

3-Dome Tank Car



Chesapeake & Ohio - 3-Dome Tank Car
30-73232 \$42.95



Bessemer & Lake Erie - 3-Dome Tank Car
30-73231 \$42.95

- Features**
- Intricately Detailed Durable ABS Body
 - Metal Wheels and Axles
 - Die-Cast 4-Wheel Trucks
 - Operating Die-Cast Metal Couplers
 - Colorful, Attractive Paint Schemes
 - Fast-Angle Wheel Sets
 - Needle-Point Axles
 - Unit Measures: 10 1/4" x 2 3/8" x 3 9/16"
 - Operates On O-27 Curves



Denver & Rio Grande - 3-Dome Tank Car
30-73233 \$42.95



Reading - 3-Dome Tank Car
30-73234 \$42.95

19th Century Wooden Tank Car



- Features**
- Intricately Detailed Durable ABS Body
 - Metal Wheels and Axles
 - Die-Cast 4-Wheel Trucks
 - Operating Die-Cast Metal Couplers
 - Colorful, Attractive Paint Schemes
 - Fast-Angle Wheel Sets
 - Needle-Point Axles
 - Near-Scale Proportions
 - Unit Measures: 9 11/16" x 2 1/4" x 3 1/4"
 - Operates On O-27 Curves



United States Leather
19th Century Wooden Tank Car
30-73228 \$39.95



Union Oil Company
19th Century Wooden Tank Car
30-73230 \$39.95



Heinz - Heinz
19th Century Wooden Tank Car
30-73219 \$44.95

A licensed product of H.J. Heinz Company, L.P. © 2006



Cleveland Tank Line
19th Century Wooden Tank Car
30-73229 \$39.95

Fire Car



Chessie - Fire Car
30-79172 \$49.95



Southern Pacific - Fire Car
30-79173 \$49.95



Canadian Pacific - Fire Car
30-79171 \$49.95



Western Maryland - Fire Car
30-79174 \$49.95

Features

- Intricately Detailed Durable ABS Body
- Metal Wheels and Axles
- Die-Cast 4-Wheel Trucks
- Operating Die-Cast Metal Couplers
- Colorful, Attractive Paint Schemes
- Fast-Angle Wheel Sets
- Needle-Point Axles
- Unit Measures: 11 11/16" x 2 5/16" x 4 3/4"
- Operates On O-27 Curves

Engineering Car



New York Central - Engineering Car
30-79169 \$44.95



Alaska - Engineering Car
30-79167 \$44.95



Pennsylvania - Engineering Car
30-79170 \$44.95



Chessie - Engineering Car
30-79168 \$44.95

Features

- Intricately Detailed Durable ABS Body
- Metal Wheels and Axles
- Die-Cast 4-Wheel Trucks
- Operating Die-Cast Metal Couplers
- Operating Interior Lighting
- Colorful, Attractive Paint Schemes
- Sliding Car Doors
- Fast-Angle Wheel Sets
- Needle-Point Axles
- Unit Measures: 11 1/2" x 2 1/2" x 4"
- Operates On O-27 Curves



Gondola Cars w/ Crates



John Deere - Gondola Car w/Crates
30-72003 \$44.95



Harley-Davidson® - Gondola Car w/Crates
30-72001 \$44.95



Caterpillar® - Gondola Car w/Crates
30-72002 \$44.95



NASA - Gondola Car w/Crates
30-72004 \$39.95

Features

- Intricately Detailed Durable ABS Body
- Metal Wheels and Axles
- Die-Cast 4-Wheel Trucks
- Operating Die-Cast Metal Couplers
- Colorful, Attractive Paint Schemes
- Decorative Brake Wheels
- Fast-Angle Wheel Sets
- Needle-Point Axles
- (3) Removable Crates
- Unit Measures: 11 15/16" x 2 3/16" x 1 11/16"
- Operates On O-27 Curves



© 2006 Caterpillar
Cat, Caterpillar, their respective logos, Caterpillar Yellow, other marks and corporate identity used herein are trademarks of Caterpillar and may not be used without permission. Third-party trademarks are the property of their respective owners.

John Deere is a registered trademark of Deere & Company.



© 2006 H-D, All Rights Reserved. Manufactured by M.T.H. Electric Trains under license from Harley-Davidson Motor Company.
© 2006 M.T.H. Electric Trains, 7020 Columbia Gateway Drive, Columbia, Maryland 21046



Bunk Car



Pittsburgh & Lake Erie - Bunk Car
30-79161 \$44.95



CSX - Bunk Car
30-79160 \$44.95



Canadian Pacific - Bunk Car
30-79159 \$44.95



Western Maryland - Bunk Car
30-79162 \$44.95

Features

- Intricately Detailed Durable ABS Body
- Metal Wheels and Axles
- Die-Cast 4-Wheel Trucks
- Operating Die-Cast Metal Couplers
- Operating Interior Lighting
- Colorful, Attractive Paint Schemes
- Sliding Car Doors
- Fast-Angle Wheel Sets
- Needle-Point Axles
- Unit Measures: 11 1/2" x 2 1/2" x 4"
- Operates On O-27 Curves

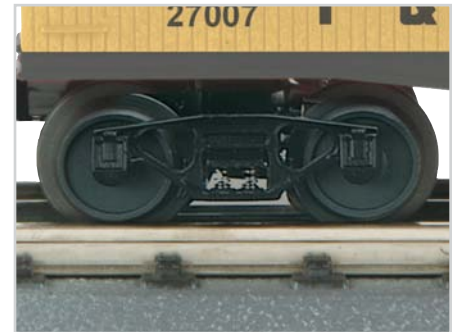

Flat Cars w/ Trailer



Washington Nationals™ - Flat Car w/ Trailer
30-76239 \$49.95



Baltimore Ravens - Flat Car w/ Trailer
30-76241 \$49.95



Washington Redskins - Flat Car w/ Trailer
30-76240 \$49.95



Budweiser - Flat Car w/ Trailer
30-76242 \$49.95

Features

- Intricately Detailed Durable ABS Body
- Metal Wheels and Axles
- Die-Cast 4-Wheel Trucks
- Operating Die-Cast Metal Couplers
- Colorful, Attractive Paint Schemes
- Decorative Brake Wheels
- Fast-Angle Wheel Sets
- Needle-Point Axles
- ABS Detailed Trailer
- Unit Measures: 11 5/8" x 2 1/4" x 3 3/4"
- Operates On O-27 Curves



Major League Baseball trademarks and copyrights are used with permission of Major League Baseball Properties, Inc. MLB.com MTH Trains/MLBP 2006



©2006, NFL Enterprises LLC. NFL and the NFL Shield design are registered trademarks of the National Football League. The team names, logos and uniform designs are registered trademarks of the teams indicated.

© 2006 Anheuser-Busch, Inc. All Rights Reserved.



Flat Cars w/ Load



Santa Fe
Flat Car w/ Camping Trailer
30-76251 \$42.95



Milwaukee Road
Flat Car w/ (2) Motor Homes
30-76252 \$42.95



New Haven - Flat Car w/Rescue Boat
30-76249 \$39.95



Alaska
Flat Car w/ (2) Car Trailers
30-76253 \$42.95



Norfolk & Western - Flat Car w/Fishing Boat
30-76250 \$39.95

Features

- Intricately Detailed Durable ABS Body
- Metal Wheels and Axles
- Operating Interior Lighting
- Die-Cast 4-Wheel Trucks
- Colorful, Attractive Paint Schemes
- Operating Die-Cast Metal Couplers
- Fast-Angle Wheel Sets
- Needle-Point Axles
- (2) Die-Cast Car Trailers
- Unit Measures: 11 5/8" x 2 1/4" x 3 3/4"
- Operates On O-31 Curves



Ore Cars



Milwaukee Road - Ore Car
30-75242 \$39.95



Union Pacific - Ore Car
30-75244 \$39.95

Features

- Intricately Detailed Durable ABS Body
- Metal Wheels and Axles
- Die-Cast 4-Wheel Trucks
- Operating Die-Cast Metal Couplers
- Colorful, Attractive Paint Schemes
- Decorative Brake Wheels
- Separate Metal Handrails
- Fast-Angle Wheel Sets
- Needle-Point Axles
- Unit Measures: 11 1/2" x 2 3/8" x 2 5/16"
- Operates On O-27 Curves



Illinois Central - Ore Car
30-75241 \$39.95



Monon - Ore Car
30-75243 \$39.95



American Crane Cars



Illinois Central - American Crane Car
30-79165 \$59.95



Burlington Northern - American Crane Car
30-79163 \$59.95



NASA - American Crane Car
30-79166 \$59.95

Features

- Intricately Detailed Durable ABS Body
- Metal Wheels and Axles
- Die-Cast 4-Wheel Trucks
- Operating Die-Cast Metal Couplers
- Colorful, Attractive Paint Schemes
- Decorative Brake Wheels
- Fast-Angle Wheel Sets
- Needle-Point Axles
- Manually Operated Crane Hook & Boom
- Unit Measures: 17 5/8" x 2 5/8" x 4"
- Operates On O-31 Curves

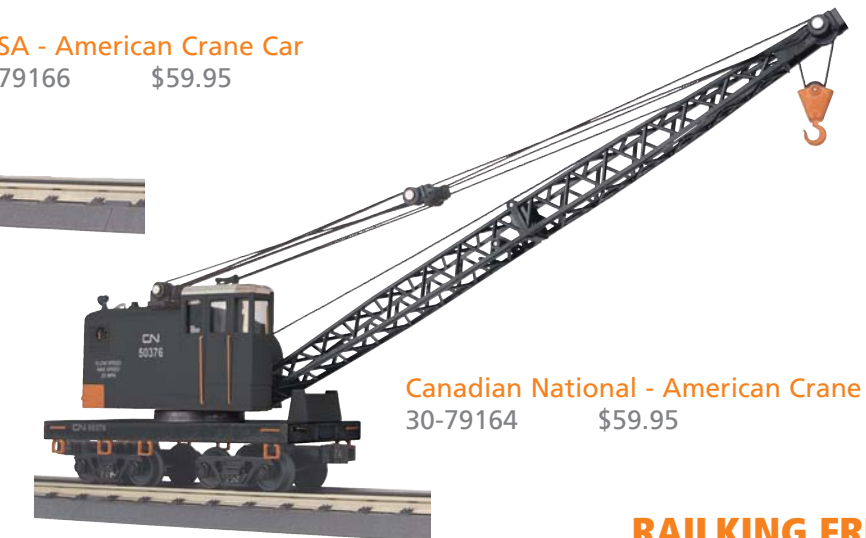

Canadian National - American Crane Car
30-79164 \$59.95

Flat Cars w/ Load

Union Pacific
Flat Car w/(2) Ford Rancheros
30-76247 \$39.95



New York Central
Flat Car w/(2) Chevy Tahoes
30-76248 \$39.95



Caterpillar®
Flat Car w/432E Backhoe
30-76243 \$44.95



© 2006 Caterpillar
Cat, Caterpillar, their respective logos, Caterpillar Yellow, other marks and corporate identity used herein are trademarks of Caterpillar and may not be used without permission. Third-party trademarks are the property of their respective owners.



Lehigh Valley
Flat Car w/(2) '58 Edsel Citations
30-76246 \$39.95



Jersey Central
Auto Carrier Flat Car w/(4) Ford Capris
30-76245 \$59.95

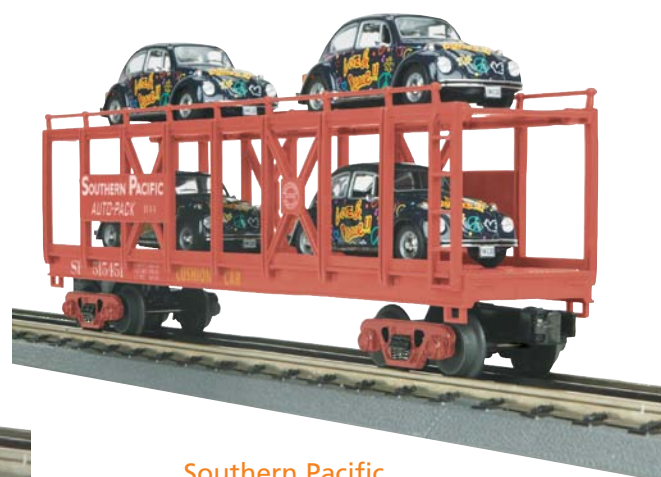

Southern Pacific
Auto Carrier Flat Car w/(4) VW Beetles
30-76244 \$59.95

Features

- Intricately Detailed Durable ABS Body
- Metal Wheels and Axles
- Die-Cast 4-Wheel Trucks
- Operating Die-Cast Metal Couplers
- Colorful, Attractive Paint Schemes
- Decorative Brake Wheels
- Fast-Angle Wheel Sets
- Needle-Point Axles
- (2) Die-Cast Vehical Loads
- Flat Cars Measure: 11 3/4" x 2 5/16" x 1 15/16"
- Auto Carriers Measure: 11 11/16" x 2 5/16" x 3 1/2"
- Operates On O-27 Curves

Gondola Car with Cover



Seaboard - Gondola Car w/Cover
30-72008 \$39.95



Chicago NorthWestern - Gondola Car w/Cover
30-72005 \$39.95



Pittsburgh & Lake Erie - Gondola Car w/Cover
30-72007 \$39.95



Jersey Central - Gondola Car w/Cover
30-72006 \$39.95

Features

- Intricately Detailed Durable ABS Body
- Metal Wheels and Axles
- Die-Cast 4-Wheel Trucks
- Operating Die-Cast Metal Couplers
- Colorful, Attractive Paint Schemes
- Decorative Brake Wheels
- Fast-Angle Wheel Sets
- Needle-Point Axles
- Removable Gondola Cover
- Unit Measures: 11 15/16" x 2 3/16" x 1 11/16"
- Operates On O-27 Curves



Offset Steel Caboose



Santa Fe - Offset Steel Caboose
30-77129 \$49.95



MKT - Offset Steel Caboose
30-77127 \$49.95



Norfolk & Western - Offset Steel Caboose
30-77128 \$49.95



Atlantic Coast Line - Offset Steel Caboose
30-77126 \$49.95



N5c Caboose



John Deere - N5c Caboose
30-77122 \$54.95
John Deere is a registered trademark of Deere & Company.



Pennsylvania - N5c Caboose
30-77124 \$49.95



CSX - N5c Caboose
30-77125 \$49.95



Pennsylvania - N5c Caboose
30-77123 \$49.95



Features

- Intricately Detailed Durable ABS Body
- Metal Wheels and Axles
- Die-Cast 4-Wheel Trucks
- Operating Die-Cast Metal Couplers
- Colorful, Attractive Paint Schemes
- Fast-Angle Wheel Sets
- Needle-Point Axles
- Near-Scale Proportions
- Overhead Interior Lighting
- Unit Measures: 10 1/4" x 2 1/2" x 4 1/4"
- Operates On O-27 Curves

Features

- Intricately Detailed Durable ABS Body
- Metal Wheels and Axles
- Die-Cast 4-Wheel Trucks
- Operating Die-Cast Metal Couplers
- Colorful, Attractive Paint Schemes
- Fast-Angle Wheel Sets
- Needle-Point Axles
- Near-Scale Proportions
- Overhead Interior Lighting
- Detailed Car Interior
- Unit Measures: 9 1/8" x 2 5/8" x 4 1/4"
- Operates On O-27 Curves

RailKing Passenger Cars

RailKing Passenger Cars are available in the popular 60' Streamlined and Madison style bodies. Configured in 4-car, 2-car and single-car configurations, each type features car interior detail, overhead interior lighting, end-of-car diaphragms and intricate under-car detail. All configurations are mounted atop die-cast metal 4 or 6-wheel trucks with operating metal couplers, metal wheels and metal axles.

Designed to bring authenticity and smooth performing operation to any O Gauge layout, modelers will find no finer O Gauge value than RailKing Passenger Cars.

Union Pacific Forty Niner



4-Car 60' Streamlined ABS Passenger Set
30-67364 \$199.95

60' Streamlined ABS Full-Length Vista Dome Car

30-67367 \$54.95



2-Car 60' Streamlined ABS Sleeper/Diner
30-67365 \$99.95



60' Streamlined ABS Sleeper Car
30-67366 \$49.95

Union Pacific



4-Car 60' Streamlined ABS Passenger Set
30-67368 \$199.95



2-Car 60' Streamlined ABS Sleeper/Diner
30-67369 \$99.95



60' Streamlined ABS Sleeper Car
30-67370 \$49.95



60' Streamlined ABS Full-Length Vista Dome Car
30-67371 \$54.95

New York Central



4-Car 60' Streamlined ABS Passenger Set
30-67348 \$199.95

2-Car 60' Streamlined ABS Sleeper/Diner

30-67349 \$99.95



60' Streamlined ABS Full-Length Vista Dome Car

30-67351 \$54.95

60' Streamlined ABS Coach Car

30-67350 \$49.95



New York Central Dreyfuss



2-Car 60' Streamlined ABS Sleeper/Diner
30-67345 \$99.95



60' Streamlined ABS Full-Length Vista Dome Car
30-67347 \$54.95



4-Car 60' Streamlined ABS Passenger Set
30-67344 \$199.95

Features

- Durable ABS Intricately Detailed Bodies
- Metal Wheels and Axles
- Overhead Interior Lighting
- Die-Cast 4-Wheel Trucks
- Operating Die-Cast Metal Couplers
- Colorful, Attractive Paint Schemes
- End-of-Car Diaphragms
- Fast-Angle Wheel Sets
- Needle-Point Axles
- Detailed Car Interiors
- 4-Car Sets Feature: (1) Baggage, (2) Sleepers, (1) Boat Tail Observation
- 4-Car Set Measures: 68 3/4" x 2 5/8" x 3 5/16"
- Sleeper/Diner Set Measures: 34 6/16" x 2 5/8" x 3 5/16"
- Sleeper Car Measures: 16 11/16" x 2 1/2" x 3 5/16"
- Vista Dome Measures: 16 11/16" x 2 1/2" x 3 13/16"
- Operates On O-31 Curves

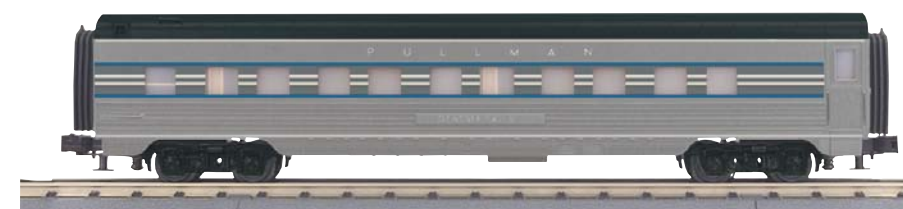

60' Streamlined ABS Sleeper Car
30-67346 \$49.95

RailKing Passenger Cars



Santa Fe



60' Streamlined ABS Sleeper Car
30-67376 \$49.95

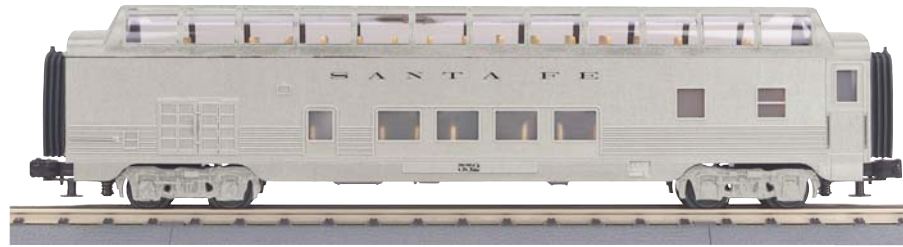

60' Streamlined ABS Full-Length Vista Dome Car
30-67377 \$54.95



2-Car 60' Streamlined ABS Sleeper/Diner
30-67375 \$99.95

Texas Special



2-Car 60' Streamlined ABS Sleeper/Diner
30-67372 \$99.95



60' Streamlined ABS Sleeper Car
30-67373 \$49.95



60' Streamlined ABS Full-Length Vista Dome Car
30-67374 \$54.95

Canadian Pacific



60' Streamlined ABS Coach Car
30-67342 \$49.95



2-Car 60' Streamlined ABS Sleeper/Diner
30-67341 \$99.95



4-Car 60' Streamlined ABS Passenger Set
30-67340 \$199.95



60' Streamlined ABS Full-Length Vista Dome Car
30-67343 \$54.95

Pennsylvania



2-Car 60' Streamlined ABS Sleeper/Diner
30-67353 \$99.95



60' Streamlined ABS Full-Length Vista Dome Car
30-67355 \$54.95



4-Car 60' Streamlined ABS Passenger Set
30-67352 \$199.95



60' Streamlined ABS Coach Car
30-67354 \$49.95

Pennsylvania



60' Streamlined ABS Coach Car
30-67358 \$49.95



2-Car 60' Streamlined ABS Sleeper/Diner
30-67357 \$99.95



60' Streamlined ABS Full-Length Vista Dome Car
30-67359 \$54.95



4-Car 60' Streamlined ABS Passenger Set
30-67356 \$199.95

Southern



2-Car 60' Streamlined ABS Sleeper/Diner
30-67361 \$99.95



60' Streamlined ABS Full-Length Vista Dome Car
30-67363 \$54.95



60' Streamlined ABS Coach Car
30-67362 \$49.95



4-Car 60' Streamlined ABS Passenger Set
30-67360 \$199.95

Premier

O SCALE'S FINEST COMBINATION OF DETAIL, REALISM AND PERFORMANCE



Since 1992, M.T.H.'s Premier Line has offered O Gauge modelers exciting and innovative products never before seen in 1/48th proportions.

No other manufacturer can lay claim to as many of the unique and exciting die-cast steam locomotives, heavy duty diesel engines, rolling stock, or passenger consists as M.T.H. has produced during the past 16 years. Look closely at any Premier Line model and we think you'll find a combination of superb detailing, prototype accuracy, and smooth, dependable operation that is unmatched by any other manufacturer.

PROTO-SCALE 3-2™

Operate on 3-Rail or 2-Rail Track with AC or DC Power!

All Premier steam engines in this catalog, and a number of diesels, are equipped with Proto-Scale 3-2™, a unique M.T.H. feature that allows you to run the same engine on 2-rail or 3-rail track, under AC or DC power. Engines cataloged with hi-rail wheels are intended primarily for 3-rail operators, while engines with scale wheels are aimed at 2-rail DC operators as well as 3-rail AC modelers looking for more scale realism.

Convert your Hi-Rail Wheel equipped diesel locomotive power trucks to a Scale Wheeled version. Requires a Proto-Scale 3-2™ power truck (sold with 2006 models only).

Scale Wheel Kits

Proto-Scale 3-2™ 4-Wheel Truck Scale Wheel Set Kit
20-89005 \$24.95

Proto-Scale 3-2™ 6-Wheel Truck Scale Wheel Set Kit
20-89006 \$29.95

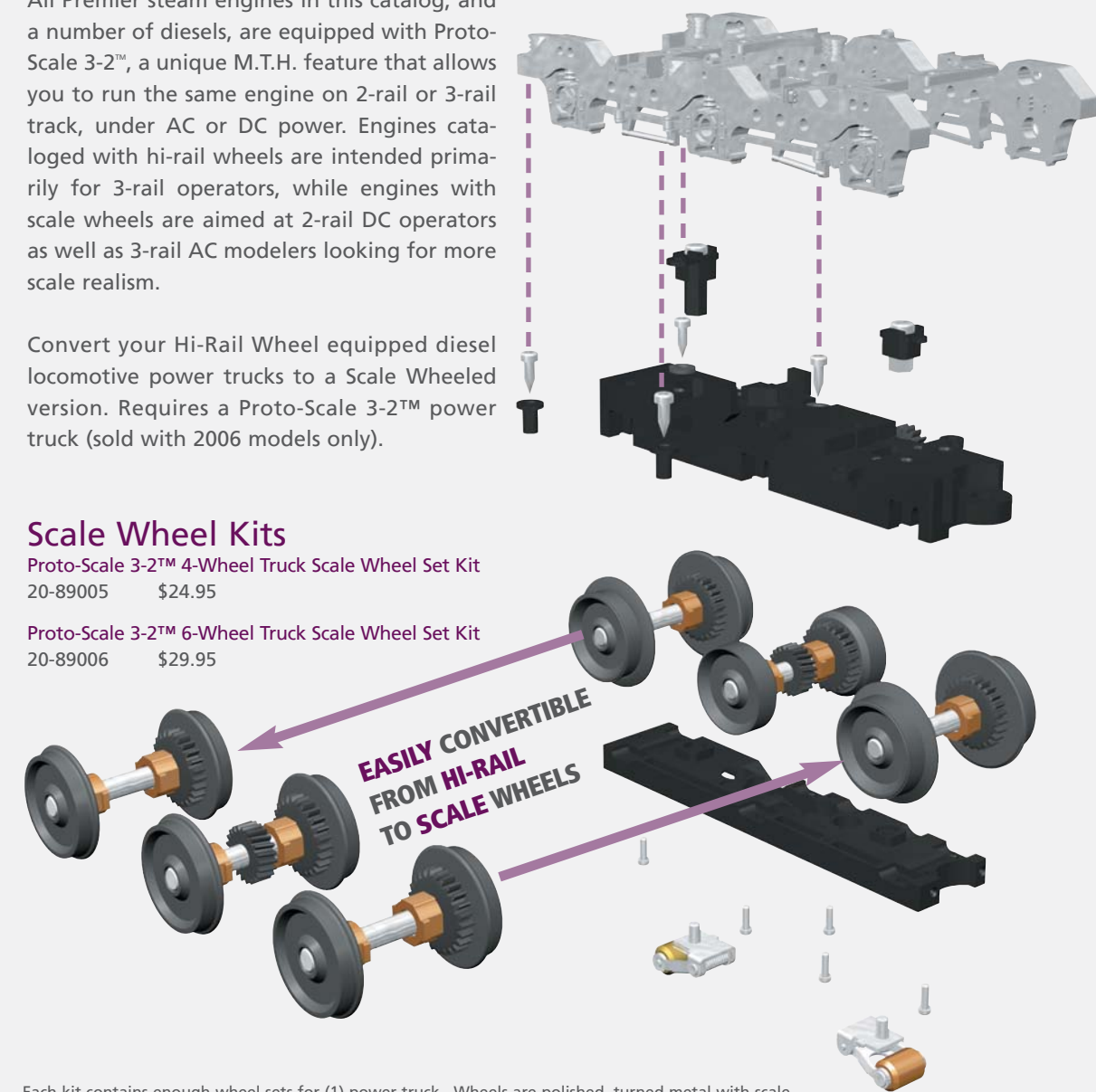

Each kit contains enough wheel sets for (1) power truck. Wheels are polished, turned metal with scale treads and flange heights. Premounted on metal axles with one insulated side for use on 2-rail O Scale track systems. One wheel set in each kit contains premounted drive gears.

2-8-2 L-1 Mikado Steam Engine

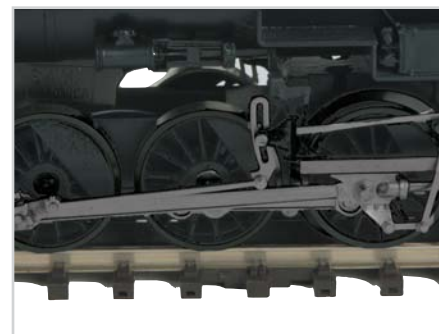

Built between 1914 and 1919, the Pennsylvania Railroad's fleet of L1s Mikados hauled freight through two world wars and served until the end of steam in 1957. Designed by the railroad's own mechanical engineers in tandem with the passenger-service K4s Pacifics, the Mikes replaced 2-8-0 Consolidations as Pennsy's main line freight power.

The Mikado followed the Pennsy's practice of testing a locomotive design thoroughly and then building a standardized engine in large numbers. The L1s class - 574 strong - and the 425 class K4s Pacifics shared an identical boiler and many other common parts, giving shop crews nearly 1000 locos that were largely the same. While the "s" in L1s stood for superheater, the Mikados had few other modern appliances when built. The Walschaert valve gear was reversed by a heavy screw mechanism and the large firebox was hand shoveled.

By the early 1930's the Interstate Commerce Commission had mandated the use of power reverse gear. The addition of this mechanism to the engineer's side of the engine pushed the air tank to the front of the boiler, giving the L1s the characteristic face it wore in later years. Many, but not all, Mikados eventually received coal stokers to feed the firebox, adding about 1000 horses to their original potential of about 2700 horsepower. Over level or moderately hilly terrain, an L1s could handle a 70 - 80 car freight train. In one instance, a Mike hauled two GG1's with their two passenger consists through a 10-mile stretch after the overhead wire became disabled.

Just as the Mikados displaced lesser 2-8-0's, however, they were themselves bumped from mainline service by the advent of Decapods and other larger power. The Mikado fleet spent many of its later years going in and out of mothballs as the Pennsy's freight business ebbed and flowed. When every piece of available power was needed during World War II, Mikados that were still hand-fired had two firemen shoveling coal. Many of the dependable Mikes worked in branch line, helper, and even railfan service until the end of steam on the Pennsylvania Railroad.

New to the Premier line for 2007, MTH announces the Pennsylvania Railroad L1s Mikado, accurately scaled from engine #520 that resides today in the Railroad Museum of Pennsylvania. Our model will feature the superb detailing, realistic and vibrant sounds, and precise throttle control that characterize all Premier Proto-Sound® 2.0 locomotives.



Pennsylvania - 2-8-2 L-1 Mikado Steam Engine w/ Proto-Sound® 2.0

20-3180-1	Hi-Rail Wheels	\$899.95
20-3180-2	Scale Wheels	\$899.95

NEW TOOLING!



Interstate - 2-8-2 L-1 Mikado Steam Engine w/ Proto-Sound® 2.0

20-3197-1	Hi-Rail Wheels	\$899.95
20-3197-2	Scale Wheels	\$899.95

NEW TOOLING!



Lehigh & New England - 2-8-2 L-1 Mikado Steam Engine w/ Proto-Sound® 2.0

20-3199-1	Hi-Rail Wheels	\$899.95
20-3199-2	Scale Wheels	\$899.95

NEW TOOLING!



Cambria & Indiana - 2-8-2 L-1 Mikado Steam Engine w/ Proto-Sound® 2.0

20-3200-1	Hi-Rail Wheels	\$899.95
20-3200-2	Scale Wheels	\$899.95

NEW TOOLING!

Features

- Die-Cast Boiler and Tender Body
- Die-Cast Metal Chassis
- Authentic Paint Scheme
- Metal Wheels and Axles
- Constant Voltage Headlight
- Die-Cast Truck Sides
- Precision Pittman® Flywheel Equipped Motor
- Remote Controlled Proto-Coupler™
- Engineer and Fireman Figures
- Operating Firebox Glow
- Metal Handrails and Decorative Bell
- Decorative Metal Whistle
- Operating Marker Lights
- Lighted Cab Interior
- Synchronized Puffing ProtoSmoke™ System
- Operating Tender Back-up Light
- Proto-Scale 3-2™ 3-Rail/2-Rail Conversion Capable
- Locomotive Speed Control
- Proto-Sound® 2.0 With The Digital Command System Featuring Freight Yard Proto-Effects™
- Unit Measures: 21 3/4" x 2 1/2" x 3 7/8"
- Hi-Rail Wheels Operate On O-42 Curves
- Scale Wheels Operate on 42" Radius Curves

0-4-0 Steam Switchers

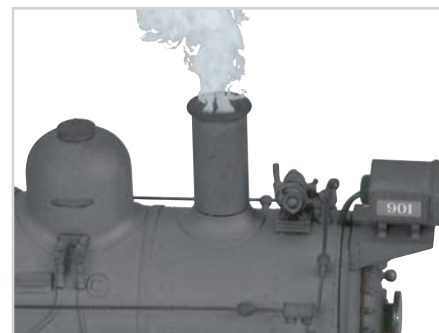

By World War I the 0-4-0 wheel arrangement had largely slipped into the history books, and six- or eight-coupled steam switchers were the norm on most railroads. The self-proclaimed Standard Railroad of the World, however - stubbornly independent and known for its home-grown motive power - in 1916 began building perhaps the most modern 0-4-0's ever constructed. Built in the Pennsylvania Railroad's Juniata shops, the A5s was, in Al Stauffer's words, "a junior edition of mammoth road power," with modern appliances and machinery details never before seen on an 0-4-0. The "s" in the engine's name stood for "super-heater;" other modern features included Walschaert valve gear and power reverse. The large vertical tanks under the cab were air brake reservoirs. A sloping rear tender deck allowed better visibility for backup moves, and the locomotive of course had the Pennsy's characteristic Belpaire firebox.

The diminutive 0-4-0's were right at home in the narrow streets and tight corners of industrial and wharf areas, particularly in Philadelphia, New York, and Baltimore. Because they worked at slow speeds among tightly-spaced buildings, many A5's carried a fire hose in a metal box to enable them to help out in an emergency. Some were also used as yard goats to move dead engines in roundhouse areas. The Pennsylvania refurbished A5s No. 94 for its historical locomotive collection, and that switcher - or "shifter" in Pennsy parlance - resides today in the Railroad Museum of Pennsylvania in Strasburg, PA.

The A5s returns to the Premier line in 2007 accompanied by a new, non-Pennsy version; a standard radial firebox on the new version replaces the squared-off Pennsy Belpaire firebox on the A5s. Thanks to Proto-Sound® 2.0, our super-detailed 0-4-0s offer all the features you'd want in a steam switcher: smooth, steady operation down to 3 scale miles per hour, remote Proto-Couplers™ front and rear, chuffing sounds and puffing smoke synchronized with the drivers at a correct four chuffs per revolution, adjustable smoke intensity, great pulling power, directional lighting, and authentic sounds.



NEW TOOLING!
Southern - 0-4-0 Switcher Steam Engine w/Proto-Sound® 2.0
20-3263-1 Hi-Rail Wheels \$599.95
20-3263-2 Scale Wheels \$599.95

NEW TOOLING!
Santa Fe - 0-4-0 Switcher Steam Engine w/Proto-Sound® 2.0
20-3262-1 Hi-Rail Wheels \$599.95
20-3262-2 Scale Wheels \$599.95



NEW TOOLING!
Chesapeake & Ohio
0-4-0 Switcher Steam Engine w/Proto-Sound® 2.0
20-3264-1 Hi-Rail Wheels \$599.95
20-3264-2 Scale Wheels \$599.95

Pennsylvania - 0-4-0 A-5 Switcher Steam Engine w/Proto-Sound® 2.0
20-3265-1 Hi-Rail Wheels \$599.95
20-3265-2 Scale Wheels \$599.95



NEW TOOLING! New York Central - 0-4-0 Switcher Steam Engine w/Proto-Sound® 2.0
20-3261-1 Hi-Rail Wheels \$599.95
20-3261-2 Scale Wheels \$599.95

Features

- Die-Cast Boiler, Cab, and Tender Body
- 1:48 Scale Proportions
- Die-Cast Metal Chassis
- Metal Wheels and Axles
- Constant Voltage Headlight
- Die-Cast Truck Sides
- Engineer and Fireman Figures
- Operating Firebox Glow
- Metal Handrails and Decorative Bell
- Decorative Metal Whistle
- Operating Tender Back-up Light
- Locomotive Speed Control
- Synchronized Puffing ProtoSmoke™ System
- Precision Flywheel Equipped Motor
- Proto-Scale 3-2™ 3-Rail/2-Rail Conversion Capable
- (2) Remote Controlled Proto-Couplers™
- Proto-Sound® 2.0 With The Digital Command System Featuring Freight Yard Proto-Effects™
- Unit Measures: 15 3/4" x 3 3/4" x 2 3/4"
- Hi-Rail Wheels Operate On O-31 Curves
- Scale Wheels Operate on 18" Radius Curves

2-6-6-4 Class A Steam Engine



The Norfolk and Western Railway was a coal-hauling line of modest extent, with most of its trackage in three states: Virginia, West Virginia, and Ohio. Yet among railfans and modelers, the N&W has achieved recognition far out of proportion to its size. One reason was the N&W's loyalty to steam. Modern reproductions aside, the last steam locomotives made in the United States were built in the N&W's Roanoke shops, and as late as 1955 there was not a single diesel on the property.

A second reason is what N&W fans call the "holy trinity of steam": Classes J, Y6, and A, arguably three of the finest steamers ever made. The Class A 2-6-6-4 was perhaps as close to a perfect all-around locomotive as was ever built. Smooth, fast, and powerful, the A was a greyhound that could race a heavy passenger train along at 70 mph or hustle 200 loaded hoppers over level track. The 43 Class A engines built from 1936-50, along with contemporaries like the UP Challenger and C&O Greenbrier, were the tail end of the "super-power" era of steam technology, in which the external combustion engine was refined to its finest form. After the A and its contemporaries came only futile attempts to stop the onslaught of the diesel.

The Class A returns to the Premier line in 2007, offered for the first time with Proto-Sound 2.0 and featuring additional detailing and upgraded sounds — and ready to haul your longest freight or passenger consists.



Features

- Die-Cast Boiler and Tender Body
- 1:48 Scale Proportions
- Die-Cast Metal Chassis
- Authentic Paint Scheme
- Metal Wheels and Axles
- Constant Voltage Headlight
- Die-Cast Truck Sides
- Precision Pittman® Flywheel Equipped Motor
- Locomotive Speed Control
- Remote Controlled Proto-Coupler™
- Engineer and Fireman Figures
- Operating Firebox Glow
- Metal Handrails and Decorative Bell
- Decorative Metal Whistle
- Operating Marker Lights
- Lighted Cab Interior
- Synchronized Puffing ProtoSmoke™
- Operating Tender Back-up Light
- Illuminated Number Boards
- Scale Front Coupler w/Interchangeable O Gauge Coupler For Doubleheading
- Separately Applied Piping & Assorted Details
- Realistic & Authentic Builder's Plates
- Opening Cab Roof Hatch
- Sliding Cab Window Glass
- Opening Tender Water Hatches w/Proto-Sound® 2.0 Control Switches Inside
- Proto-Sound 2.0 With The Digital Command System Featuring Freight Yard Proto-Effects™
- Unit Measures: 26 1/8" x 2 5/8" x 4"
- Operates On O-72 Curves



Norfolk & Western - 2-6-6-4 Class A Steam Engine
20-3271-1 Proto-Sound® 2.0 \$1399.95

0-6-0 USRA Steam Switcher

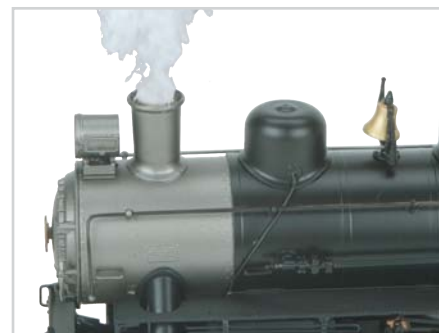

During World War I, Uncle Sam nationalized the railroads when they proved unequal to the task of moving massive amounts of men and material for the war effort. The agency that ran the trains was the United States Railroad Administration, or USRA, and one of its chief accomplishments was the creation of 12 steam engine designs that lasted for decades. According to the American Society of Mechanical Engineers, USRA locomotives were "the first successful standardization of American motive power" - and the only standard designs until the diesel era.

With 255 engines delivered to 23 railroads, production numbers for the government-issue 0-6-0 were the second-highest of any USRA design. And more than any other USRA engine, the six-coupled switcher was found from coast to coast, from Maine to Texas, and on railroads large and small. Owners were generally quite pleased with the quality of the government's design, and many 0-6-0s lasted into the 1950s.

Constructed with numerous added-on detail parts, the USRA 0-6-0 joins the Premier line for 2007, decorated and correctly numbered for five of the original owners. Only M.T.H. offers you this combination of prototype realism and all the operating features you'd want in a steam switcher: smooth, steady operation down to 3 scale miles per hour; remote Proto-Couplers™ front and rear; chuffing sounds and puffing smoke synchronized with the drivers at a correct four chuffs per revolution; adjustable smoke intensity; great pulling power; directional lighting; and authentic sounds.



Grand Trunk Western - 0-6-0 USRA Steam Engine w/Proto-Sound® 2.0 **NEW TOOLING!**
 20-3267-1 Hi-Rail Wheels \$599.95
 20-3267-2 Scale Wheels \$599.95



Seaboard Air Line - 0-6-0 USRA Steam Engine w/Proto-Sound® 2.0 **NEW TOOLING!**
 20-3268-1 Hi-Rail Wheels \$599.95
 20-3268-2 Scale Wheels \$599.95



Chicago & NorthWestern - 0-6-0 USRA Steam Engine w/Proto-Sound® 2.0 **NEW TOOLING!**
 20-3266-1 Hi-Rail Wheels \$599.95
 20-3266-2 Scale Wheels \$599.95



NEW TOOLING!
Pittsburgh & West Virginia - 0-6-0 USRA Steam Engine w/Proto-Sound® 2.0
 20-3269-1 Hi-Rail Wheels \$599.95
 20-3269-2 Scale Wheels \$599.95

Features

- Die-Cast Boiler, Cab, and Tender Body
- 1:48 Scale Proportions
- Die-Cast Metal Chassis
- Authentic Paint Schemes
- Metal Wheels and Axles
- Constant Voltage Headlight
- Die-Cast Truck Sides
- Engineer and Fireman Figures
- Operating Firebox Glow
- Metal Handrails and Decorative Bell
- Decorative Metal Whistle
- Operating Tender Marker Lights

- Lighted Cab Interior
- Operating Tender Back-up Light
- Precision Flywheel Equipped Motor
- Locomotive Speed Control
- Synchronized Puffing ProtoSmoke™
- (2) Remote Controlled Proto-Couplers™
- Proto-Sound® 2.0 With The Digital Command System Featuring Freight Yard Proto-Effects™
- Proto-Scale 3-2™ 3-Rail/2-Rail Conversion Capable
- Unit Measures: 17 1/8" x 2 3/8" x 3 5/8"

- Hi-Rail Wheels Operate On O-31 Curves
- Scale Wheels Operate on 18" Radius Curves

Union Pacific - 0-6-0 USRA Steam Engine w/Proto-Sound® 2.0
 20-3270-1 Hi-Rail Wheels \$599.95
 20-3270-2 Scale Wheels \$599.95



4-6-6-4 Z-6 Challenger Steam Engine

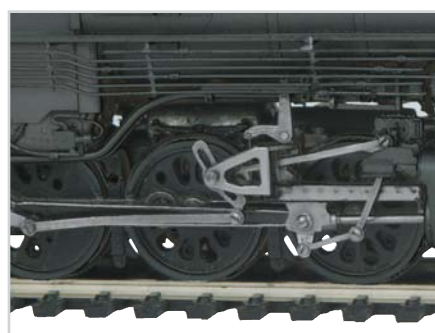
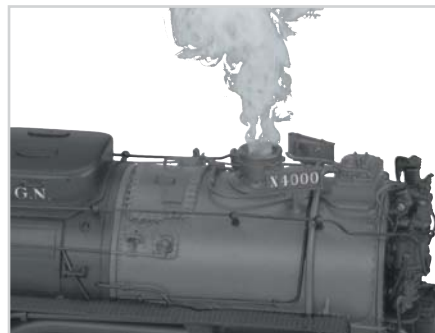

In the early part of the twentieth century, most freight moved in relatively slow "drag" freight trains, and speed was secondary to just getting the goods delivered. The introduction of "super-power" steam technology in the 1920's, however, enabled builders to create freight locomotives that combined speed and power. Perhaps the zenith of the fast freight engine was the 4-6-6-4 Challenger, first conceived by the Union Pacific Railroad and American Locomotive Works in the mid-1930s. The Northern Pacific liked what it saw taking shape at Alco and ordered its own, even bigger Challengers. One reason the NP engines were larger was the railroad's use of large fireboxes to burn low-quality Rosebud coal mined online in Montana — coal that at least one fireman described as "damned close to dirt." The first dozen Z-6 Challengers arrived in 1936, just months after the UP received its own first Challengers. Like 4-6-6-4s on the UP and the Western Maryland, the articulated Z-6s replaced older, slower rigid-frame engines — doubleheaded Mikados in the Northern Pacific's case. The Z-6s spent most of their careers hauling reefer trains and fast freights on Northern Pacific divisions in Washington State and Montana's Big Sky country, with occasional passenger stints leading the crack North Coast Limited. Sixty-nine inch drivers allowed a Z-6 to maintain 60 mph on the plateaus between the Northwest's mountain ranges.

The Northern Pacific was pleased enough with its new articulateds to order nine more Z-6s in 1937. The same year, an additional six engines were ordered for the Spokane, Portland & Seattle, a jointly-owned subsidiary of the NP and the Great Northern. The SP&S engines were oil burners, but virtually identical to the NP Z-6s in every other way. Two of the SP&S engines were later sold to the Great Northern for use in Washington and Oregon. For a time in the late steam era, the thundering Z-6 was indeed the Northwest's own articulated.



NEW TOOLING! Great Northern - 4-6-6-4 Z-6 Challenger Steam Engine w/Proto-Sound® 2.0
 20-3272-1 Hi-Rail Wheels \$1399.95
 20-3272-2 Scale Wheels \$1399.95



NEW TOOLING! Northern Pacific - 4-6-6-4 Z-6 Challenger Steam Engine w/Proto-Sound® 2.0
 20-3273-1 Hi-Rail Wheels \$1399.95
 20-3273-2 Scale Wheels \$1399.95



NEW TOOLING! Spokane Portland & Seattle - 4-6-6-4 Z-6 Challenger Steam Engine w/Proto-Sound® 2.0
 20-3274-1 Hi-Rail Wheels \$1399.95
 20-3274-2 Scale Wheels \$1399.95



NEW TOOLING! Great Northern - 4-6-6-4 Z-6 Challenger Steam Engine w/Proto-Sound® 2.0
 20-3278-1 Hi-Rail Wheels \$1399.95
 20-3278-2 Scale Wheels \$1399.95

Features

- Die-Cast Boiler, Cab, and Tender Body
- 1:48 Scale Proportions
- Die-Cast Metal Chassis
- Authentic Paint Scheme
- Metal Wheels and Axles
- Constant Voltage Headlight
- Die-Cast Truck Sides
- Precision® Flywheel Equipped Motor
- Proto-Scale 3-2 3-Rail/2-Rail Conversion Capable
- Locomotive Speed Control
- Remote Controlled Proto-Coupler™
- Engineer and Fireman Figures
- Operating Firebox Glow
- Metal Handrails and Decorative Bell
- Decorative Metal Whistle
- Operating Marker Lights
- Coal tender for NP version
- Oil tender for SP&S and GN versions
- Lighted Cab Interior
- Synchronized Puffing ProtoSmoke™
- Proto-Sound® 2.0 With The Digital Command System Featuring Freight Yard Proto-Effects™
- Unit Measures: 30 3/4" x 2 1/2" x 4"
- Hi-Rail Wheels Operate On O-72 Curves
- Scale Wheels Operate on 72" Radius Curves

4-6-6-4 M-2 Challenger Steam Engine



The Western Maryland's forte was moving heavy freight trains briskly through challenging territory. Railfans called it the Wild Mary and the road called itself the Fast Freight Line; both nicknames were appropriate. Using some of the nation's most modern steam power, the WM wrestled coal out of the Appalachian Mountains to its own tidewater terminal on the Chesapeake Bay. It also offered shippers the shortest route from the Great Lakes to the Atlantic seaboard. The road was known for keeping its motive power well maintained and freshly painted.

In 1940 and '41, just before the avalanche of wartime traffic descended on American railroads, the Western Maryland took delivery of 12 4-6-6-4 Challengers from Baldwin's Eddystone works. Alco had developed the first Challengers in 1936 as fast freight engines, and the Wild Mary's M-2 class engines were among the last and most modern of the breed. They were ordered to replace older 2-10-0 Decapods on the 171-mile route between Hagerstown, MD and Connellsville, PA. The M-2s had a top speed of 50 mph, and their increased speed and capacity allowed the WM to eliminate the engine change that the Decapods had required halfway through the route, resulting in lower operating costs for the railroad. According to Baldwin, a single M-2 could haul an 11,000-ton train up the Wild Mary's 1.75% ruling grade.



Southern - 4-6-6-4 M-2 Challenger Steam Engine

20-3244-1 Hi-Rail Wheels \$1399.95
20-3244-2 Scale Wheels \$1399.95



Western Maryland - 4-6-6-4 M-2 Challenger Steam Engine

20-3242-1 Hi-Rail Wheels \$1399.95
20-3242-2 Scale Wheels \$1399.95



Baltimore & Ohio - 4-6-6-4 M-2 Challenger Steam Engine

20-3243-1 Hi-Rail Wheels \$1399.95
20-3243-2 Scale Wheels \$1399.95



Western Maryland - 4-6-6-4 M-2 Challenger Steam Engine

20-3241-1 Hi-Rail Wheels \$1399.95
20-3241-2 Scale Wheels \$1399.95

Features

- Die-Cast Boiler and Tender Body
- 1:48 Scale Proportions
- Die-Cast Metal Chassis
- Authentic Paint Scheme
- Metal Wheels and Axles
- Constant Voltage Headlight
- Die-Cast Truck Sides
- Precision Pittman® Flywheel Equipped Motor
- Proto-Scale 3-2 3-Rail/2-Rail Conversion Capable
- Locomotive Speed Control
- Remote Controlled Proto-Coupler™
- Engineer and Fireman Figures
- Operating Firebox Glow
- Metal Handrails and Decorative Bell
- Decorative Metal Whistle
- Operating Marker Lights
- Lighted Cab Interior
- Synchronized Puffing ProtoSmoke™
- Scale Front Coupler w/Interchangeable O Gauge Coupler For Doubleheading
- Separately Applied Piping & Assorted Details
- Realistic & Authentic Builder's Plates
- Opening Cab Roof Hatch
- Sliding Cab Window Glass
- Opening Tender Water Hatches w/Proto-Sound® 2.0 Control Switches Inside
- Proto-Sound® 2.0 With The Digital Command System Featuring Freight Yard Proto-Effects™
- Unit Measures: 30 3/4" x 2 1/2" x 4"
- Hi-Rail Wheels Operate On O-72 Curves
- Scale Wheels Operate On 72" Radius Curves

ADD A MATCHING 2-BAY FISH BELLY HOPPER SET!

See Page 162

4-8-2 U1F Mountain Steam Engine Set



Canadian National took delivery of its first 4-8-2 locomotives in 1923, when they received the first sixteen of an ultimate fleet of 79 Mountains purchased over the next 20 years. Like the 4-8-2s on other railroads, CN's U1-class engines were designed for both passenger and freight service. The CN continued to order and operate 4-8-2s throughout its remaining steam years, demonstrating their confidence in the Mountains' power, speed, and reliability. M.T.H. models the CN's semi-streamlined U1F Mountain, which is distinguished by the conical smokebox front covers, which earned them the nickname "Bullet Nose Betties." Designed for fast passenger service and built by Montreal Locomotive Works in 1944 and early 1945, the 20 U1Fs were the last new steam power the railroad received. The last of the U1Fs was retired in 1962, the year after the Northerns had disappeared from the CN lines.

M.T.H. previously modeled CNR 6060, also known as the Spirit of Alberta, which is currently based in Stettler, Alberta, and used for summer railfan excursions. No. 6076 and matching passenger set arrives in 2007 as a beautifully detailed model sure to impress everyone who sees its smooth, powerful performance on your fast passenger and dual service road.

Did You Know?

The U1F was designed as a coal burner for Eastern service but many were later converted to oil firing for service in the West.



Canadian National - 4-8-2 U1F Mountain Steam Engine w/Proto-Sound® 2.0
20-3275-1 Hi-Rail Wheels \$1095.95



Features

- Die-Cast Boiler and Tender Body
- Die-Cast Metal Chassis
- Metal Wheels and Axles
- Authentic Paint Scheme
- Constant Voltage Headlight
- Die-Cast Truck Sides
- Precision Pittman® Flywheel Equipped Motor
- Remote Controlled Proto-Coupler™
- Engineer and Fireman Figures
- Operating Firebox Glow
- Metal Handrails and Decorative Bell
- Decorative Metal Whistle
- Operating Marker Lights
- Lighted Cab Interior
- Operating Tender Back-up Light
- Locomotive Speed Control
- Synchronized Puffing ProtoSmoke™
- Illuminated Number Boards
- Scale Front Coupler w/Interchangeable O Gauge Coupler For Doubleheading
- Separately Applied Piping & Assorted Details
- Realistic & Authentic Builder's Plates
- Opening Cab Roof Hatch
- Sliding Cab Window Glass
- Opening Tender Water Hatches w/Proto-Sound® 2.0 Control Switches Inside
- Proto-Sound® 2.0 With The Digital Command System Featuring Passenger Station Proto-Effects™
- Unit Measures: 23 1/2" x 2 5/8" x 3 3/4"
- Operates On O-54 Curves



Canadian National - U1f Steam Passenger Set
20-3276-1 Proto-Sound® 2.0 \$1199.95

4-8-4 Greenbrier Steam Engine Set



Sporting a markedly different appearance from previous steam motive power, C&O's J-3 4-8-4 Greenbrier first appeared in the 1930's ready to assume passenger service duties. Featuring a cleaner, more streamlined appearance than the F-19 Pacific it replaced, the Greenbrier utilized a USRA-designed cab that both Alco and Lima had employed for freight power. Each engine was decorated in white trim and gold lettering and featured the name of a distinguished Virginia statesman on each side of the sand box. The engine quickly established itself as a famous and significant name along the C&O right-of-way as it whisked famous and aristocratic passengers to the C&O's own resort hotel of the same name in White Sulphur Springs, West Virginia.

The unmistakable appearance of the Greenbrier returns to the Premier line for 2007. This beautiful steam engine, a must for any C&O fan, is equipped with the incredible sounds and features of the Proto-Sound® Digital Sound and Train Control System and features other enhancements O Gauge steam fans have come to expect from MTH, including ProtoSmoke™, a Pittman® flywheel-equipped motor, die-cast boiler and tender, die-cast chassis and truck sides, along with an operating headlight and cab interior lighting.

Imagine it's 1950 in the West Virginia mountains, and you're piloting one of the finest products of Lima Locomotive Works, the company that invented Super Power steam. Behind you stretches a string of varnish named the Fast Flying Virginian or the Sportsman. Can it get any better than this?



Chesapeake & Ohio - 4-8-4 Greenbrier Steam Engine w/Proto-Sound® 2.0
20-3277-1 Hi-Rail Wheels \$1099.95



Features

- Die-Cast Boiler and Tender Body
- Die-Cast Metal Chassis
- Metal Wheels and Axles
- Authentic Paint Scheme
- Constant Voltage Headlight
- Die-Cast Truck Sides
- Precision Pittman® Flywheel Equipped Motor
- Remote Controlled Proto-Coupler™
- Engineer and Fireman Figures
- Operating Firebox Glow
- Metal Handrails and Decorative Bell
- Decorative Metal Whistle
- Operating Marker Lights
- Lighted Cab Interior
- Operating Tender Back-up Light
- Locomotive Speed Control
- Proto-Scale 3-2™ 3-Rail/2-Rail Conversion Capable
- Synchronized Puffing ProtoSmoke™
- Illuminated Number Boards
- Scale Front Coupler w/Interchangeable O Gauge Coupler For Doubleheading
- Separately Applied Piping & Assorted Details
- Realistic & Authentic Builder's Plates
- Opening Cab Roof Hatch
- Sliding Cab Window Glass
- Opening Tender Water Hatches w/Proto-Sound® 2.0 Control Switches Inside
- Proto-Sound® 2.0 With The Digital Command System Featuring Passenger Station Proto-Effects™
- Unit Measures: 29" x 2 5/8" x 4"
- Operates On O-54 Curves



Chesapeake & Ohio - Greenbrier Steam Passenger Set
20-3260-1 Proto-Sound® 2.0 \$1199.95

GE U30C Diesel Engine



In 1953, Alco and General Electric went their separate ways, ending the partnership that had produced some of the handsomest first-generation diesel units, the FA and PA. Seven years later, GE was back in the market with the U25B, its first self-produced road locomotive and the product of an intensive research and development effort. By 1963, GE sales surpassed those of its former partner, and the company became a serious threat to EMD's market dominance. The nation's diesel builders were locked in a horsepower race as railroads bought second-generation power to replace the first-generation diesels that had killed the steam engine. In 1966, General Electric introduced the six-axle, 3000 hp U30C, aimed directly at EMD's equally powerful SD40.

While the U30C did not outsell the SD40, it became General Electric's best-selling "U-boat." It set the stage for GE to pull ahead of EMD in diesel sales by 1983, and stay ahead to this day. Over the course of a 10-year production run, nearly 600 U30Cs were sold to 17 class one railroads, while other roads such as Conrail acquired them in mergers. Union Pacific and Burlington Northern owned the largest fleets, with BN using its U30Cs to haul coal from the massive Powder River Basin deposits in Montana and Wyoming. Many U30Cs served nearly three decades before retirement in the early 1990s. New for 2007, GE's most popular Universal-series diesel joins the M.T.H. lineup, with all the features you expect in a Premier diesel: superb detailing; accurate paint schemes; bold, prototypical sounds; and smooth, steady operation at any speed from a crawl to full throttle.



NEW TOOLING!

Burlington Northern - GE U30C Diesel Engine w/Proto-Sound® 2.0

20-2778-1	Hi-Rail Wheels	\$429.95
20-2778-2	Scale Wheels	\$449.95
20-2778-3	Non-Powered	\$169.95



NEW TOOLING!

Norfolk Southern - GE U30C Diesel Engine w/Proto-Sound® 2.0

20-2779-1	Hi-Rail Wheels	\$429.95
20-2779-2	Scale Wheels	\$449.95
20-2779-3	Non-Powered	\$169.95



NEW TOOLING!

Reading - GE U30C Diesel Engine w/Proto-Sound® 2.0

20-2780-1	Hi-Rail Wheels	\$429.95
20-2780-2	Scale Wheels	\$449.95
20-2780-3	Non-Powered	\$169.95



PREMIER DIESEL 93

Features

- Intricately Detailed ABS Body
- Die-Cast Truck Sides, Pilots and Fuel Tank
- Colorful Paint Scheme
- Metal Chassis
- Metal Handrails and Decorative Horn
- (2) Cab Figures
- Metal Body Side Grilles
- Directionally Controlled Headlights
- Metal Wheels, Axles and Gears
- (2) Remotely Controlled Proto-Couplers™
- (2) Precision Flywheel Equipped Motors
- Locomotive Speed Control
- Lighted Cab Interior
- Illuminated Number Boards
- Lighted Marker Lights
- Operating Smoke Unit
- Proto-Scale 3-2™ 3-Rail/2-Rail Conversion Capable
- Proto-Sound® 2.0 With The Digital Command System Featuring Freight Yard Proto-Effects™
- Unit Measures: 17 1/2" x 2 1/2" x 4 5/16"
- Operates On O-42 Curves

ADD A LIGHT KIT TO YOUR NON-POWERED LOCOMOTIVE

Order Item Number 50-1026. Light Kits feature two pickup rollers and "always on" light assembly

NEW TOOLING!

Union Pacific - GE U30C Diesel Engine w/Proto-Sound® 2.0

20-2781-1	Hi-Rail Wheels	\$429.95
20-2781-2	Scale Wheels	\$449.95
20-2781-3	Non-Powered	\$169.95

GP-30 Diesel Engine



Called by Trains magazine "nothing less than a landmark unit in Electro-Motive's all-time production record," the GP-30 represented a major shift in EMD's locomotive design. The GP-30's departures from earlier Geeps (as the GP class was called) include the relocation of all the engine's radiators to the end of the unit and the centralization of the air distribution system used to cool the traction motors. It is also the only EMD locomotive to bear the distinctive cowled cab-top and streamlined features. The 2250 horsepower GP-30 was developed in direct response to General Electric's announcement of the 2500 horsepower U25B, which introduced the more efficient centralized air distribution system. Although the GP-30 had a lower horsepower rating than GE's U25B, EMD's marketers decided to break with their recent engine-naming practice and introduce the new Geep not as GP-22, which represented its horsepower, but as GP-30, to give it a larger, more powerful number than GE's competing diesel.

The GP-30 was introduced in July 1961. Twenty-seven railroads had bought 948 units by the time production stopped in November 1963. GP-30s were initially used for fast freight service, but as the more powerful GP-35s and GP-40s appeared, the -30s were changed to yard and branch line service. Many GP-30s remained in service for more than 30 years after they were built.



Great Northern - GP-30 Diesel Engine

20-2776-1	Proto-Sound® 2.0	\$399.95
20-2776-3	Non-Powered	\$159.95



Pennsylvania - GP-30 Diesel Engine

20-2749-1	Proto-Sound® 2.0	\$399.95
20-2749-3	Non-Powered	\$159.95



Rio Grande - GP-30 Diesel Engine

20-2748-1	Proto-Sound® 2.0	\$399.95
20-2748-3	Non-Powered	\$159.95



Santa Fe - GP-30 Diesel Engine

20-2777-1	Proto-Sound® 2.0	\$399.95
20-2777-3	Non-Powered	\$159.95



Wisconsin Central - GP-30 Diesel Engine

20-2751-1	Proto-Sound® 2.0	\$399.95
20-2751-3	Non-Powered	\$159.95



Baltimore Orioles™ - GP-30 Diesel Engine

20-2752-1	Proto-Sound® 2.0	\$399.95
20-2752-3	Non-Powered	\$159.95



Washington Redskins - GP-30 Diesel Engine

20-2753-1	Proto-Sound® 2.0	\$399.95
20-2753-3	Non-Powered	\$159.95

 Major League Baseball trademarks and copyrights are used with permission of Major League Baseball Properties, Inc. MLB.com MTH Trains/MLBP 2006

 ©2006, NFL Enterprises LLC. NFL and the NFL Shield design are registered trademarks of the National Football League. The team names, logos and uniform designs are registered trademarks of the teams indicated.

Features

- (2) Remotely Controlled Proto-Couplers™
- Metal Chassis
- (2) Precision Flywheel Equipped Motors
- Illuminated Number Boards
- Intricately Detailed ABS Body
- Directionally Controlled Headlights
- Die-Cast Truck Sides, Pilots and Fuel Tank
- Authentic Paint Scheme
- Metal Handrails and Decorative Horn
- Lighted Cab Interior
- Lighted Marker Lights
- (2) Engineer Cab Figures
- Spinning Roof Fans
- Metal Body Side Grilles
- Operating Smoke Unit
- Metal Wheels, Axles and Gears
- Locomotive Speed Control
- Proto-Scale 3-2™ 3-Rail/2-Rail Conversion Capable
- Proto-Sound® 2.0 With The Digital Command System Featuring Freight Yard Proto-Effects™
- Unit Measures: 15" x 2 3/4" x 4 1/4"
- Operates On O-31 Curves

ADD A LIGHT KIT TO YOUR NON-POWERED LOCOMOTIVE

Order Item Number 50-1025. Light Kits feature two pickup rollers and "always on" light assembly

GP-40 Diesel Engine

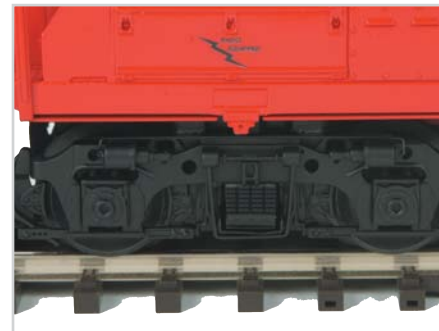

Features

- Directionally Controlled Headlights
- Intricately Detailed ABS Body
- Metal Wheels, Axles and Gears
- Die-Cast Truck Sides, Pilots and Fuel Tank
- (2) Remotely Controlled Proto-Couplers™
- Colorful Paint Scheme
- Metal Chassis
- Metal Handrails and Decorative Horn
- (2) Precision Flywheel Equipped Motors
- Locomotive Speed Control
- Proto-Scale 3-2™ 3-Rail/2-Rail Conversion Capable
- Lighted Cab Interior
- Illuminated Number Boards
- Lighted Marker Lights
- (2) Engineer Cab Figures
- Spinning Roof Fans
- Metal Body Side Grilles
- Operating Smoke Unit
- Proto-Sound® 2.0 With The Digital Command System Featuring Freight Yard Proto-Effects™
- Unit Measures: 15 1/2" x 2 3/4" x 4"
- Operates On O-31 Curves

ADD A LIGHT KIT TO YOUR NON-POWERED LOCOMOTIVE

Order Item Number 50-1025. Light Kits Feature two pickup rollers and "always on" light assembly

CONVERT YOUR POWER TRUCKS TO SCALE WHEELS

Order Item Number 20-89005 4-Wheel Truck Scale Wheel Set*

*Requires 2

By the mid-1960s, EMD's General Purpose locomotives, known as "Geeps," had gained a favorable reputation with railroads. They were hard working road switchers known for their versatility and dependability. The 1500-h.p. GP-7, introduced in 1949, had set the standard for the series of locomotives, and the GP-40, which came along 16 years later, was to be yet another improvement in the GP family tree.

The GP-40 doubled the horsepower rating of the GP-7 and introduced the 645-series engine to the Geep heritage. EMD had relied upon the 567-series prime mover for years. The 3,000-h.p. in the GP-40 was indeed impressive, but it presented a problem. With only four axles and the barely adequate wheel-slip control systems then available, GP-40s had adhesion problems. While the units were being fixed at the La Grange, IL, plant, EMD supplied GP-40 buyers with temporary units. An improved electrical system fixed the adhesion problem on the GP-40s and they were ready to roll on U.S., Canadian and Mexican railroads once again.

By choosing one of the finest diesel road engines available today, your M.T.H. GP-40 engine will arrive with features unmatched by others. The incredible sound and action found in a Proto-Sound® 2.0 equipped M.T.H. engine truly brings an interactive experience to your locomotive operations. Realistic, slow-speed operation is controlled through the industry-leading Proto-Speed Control™ system. Remotely controlled Proto-Couplers™ which can be fired open at any time in conventional or command modes gives the operator unprecedented switching functions for a truly fun operating experience.

Did You Know?

EMD overcame early adhesion problems and sold 2,398 of the popular GP-40 units.

Western Maryland - GP-40 Diesel Engine

20-2758-1	Proto-Sound® 2.0	\$399.95
20-2758-3	Non-Powered	\$159.95



Missouri Kansas & Texas Railway GP-40 Diesel Engine

20-2756-1	Proto-Sound® 2.0	\$399.95
20-2756-3	Non-Powered	\$159.95

Richmond, Fredericksburg & Potomac GP-40 Diesel Engine

20-2757-1	Proto-Sound® 2.0	\$399.95
20-2757-3	Non-Powered	\$159.95



Canadian National GP-40 Diesel Engine

20-2754-1	Proto-Sound® 2.0	\$399.95
20-2754-3	Non-Powered	\$159.95

GP-40 Chessie "Show Train" Set



One by one, America's railroads, in the face of lessening demand for their services, faced tough decisions throughout the 20th century that would effect their very survival. One of the most common approaches to the weakened demand was to consolidate or merge two or more roads into one more powerful entity. Often, the larger of the railroads in these mergers would retain its name and herald and the smaller roads would cease to exist.

In 1972, the new president of the merged Chesapeake & Ohio and Baltimore & Ohio railroads, Hays T. Watkins, elected to fold both nameplates into an entirely new railroad he dubbed the Chessie System. To help promote the "new" railroad, Watkins and his marketing team developed an entirely new bold look that included a new corporate logo and bright orange, yellow and blue colors to adorn both motive power and rolling stock.

To help promote the new look, Chessie sent out a "Show Train" in September of 1972 to tour the country and visit as many potential shippers and customers as possible. By year's end, the special train has travelled over 3,500 miles and "visited" over 5,000 customers.

Outfitted with five freight cars, the Show Train was powered by two EMD GP-40 diesels, each uniquely decorated. The lead locomotive was trimmed in gold paint and sported EMD's 50th anniversary logos while the trailing unit featured Chessie's new Cat logo and orange, yellow and blue livery. The train's consist was made up of a box car, gondola, open and closed hopper cars as well as a caboose and each of these cars sported a combination of the new colors and logos.

Join M.T.H. in celebrating the 35th anniversary of the Chessie System with this unique set containing the gold GP-40 and five trailing freight cars from the M.T.H. Premier Line. Like our regular GP-40 locomotives, the Chessie Show Train's engine includes all our standard locomotive features and each of our freight cars ride atop the industry's smoothest rolling freight trucks.



Features

Set Features

- GP-40 Diesel Locomotive
- 5-Car Freight Car Consist

Locomotive Features

- Directionally Controlled Headlights
- Metal Wheels, Axles and Gears
- Die-Cast Truck Sides, Pilots and Fuel Tank
- (2) Remotely Controlled Proto-Couplers™
- Colorful Paint Scheme
- Metal Chassis
- Metal Handrails and Decorative Horn
- Proto-Scale 3-2™ 3 Rail/2-Rail Conversion Capable

Freight Car Features

- Illuminated Number Boards
- Lighted Marker Lights
- Metal Body Side Grilles
- Spinning Roof Fans
- (2) Precision Flywheel Equipped Motors
- (2) Cab Figures
- Lighted Cab Interior
- Operating Smoke Units
- Locomotive Speed Control
- Intricately Detailed ABS Body
- Proto-Sound® 2.0 With The Digital Command System Featuring Freight Yard Proto-Effects™
- Unit Measures: 15 1/2" x 2 3/4" x 4"
- Operates On O-31 Curves

Chessie - GP-40 Chessie Show Train Set

20-2782-1 Proto-Sound® 2.0 \$499.95



FT A-B-A Diesel Engine Set



Features

- Directionally Controlled Headlights
- Intricately Detailed ABS Bodies
- Metal Wheels, Axles and Gears
- Die-Cast Truck Sides, Pilots and Fuel Tank
- (2) Remotely Controlled Proto-Couplers™
- Authentic Paint Scheme
- Metal Chassis
- Metal Handrails and Decorative Horn
- (2) Precision Flywheel Equipped Motors In Each A Unit
- Locomotive Speed Control
- Lighted Cab Interiors
- Illuminated Number Boards
- Lighted Marker Lights
- (2) Engineer Cab Figures In Each A Unit
- Spinning Roof Fans
- Metal Body Side Grilles
- (2) Operating Smoke Units
- Proto-Sound® 2.0 With The Digital Command System Featuring Freight Yard Proto-Effects™
- Set Measures: 38 1/4" x 2 5/8" x 3 3/4"
- Operates On O-31 Curves

Did You Know?

The original FT demonstrator was sold to the Southern Railway and soldiered on for 20 more years. The lead unit, Southern #6100, is today a National Historic Mechanical Engineering Landmark, preserved at the National Museum of Transport in St. Louis.

The EMD-built FT freight diesel was born in November 1939 in the La Grange, IL, General Motors plant. Number 103, the four-unit FT demonstrator, didn't take any baby steps. It immediately started an 11-month, 35-state tour, logging 83,764 miles on 20 Class I railroads. Wherever it went, the FT beat the railroads' best steam engines at every task. By the end of the tour, steam was, for all practical purposes, dead. As famed Trains magazine editor David P. Morgan later put, the FT was "the diesel that did it."

The FT demonstrator was made up of four units, each with a 16-cylinder engine that hammered out 1350 horsepower. The demonstrator's combined rating of 5400 hp was similar to that of many "superpower" steam engines, but the FT made far more efficient use of its power. The A units at either end were 48'3" long and the cabbles B units were 48'1" in length. Initially, EMD built FTs in semi-permanently coupled A-B pairs, but the A-B-A arrangement was an alternative.

Redesigned Blomberg trucks on the FT include separately-applied truck springs, air brake cylinders, air lines, and speed recorder cable. Modular molds enable models to have the correct roof fans, horns, grab irons, and headlight and number board placement for each individual road name. End and pilot details include added-on hoses. Paint colors are accurately researched. We think you'll agree that our upgraded F-units set a new standard of detail and accuracy for 3-rail carbody diesels.

Chicago NorthWestern - FT A-B-A Diesel Set

20-2744-1	Proto-Sound® 2.0	\$699.95
20-2744-3	Non-Powered B-Unit	\$159.95



Milwaukee Road - FT A-B-A Diesel Set

20-2746-1	Proto-Sound® 2.0	\$699.95
20-2746-3	Non-Powered B-Unit	\$159.95



Western Pacific - FT A-B-A Diesel Set

20-2747-1	Proto-Sound® 2.0	\$699.95
20-2747-3	Non-Powered B-Unit	\$159.95



Lehigh Valley - FT A-B-A Diesel Set

20-2745-1	Proto-Sound® 2.0	\$699.95
20-2745-3	Non-Powered B-Unit	\$159.95

C-Liner A-B-A Diesel Engine Set



Features

- (2) Remotely Controlled Proto-Couplers™
- Metal Chassis
- Illuminated Number Boards
- Directionally Controlled Headlights
- Die-Cast Truck Sides, Pilots and Fuel Tank
- Authentic Paint Scheme
- Metal Handrails and Decorative Horn
- Lighted Marker Lights
- Spinning Roof Fans
- Metal Body Side Grilles
- Intricately Detailed ABS Bodies
- Metal Wheels, Axles and Gears
- (2) Precision Flywheel Equipped Motors In Each A Unit
- Lighted Cab Interiors
- (2) Engineer Cab Figures In Each A Unit
- (2) Operating Smoke Units
- Proto-Sound® 2.0 With The Digital Command System Featuring Freight Yard Proto-Effects™
- Unit Measures: 48 1/2" x 2 5/8" x 3 3/4"
- Operates On O-42 Curves

Did You Know?

Fairbanks-Morse offered the C-Liner in six different horsepower-wheel arrangement combinations, all but one of which were eventually made.

The Fairbanks-Morse Consolidation Line engines - fondly known as C-Liners - were an enormously versatile class of cab units. Railroads had a choice of three engines, 1600, 2000, or 2400 hp, and nine gear ratios. Dynamic braking and steam generators were options at the factory or could be added later. These adaptable engines could be configured to perform just about any job, and they performed well in both freight and passenger service.

M.T.H. is proud to introduce this all-purpose engine in our Premier line, in a variety of roadnames. This powerful and detailed engine can perform just about any task your railroad can present.

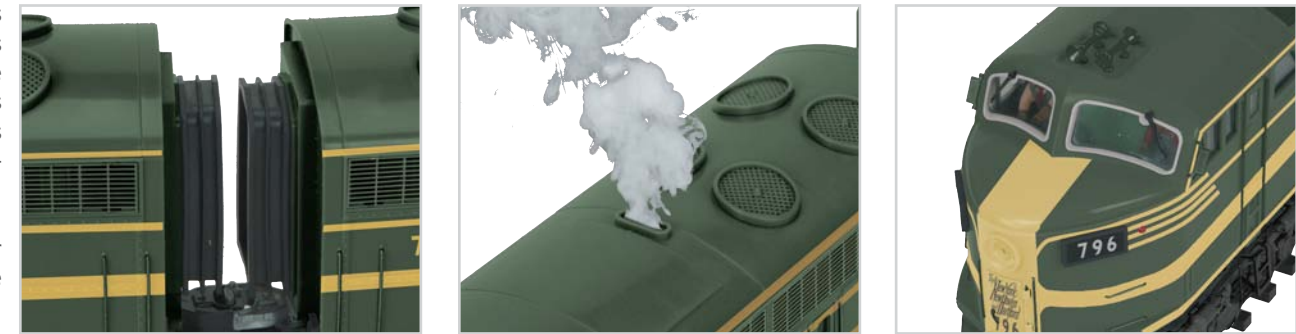

Canadian National - C-Liner ABA Diesel Engine Set
20-2731-1 Proto-Sound® 2.0 \$699.95



Long Island - C-Liner ABA Diesel Engine Set
20-2732-1 Proto-Sound® 2.0 \$699.95



New York Central - C-Liner ABA Diesel Engine Set
20-2734-1 Proto-Sound® 2.0 \$699.95



New Haven - C-Liner ABA Diesel Engine Set
20-2733-1 Proto-Sound® 2.0 \$699.95

Dash-8 40C Narrow Nose Diesel Engine



In the late 1980s, as General Electric and General Motors' Electro-Motive Division engaged in heated competition (that continues today) for market share in the high horsepower category, GE announced its Dash 8 line of diesel locomotives. Although the first demonstrator version had only 3,200 hp, most of the Dash-8s had 4,000 hp when delivered and were therefore designated Dash 8-40. Because GE builds its diesel locomotives in five modules, it was able to customize its Dash 8s for each buyer to an unusual degree. Some railroads ordered their Dash 8s with conventional cabs, while others opted for the wider North American or comfort cabs, identified by a "W" in the engine name. Some Dash 8s have 4-wheel trucks — denoted with a "B" — while a Dash 8-40C has 6-wheel trucks. This variety meant that these diesels, which were designed for fast freight duty, also found a home in Amtrak passenger service. Despite their many differences, all Dash 8s share microprocessor control. The microprocessor, a small computer, regulates rpm, fuel injection volume, generator excitation, and many other operational features to make the Dash 8s run more efficiently than any diesels before them.

M.T.H. is proud to introduce a superbly detailed replica of the Dash 8 model that found its niche in high-speed intermodal service, the Dash 8-40C — 4000 horsepower, 6-wheel trucks, standard cab. Like its prototype, this model is a perfect choice to power the hottest trains on your railroad.

Did You Know?

The microprocessor in the prototype Dash 8 recognizes if its 16-cylinder engine is overheating in a tunnel, as opposed to a malfunction on the open rails, and allows it to keep operating at full power for ten minutes so the crew doesn't find itself stranded in a tunnel.



CSX - Dash-8 40C Narrow Nose Diesel Engine

20-2642-1	Hi-Rail Wheels	\$429.95
20-2642-2	Scale Wheels	\$449.95
20-2642-3	Non-Powered	\$169.95



Union Pacific - Dash-8 40C Narrow Nose Diesel Engine

20-2643-1	Hi-Rail Wheels	\$429.95
20-2643-2	Scale Wheels	\$449.95
20-2643-3	Non-Powered	\$169.95



Norfolk Southern - Dash-8 40C Narrow Nose Diesel Engine

20-2644-1	Hi-Rail Wheels	\$429.95
20-2644-2	Scale Wheels	\$449.95
20-2644-3	Non-Powered	\$169.95



Chicago NorthWestern
Dash-8 40C Narrow Nose Diesel Engine

20-2641-1	Hi-Rail Wheels	\$429.95
20-2641-2	Scale Wheels	\$449.95
20-2641-3	Non-Powered	\$169.95

Features

- Die-Cast Truck Sides, Pilots and Fuel Tank
- Intricately Detailed ABS Body
- Authentic Paint Scheme
- Metal Body Side Grilles
- Spinning Roof Fans
- Metal Chassis
- Metal Handrails and Decorative Horn
- Directionally Controlled Headlights
- Metal Wheels, Axles and Gears
- (2) Remotely Controlled Proto-Couplers™
- (2) Precision Flywheel Equipped Motors
- Lighted Cab Interior
- Illuminated Number Boards
- Operating Smoke Unit
- (2) Engineer Cab Figures
- Locomotive Speed Control
- Proto-Scale 3-2™ 3-Rail/2-Rail Conversion Capable
- Proto-Sound® 2.0 With The Digital Command System Featuring Freight Yard Proto-Effects™
- Unit Measures: 17 3/4" x 2 1/2" x 4"
- Operates On O-42 Curves

ADD A LIGHT KIT TO YOUR NON-POWERED LOCOMOTIVE

Order Item Number 50-1026. Light Kits Feature two pickup rollers and "always on" light assembly

F-7 A-B-A Diesel Engine Set



The F7 was the zenith of the “covered wagon,” or carbody-style diesel. With 3,849 units built between 1949 and 1953, the F7 was both the most popular carbody diesel and its last hurrah. By 1954 U.S. railroads had virtually stopped ordering F-units in favor of hood units like EMD’s GP9 and Alco’s RS-3. The side walkways of hood units offered better access for maintenance and better visibility for backup moves, making them truly universal locomotives useful for both mainline runs and road switching.

Externally, the F7 was very similar to the earlier F3. The key spotting features that distinguished an F7 were its stainless

steel upper body grilles that replaced the “chicken wire” worn by most F3s, and the rooftop dynamic brake fan that replaced the F3’s rectangular roof vents just behind the cab. Internally, the F7 was also an evolution of the F3. While horsepower was the same, new D27 traction motors allowed the F7 to handle a heavier load.

Relive the sights, sounds, and drama of postwar railroading with this four-motored, full-scale model. Throttle down to speeds as low as 3 scale miles per hour with any load, or roll along at the prototype’s maximum speed of 102 mph with passenger gearing. Proto-Sound® 2.0 offers authentic EMD

567 prime mover sounds, a first-generation diesel horn and bell, crew and station sounds, and adjustable smoke volume. The F7 features the same level of superb detailing that characterizes all Premier F-units, with added-on details that include legible builder’s plates, grab irons, multiple-unit hoses, rooftop lift rings, see-through rooftop fans, steam generator exhaust stack (for passenger versions), windshield wipers, and trucks with separately-applied spring hangers, brake cylinders, and air pipes.

Canadian National - F-7 ABA Diesel Set

20-2739-1	Proto-Sound® 2.0	\$699.95
20-2739-3	Non-Powered B-Unit	\$159.95



Chesapeake & Ohio - F-7 ABA Diesel Set

20-2741-1	Proto-Sound® 2.0	\$699.95
20-2741-3	Non-Powered B-Unit	\$159.95



Reading - F-7 ABA Diesel Set

20-2743-1	Proto-Sound® 2.0	\$699.95
20-2743-3	Non-Powered B-Unit	\$159.95



Potomac Eagle - F-7 ABA Diesel Set

20-2742-1	Proto-Sound® 2.0	\$699.95
20-2742-3	Non-Powered B-Unit	\$159.95

Features

- Directionally Controlled Headlights
- Die-Cast Truck Sides, Pilots and Fuel Tank
- (2) Remotely Controlled Proto-Couplers™
- Metal Chassis
- Metal Handrails and Decorative Horn
- (2) Precision Flywheel Equipped Motors
- Lighted Cab Interior
- Illuminated Number Boards
- Lighted Marker Lights
- (2) Engineer Cab Figures
- Operating Smoke Unit
- Metal Body Side Grilles
- Intricately Detailed ABS Body
- Metal Wheels, Axles and Gears
- Locomotive Speed Control
- Proto-Sound® 2.0 With The Digital Command System Featuring Freight Yard or Passenger Station Proto-Effects™
- Set Measures: 40 1/4" x 2 5/8" x 3 3/4"
- Operates On O-31 Curves

Did You Know?

Beginning in 1949, 3716 F-7 units were produced for 49 U.S. and Canadian railroads.

E-6 Diesel Engine Set



ONLY \$23.25
CHICAGO - MIAMI
 \$20.15 St. Louis-Miami
 (Reduction on round trip fares)
 Proportionately low fares
 from other points

For Florida-bound Chicagoans in the winter of 1940, the City of Miami was the first taste of the tropical vacation that lay ahead. On the cold and grey station platform, the City shone like a bird of paradise. The palm green bow wave on its single, new E6 diesel was followed by seven yellow-orange, green, and scarlet passenger cars, each named for a tropical plant: Bougainvillea, Camellia, Japonica, and more, ending with Tavern-Lounge-Observation Bamboo Grove, whose bar sported a natural bamboo canopy. The Illinois Central's brochure proclaimed its Luxury Coach Diesel Streamliner to be "Superb in Beauty... Supreme in Comfort." Aboard were a stewardess and a registered nurse, as well as a "special coach reserved for the exclusive use of women and children." Dinner in the diner Palm Garden cost 60¢. At night the coaches featured "dimmed lights, no noise" so one could sleep in the "deep, soft reclining seats adjustable to your individual needs." The City left Chicago at 9:40AM, stopped in Jacksonville exactly 24 hours later, and arrived in Miami by late afternoon.

The City was actually part of a cooperative effort by nine railroads against a common enemy: the automobile. The Pennsy's South Wind and the Florida East Coast's Dixie Flagler - both steam-powered - and the Illinois Central's City of Miami each departed every third day on the 29½-hour Chicago-Miami route. Although the City's tropical paint scheme would only last until just after World War II, the train would remain on the timetable until the birth of Amtrak in 1971.

Add a splash of Florida sunshine to your layout with this new, authentic model of one of the earliest diesel streamliners. With the two-car add-on set, you can recreate the City's complete seven-car consist. For 2007 we also offer the E6 in three additional Premier A-B-A sets. Information on the prototype E6 and features of each 2007 model can be found by searching on the item number on www.mthtrains.com.



Atlantic Coast Line - E-6 ABA Diesel Engine Set
 20-2735-1 Proto-Sound® 2.0 \$699.95
 20-2735-3 Non-Powered B-Unit \$159.95



Missouri & Pacific - E-6 ABA Diesel Engine Set
 20-2737-1 Proto-Sound® 2.0 \$699.95
 20-2737-3 Non-Powered B-Unit \$159.95



Southern - E-6 ABA Diesel Engine Set
 20-2738-1 Proto-Sound® 2.0 \$699.95
 20-2738-3 Non-Powered B-Unit \$159.95



Features

- (2) Remotely Controlled Proto-Couplers™
- Metal Body Side Grilles
- Metal Chassis
- Metal Wheels, Axles and Gears
- Illuminated Number Boards
- Directionally Controlled Headlights
- Die-Cast Truck Sides, Pilots and Fuel Tank
- Authentic Paint Scheme
- Metal Handrails and Decorative Horn
- Lighted Marker Lights
- (2) Precision Flywheel Equipped Motors In Each A Unit
- Lighted Cab Interiors
- (2) Operating Smoke Units
- Locomotive Speed Control
- (2) Cab Figures In Each A Unit
- Proto-Sound® 2.0 With The Digital Command System Featuring
- Passenger Station Proto-Effects™
- Set Measures: 53" x 2 1/2" x 3 1/2"
- Operates On O-42 Curves



Illinois Central - E-6 City of Miami Diesel Passenger Set
 20-2736-1 Proto-Sound® 2.0 \$699.95

SD24 Diesel Engine



In 1958, GM's Electro-Motive Division took a great technological stride forward with the introduction of the turbocharged SD24. In turbocharged engines, exhaust gases are used to power a turbine that increases cylinder air pressure, thus effectively increasing horsepower. In fact, the 16-cylinder model 567 diesel that produced 1800 horsepower in the normally aspirated SD18 locomotive was upgraded to 2400 horsepower in the turbocharged SD24.

Turbocharged engines also run better at varying altitudes, making them ideal for railroads that travel through changing terrain. Look on the left side of the SD24's hood for the semi-circular bulge that marks the location of the turbine.

The SD24s were close relatives of the popular GP-series engines. The primary difference was that SD-series (for "Special Duty") locomotives were lengthened to make room for three-axle, three-motor trucks. For a GP and an SD engine of the same horsepower, the extra wheels on an SD locomotive gave it more tractive effort at low speeds and less engine weight on each axle. For this reason, the SD24 and others in the SD series were ideally suited for secondary lines with lighter rail.

Last cataloged in 2004, the SD24 returns to the Premier product line in 2007 in four exciting paint schemes each outfitted with the power and performance of Proto-Sound® 2.0.



Burlington Northern - SD24 Diesel Engine
 20-2759-1 Proto-Sound® 2.0 \$399.95
 20-2759-3 Non-Powered \$159.95



Southern - SD24 Diesel Engine
 20-2761-1 Proto-Sound® 2.0 \$399.95
 20-2761-3 Non-Powered \$159.95



Union Pacific - SD24 Diesel Engine
 20-2762-1 Proto-Sound® 2.0 \$399.95
 20-2762-3 Non-Powered \$159.95



Chicago NorthWestern - SD24 Diesel Engine
 20-2760-1 Proto-Sound® 2.0 \$399.95
 20-2760-3 Non-Powered \$159.95

Features

- (2) Remotely Controlled Proto-Couplers™
- Metal Chassis
- (2) Precision Flywheel Equipped Motors
- Illuminated Number Boards
- Intricately Detailed ABS Body
- Directionally Controlled Headlights
- Die-Cast Truck Sides, Pilots and Fuel Tank
- Authentic Paint Scheme
- Metal Handrails and Decorative Horn
- Lighted Cab Interior
- Lighted Marker Lights
- Spinning Roof Fans
- Metal Body Side Grilles
- Operating Smoke Unit
- Metal Wheels, Axles and Gears
- Locomotive Speed Control
- (2) Cab Figures
- Proto-Sound® 2.0 With The Digital Command System Featuring Freight Yard Proto-Effects™
- Unit Measures: 15 3/8" x 2 5/8" x 4"
- Operates On O-31 Curves

ADD A LIGHT KIT TO YOUR NON-POWERED LOCOMOTIVE

Order Item Number 50-1026. Light Kits Feature two pickup rollers and "always on" light assembly

SD60M Diesel Engine



Introduced in the mid-1980s, the SD60 and its four-axle sister, the GP60, were the first EMD diesels to incorporate computer technology and onboard diagnostics to aid the engineer. Under the hood was a 16-cylinder model 710 prime mover rated at 3800 horsepower. In January 1989, the Union Pacific Railroad accepted the initial order of SD60M's, featuring GM's version of the North American Safety Cab. The wide-nosed cab was relatively new to American rails but had been popular for some years with Canadian crews, who found it particularly cozy in the winter.

The Safety Cab underwent several changes in appearance over the years, with the transition from a three-piece windshield to a two-piece model one of the most obvious. Other upgrades included the addition of front number boards above the windshield and window glass in the nose-mounted cab access door.

The SD60M returns to the MTH lineup in 2007 in four paint schemes, each loaded with the added-on details and operating features that make M.T.H. Premier Line diesels a terrific value.

Did You Know?

EMD's SD50 diesel, introduced in 1980, had engine problems that led to the introduction of the SD60 just four years later. The SD50's model 645 prime mover was working so close to its limitations that the motor required a major overhaul every two years - twice as often as the motor in the previous SD-40 and SD40-2 locomotives. Responding to customer complaints, EMD developed the stronger, more reliable model 710 prime mover introduced in the SD60 diesel.



Conrail - SD60M Diesel Engine

20-2763-1	Proto-Sound® 2.0	\$429.95
20-2763-3	Non-Powered	\$169.95



CSX - SD60M Diesel Engine

20-2764-1	Proto-Sound® 2.0	\$429.95
20-2764-3	Non-Powered	\$169.95



Norfolk Southern - SD60M Diesel Engine

20-2765-1	Proto-Sound® 2.0	\$429.95
20-2765-3	Non-Powered	\$169.95



Union Pacific - SD60M Diesel Engine

20-2766-1	Proto-Sound® 2.0	\$429.95
20-2766-3	Non-Powered	\$169.95

Features

- (2) Remotely Controlled Proto-Couplers™
- Metal Chassis
- (2) Precision Flywheel Equipped Motors
- Intricately Detailed ABS Body
- Spinning Roof Fans
- Metal Body Side Grilles
- Operating Smoke Unit
- Die-Cast Truck Sides
- Colorful Paint Scheme
- Metal Wheels, Axles and Gears
- Metal Handrails and Decorative Horn
- Lighted Cab Interior
- Illuminated Number Boards
- Lighted Marker Lights
- Operating Ditch Lights
- Locomotive Speed Control
- (2) Cab Figures
- Proto-Scale 3-2™ 3-Rail/2-Rail Conversion Capable
- Proto-Sound® 2.0 With The Digital Command System Featuring Freight Yard Proto-Effects™
- Unit Measures: 18 3/8" x 2 1/2" x 3 15/16"
- Operates On O-42 Curves

ADD A LIGHT KIT TO YOUR NON-POWERED LOCOMOTIVE

Order Item Number 50-1026. Light Kits Feature two pickup rollers and "always on" light assembly

CONVERT YOUR POWER TRUCKS TO SCALE WHEELS

Order Item Number 20-89006 6-Wheel Truck Scale Wheel Set*

*Requires 2

SD70ACe Diesel Twin-Stack Freight Set

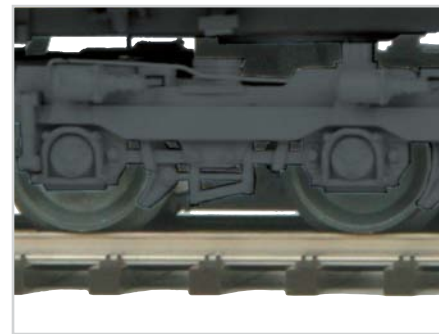

The SD70ACe is Electro-Motive Division's hope for the future. While designed to meet the Environmental Protection Agency's Tier-2 emissions requirements that took effect on January 1, 2005, this replacement for the SD70MAC also seems to have a higher purpose: to recapture the lead in North American locomotive sales that EMD lost to General Electric in 1987.

Under the hood beats a third-generation model 710 diesel with 4300 horsepower; only slight modifications were needed to make the model 710 meet new emission standards. With 5000 such motors in service worldwide and a reputation for dependability, EMD reasoned that shop crews would prefer familiar technology.

Other than the prime mover, however, virtually every element of the SD70ACe has been re-thought to create a 21st

century locomotive. Ergonomics were a prime consideration. The engine's angular nose offers the crew far better visibility than most other locomotives, and the cab is comfortable for engineers of almost any size. Digital screens provide a range of information on what is happening both inside the locomotive and out on the road. The cab easily accommodates a crew of three - an important factor in a modern world without cabooses. And there is, of course, a cupholder for the engineer.

The SD70ACe also offers, in EMD's words, "outstanding improvements in maintainability." All electrical wires are on the right side of the locomotive and all piping is on the left, with most pipes and wires routed under the frame so they can be serviced by a man standing outside the engine - rather than crawling around at the bottom of the engine room. The number of electrical components has been drastically reduced while

access to the remaining parts has been seriously improved. And the time between service intervals has been doubled, from every three months to every six months.

After a year of testing on the road and at the Association of American Railroads' test track in Pueblo, CO, the first SD70ACe's ('e' stands for "enhanced") were delivered to CSX Transportation in 2004. At the present time, mainline American railroads generally maintain dual fleets of locomotives. AC power is used for heavy coal hauling and hotshot intermodal traffic because AC traction motors offer higher starting tractive effort with the same horsepower. Less expensive, traditional DC power is used for more mundane duties. But with the SD70ACe, Electro-Motive hopes it may have the 21st Century successor to its 1949 Geep - a locomotive that can be nearly all things to all railroads.

Features

Set Features

- SD70ACe Diesel Engine with Proto-Sound® 2.0
- 5-Car Twin Stack Container Set

Locomotive Features

- Intricately Detailed ABS Body
- Die-Cast Truck Sides, Pilots and Fuel Tank
- Colorful Paint Scheme
- Metal Chassis
- Metal Handrails and Decorative Horn

- (2) Cab Figures
- Spinning Roof Fans
- Metal Body Side Grilles
- Directionally Controlled Headlights
- Metal Wheels, Axles and Gears
- (2) Remotely Controlled Proto-Couplers™
- (2) Precision Flywheel Equipped Motors
- Locomotive Speed Control
- Lighted Cab Interior
- Illuminated Number Boards

- Lighted Marker Lights
- Operating Ditch Lights
- Operating Smoke Unit
- Proto-Scale 3-2™ 3-Rail/2-Rail Conversion Capable
- Operates On O-42 Curves
- Measures: 18 1/2" x 2 5/8" x 4"

Twin Stack Car Features

- Intricately Detailed Durable ABS Body
- Metal Wheels and Axles
- Die-Cast 4-Wheel Trucks

- Operating Die-Cast Metal Couplers
- Colorful, Attractive Paint Schemes
- Decorative Brake Wheels
- Separate Metal Handrails
- Fast-Angle Wheel Sets
- Needle-Point Axles
- 1:48 Scale Dimensions
- Each End Car Measures: 14 3/4" x 2 3/4" x 3"
- Each Middle Car Measures: 13 5/16" x 2 3/4" x 3"
- Operates On O-42 Curves



BNSF - SD70ACe Diesel Twin-Stack Freight Set
20-2786-1 Proto-Sound® 2.0 \$699.95



CSX - SD70ACe Diesel Twin-Stack Freight Set
20-2785-1 Proto-Sound® 2.0 \$699.95

SD70ACe Diesel Engine Heritage Sets



Celebrate the Union Pacific Railroad's history with this unique collection of Heritage Sets based on the real life deco schemes created by the railroad giant over the past few years. A total of seven exciting schemes, each consisting of an O scale hi-rail SD70ACe, Hi-Cube Box Car and Extended Vision caboose, will be produced in U.P.'s heritage livery designs. The schemes will include Union Pacific, Denver & Rio Grande, Western Pacific, Chicago & North Western, Southern Pacific, MKT and Missouri Pacific railroads.



Union Pacific - 6-Car 50' High Cube Box Car Set
20-90359 \$249.95

continued on page 119



Union Pacific - SD70ACe Diesel Heritage Set

20-2774-1 Hi-Rail Wheels \$499.95

Union Pacific - SD70ACe Diesel Locomotive w/ Proto-Sound® 2.0

20-2774-2 Scale Wheels \$449.95



Southern Pacific - 6-Car 50' High Cube Box Car Set

20-90358 \$249.95



Southern Pacific - SD70ACe Diesel Heritage Set

20-2773-1 Hi-Rail Wheels \$499.95

Southern Pacific - SD70ACe Diesel Locomotive w/ Proto-Sound® 2.0

20-2773-2 Scale Wheels \$449.95

Features

Set Features

- SD70ACe Diesel Engine w/Proto-Sound® 2.0
- 50' Hi-Cube Box Car
- Extended Vision Caboose

Locomotive Features

- Intricately Detailed ABS Body
- Die-Cast Truck Sides, Pilots and Fuel Tank
- Colorful Paint Scheme
- Metal Chassis

- Metal Handrails and Decorative Horn
- (2) Cab Figures
- Spinning Roof Fans
- Metal Body Side Grilles
- Directionally Controlled Headlights
- Metal Wheels, Axles and Gears
- (2) Remotely Controlled Proto-Couplers™
- (2) Precision Flywheel Equipped Motors
- Locomotive Speed Control
- Lighted Cab Interior

- Illuminated Number Boards
- Lighted Marker Lights
- Operating Ditch Lights
- Operating Smoke Unit
- Proto-Scale 3-2™ 3-Rail/2-Rail Conversion Capable
- Operates On O-42 Curves
- Measures: 18 1/2" x 2 5/8" x 4"

Box Car Features

- Intricately Detailed Durable ABS Body
- Metal Wheels and Axles

- Die-Cast 4-Wheel Trucks
- Operating Die-Cast Metal Couplers
- Colorful, Attractive Paint Schemes
- Decorative Brake Wheels
- Separate Metal Handrails
- Fast-Angle Wheel Sets
- Needle-Point Axles
- Sliding Car Doors
- 1:48 Scale Dimensions
- Unit Measures: 14 1/2" x 2 5/8" x 4 3/16"

SD70ACe Diesel Engine Heritage Sets



The Heritage Series marks the fifth time in Union Pacific company history that the railroad has painted locomotives in colors other than the traditional UP "Armour Yellow" paint scheme. Previously, locomotives were custom painted in 1991 to honor UP employees serving in the Persian Gulf War, in 1994 to call attention to the United Way Campaign, in 1996 for the Atlanta Games Olympic Torch Relay Train, and in 2002 for the Salt Lake City Games Olympic Torch Relay Train.

Each of our SD70ACe locomotives will capture its real life counterpart's appearance as accurately as possible. The Hi-Cube Box Car and Extended Vision Caboose each feature a matching paint scheme that complements the U.P. livery design found on the locomotives. An additional 6-car set of matching Hi-Cube Box Cars will also be produced for those fans interested in creating a long unit train. Beginning in January 2007, one set, every month, will be released making it easy to collect all seven schemes.

Like our regular SD70ACe releases, the Heritage locomotives are fully outfitted with Proto-Sound 2.0, operating smoke, locomotive speed control, and remotely operated Proto-Couplers™ that work in conventional or command mode. They are Proto-Scale 3-2™ 3-rail/2-rail convertible for ultimate operational flexibility.



Chicago NorthWestern - SD70ACe Diesel Heritage Set

20-2769-1 Hi-Rail Wheels \$499.95

Chicago NorthWestern - SD70ACe Diesel Locomotive w/ Proto-Sound® 2.0

20-2769-2 Scale Wheels \$449.95



Chicago NorthWestern - 6-Car 50' High Cube Box Car Set

20-90354 \$249.95



Denver Rio Grande Western - 6-Car 50' High Cube Box Car Set

20-90355 \$249.95



Denver Rio Grande Western - SD70ACe Diesel Heritage Set

20-2770-1 Hi-Rail Wheels \$499.95

SD70ACe Diesel Locomotive w/ Proto-Sound® 2.0

20-2770-2 Scale Wheels \$449.95

SD70ACe Diesel Engine Heritage Sets



Missouri Pacific - SD70ACe Diesel Heritage Set
20-2771-1 Hi-Rail Wheels \$499.95
Missouri Pacific - SD70ACe Diesel Locomotive
w/ Proto-Sound® 2.0
20-2771-2 Scale Wheels \$449.95



Missouri Pacific - 6-Car 50' High Cube Box Car Set
20-90356 \$249.95



Western Pacific - SD70ACe Diesel Heritage Set
20-2775-1 Hi-Rail Wheels \$499.95
Western Pacific - SD70ACe Diesel Locomotive
w/ Proto-Sound® 2.0
20-2775-2 Scale Wheels \$449.95



Western Pacific - 6-Car 50' High Cube Box Car Set
20-90360 \$249.95



M-K-T - 6-Car 50' High Cube Box Car Set
20-90357 \$249.95



M-K-T - SD70ACe Diesel Heritage Set
20-2772-1 Hi-Rail Wheels \$499.95
M-K-T - SD70ACe Diesel Locomotive w/ Proto-Sound® 2.0
20-2772-2 Scale Wheels \$449.95

Alco-GE-IR Box Cab Diesel

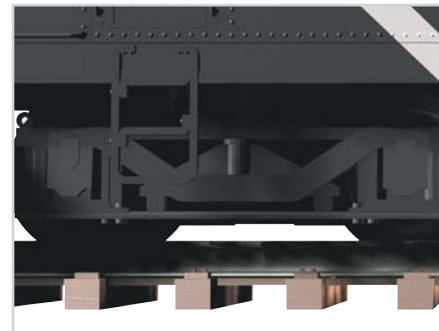

While the 1350 hp Electro Motive FT was The Diesel That Did It — retired the steam engine — this was The Diesel That Started It. The 300 hp Alco-GE-Ingersoll Rand boxcab was the first production Diesel-electric produced in North America. General Electric had been experimenting with internal combustion rail power for nearly two decades when, in the mid-1920s, it formed a partnership with Ingersoll Rand and Alco to manufacture Diesel-electrics. GE made the traction motors and generator, IR supplied the diesel motor, and Alco built the mechanical parts. In the summer of 1925, the Central Railroad of New Jersey bought the first boxcab demonstrator, and CNJ #1000 became the first production Diesel-electric owned by an American railroad. In December, the second engine in the production run became Baltimore & Ohio #1, and orders soon followed from the Chicago & North Western, Reading, and Erie. The Diesel revolution had quietly begun.

CNJ 1000 had a three-decade career switching the Bronx Terminal Yard, acquiring a Jersey Central Lines “Miss Liberty” paint job along the way. In 1957 it went to a well-earned retirement at the B&O Railroad Museum in Baltimore. B&O #1 had an equally long career in Manhattan and is preserved today at the Museum of Transportation in St. Louis. For 2007, M.T.H. offers the first-ever O scale model of this landmark locomotive.

NEW TOOLING!



Baltimore & Ohio - Alco-GE-IR Box Cab Diesel Engine
20-5591-1 Proto-Sound® 2.0 \$499.95

NEW TOOLING!



Jersey Central - Alco-GE-IR Box Cab Diesel Engine
20-5592-1 Proto-Sound® 2.0 \$499.95

NEW TOOLING!



Reading - Alco-GE-IR Box Cab Diesel Engine
20-5595-1 Proto-Sound® 2.0 \$499.95

NEW TOOLING!



Chicago NorthWestern - Alco-GE-IR Box Cab Diesel Engine
20-5593-1 Proto-Sound® 2.0 \$499.95

Features

- Directionally Controlled Headlights
- Intricately Detailed Die-Cast Body
- Metal Wheels, Axles and Gears
- Enhanced Detail Die-Cast Truck Sides & Pilots
- (2) Remotely Controlled Proto-Couplers™
- Authentic Paint Scheme
- Die-Cast Metal Chassis
- Precision Flywheel Equipped Motor
- Lighted Cab Interior
- Illuminated Number Boards
- Locomotive Speed Control
- (2) Engineer Cab Figures
- Proto-Sound® 2.0 With The Digital Command System Featuring Freight Yard Proto-Effects™
- Unit Measures: 9" x 2 1/2" x 3"
- Operates On O-31 Curves



NEW TOOLING!

Erie - GE I/R Box Cab Diesel Engine
20-5594-1 Proto-Sound® 2.0 \$499.95

EL-3A Jack Shaft Electric Engine

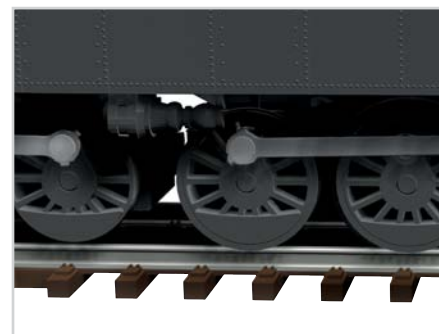
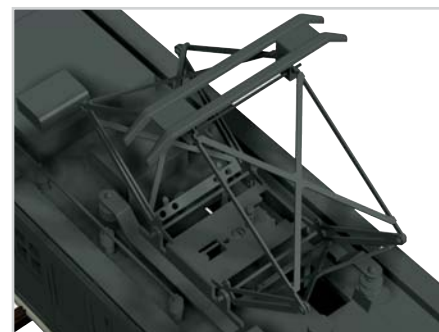

The Virginian Railway opened for business on July 1, 1909 with one purpose: to move coal from its West Virginia mines to its Chesapeake Bay coal docks. When the nearby C&O and N&W railroads demanded exorbitant rates to haul their coal, mine owner Henry Huttleston Rogers and his business associates had simply built their own railroad. The mountains on its West End division were the Virginian's biggest challenge. Despite the use of massive articulated engines — including a 2-8-8-4 Triplex — average speed on the West End was 7 mph, and the railroad could haul only half the daily production capacity of its mines.

Electrification was the answer. In the early 1920s, wires were strung over 132 miles of main line from the mines to Roanoke, Virginia. Twelve EL-3A electrics arrived on the property in 1925. Built by Alco and Westinghouse, the three-unit, 7,125 hp engines were the most powerful locomotives in the world at that time. Nicknamed "square heads," the EL-3As had two constant speeds, 14 and 28 mph; trains hustling down a mountain were said to be "twenty-eighting" it. A motor at each end turned a jackshaft and side rods to power the drivers, and the up-and-down motion of the rods gave the engines a distinctive side-to-side rocking gait. The squareheads instantly doubled the freight capacity of the West End division and became a sterling example of successful electrification. They served for over three decades until the last EL-3As were replaced by newer electrics in 1959. New for 2007, these massive mountain machines join the Premier line, ready to haul the heaviest trains on your layout.



NEW TOOLING! Virginian - EL-3A Jack Shaft Electric Set
20-5596-1 Proto-Sound® 2.0 \$1299.95



NEW TOOLING! Norfolk & Western - EL-3A Jack Shaft Electric Set
20-5599-1 Proto-Sound® 2.0 \$1299.95



NEW TOOLING! New Haven - EL-3A Jack Shaft Electric Set
20-5598-1 Proto-Sound® 2.0 \$1299.95

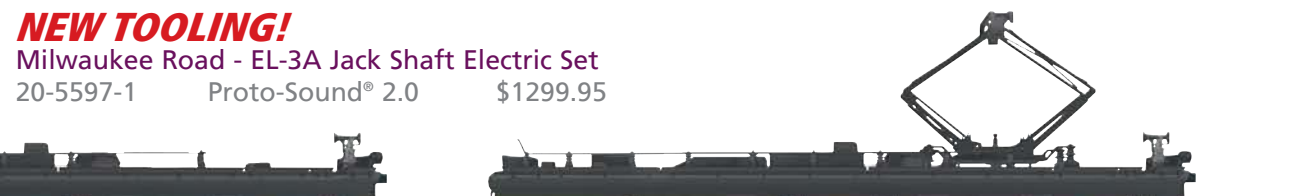

NEW TOOLING! Milwaukee Road - EL-3A Jack Shaft Electric Set
20-5597-1 Proto-Sound® 2.0 \$1299.95

Features

- Directionally Controlled Headlights
- Intricately Detailed Die-Cast Body
- Metal Wheels, Axles and Gears
- Remotely Controlled Operating Pantographs
- (2) Remotely Controlled Proto-Couplers™
- Authentic Paint Scheme
- Die-Cast Metal Chassis
- (2) Precision Flywheel Equipped

- Motors In Each Powered Unit
- Lighted Cab Interior
- Illuminated Number Boards
- Lighted Marker Lights
- Locomotive Speed Control
- (2) Engineer Cab Figures
- Proto-Sound® 2.0 With The Digital Command System Featuring: Freight Yard Proto-Effects™

- Each Unit Measures: 13 1/2" x 2 1/2" x 3 3/4"
- Operates On O-72 Curves

EQUIPPED WITH 4 MOTORS!



R40 Subway Set



In an attempt to bring a modern look to one of the world's oldest subway systems, the New York City Transit Authority hired Raymond Loewy to design a new order of cars in the late 1960s. One of the giants of twentieth century industrial design, Loewy was responsible for the look of Coke's vending machines, Air Force One's paint scheme, the Shell Oil logo, the Studebake Avanti, and countless projects for the Pennsylvania Railroad, including the GG1 and the 1938 Fleet of Modernism. The R40 subway, however, was one of his flops.

To give the new stainless steel cars an exciting look, Loewy's firm designed a molded fiberglass end cap with a 15-degree slant. Apparently no one thought to test the design before it went into production, and the new cars entered service on the F line's 6th Avenue Local on March 23, 1968. By early April, it became apparent that the slant ends presented a great danger to passengers walking from car to car, because they had to cross a large gap with nothing to hold onto. The Transit Authority's initial solution was to lock the end doors of all the R40 cars, which traveled in married pairs with a slant end at each end of the pair. Within months, the cars were retrofitted with elaborate pantograph gates on the slant ends, which effectively destroyed Loewy's rakish design but allowed passengers to wander from car to car in safety. The final 100 cars of the 400-car R40 order were then redesigned as R40M cars with a standard flat end. Built by St. Louis Car Company, the 60-foot R40s and R40Ms remain in service today on the BMT/IND lines, based at Coney Island in Brooklyn and Concourse Yard in the Bronx.

M.T.H. introduces full-scale models of these unique New York subway cars, featuring transit stop simulation available only from M.T.H. Designed specifically for our municipal transit cars, the unique Proto-Sound® 2.0 transit program features Station Stop Proto-Effects™, allowing you to program the train to stop automatically at designated station stops, even in Conventional Mode. When configured to run on automatic, the subway stops itself at locations you define and calls out accurate station names that you select in advance; the subway essentially runs itself. And when you program the set for an out-and-back route, it even reverses itself and heads back downtown when it reaches the end of the line - stopping along the way at each station to broadcast the name of the stop and the hustle and bustle of passengers coming and going.



Features

- Directionally Controlled Headlights
- Intricately Detailed ABS Bodies
- Metal Wheels and Axles
- Detailed Car Interiors
- Locomotive Speed Control
- Die-Cast Truck Sides
- (1) Remotely Controlled Proto-Coupler™
- Authentic Paint Scheme
- Operates on 0-42 Curves
- All Metal Wheels and Gears
- Illuminated Destination Boards
- (2) Precision Flywheel Equipped Motors In Power Unit
- Metal Chassis
- Lighted Interior
- Proto-Sound® 2.0 With the Digital Command System Featuring Passenger Station Stop Proto-Effects™
- Set Measures: 65" x 2 1/2" x 3"



R40 2-Car Subway Set Add-On

20-2717-3 Non-Powered \$199.95



R40 4-Car Subway Set

20-2717-1 Proto-Sound® 2.0 \$499.95

North Shore Electroliner

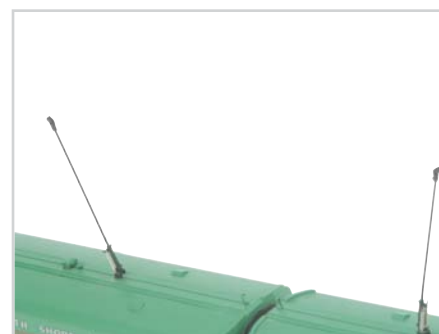

If there was ever a prototype for the Little Engine That Could, it was the North Shore's Electroliners. In 1939 interurban systems like the Chicago North Shore & Milwaukee were a dying breed. Once the latest word in intercity transportation, these fast, comfortable electric railways were one by one falling victim to the automobile and the Depression. But on November 15, 1939, Col. Albert A. Sprague, receiver for the bankrupt North Shore, petitioned the Chicago District Court of the United States for permission to buy two new trains to help save the railroad. Just a year earlier, Col. Sprague had convinced the North Shore's striking workers to return to work and take a pay cut that essentially paid for the new trains. Although they were only a small part of Col. Sprague's modernization program, the Electroliners became a symbol of hope and determination for both the North Shore's employees and the line-side communities that depended on the railroad.

Patterned in part on the pioneering Burlington Zephyr, the Electroliners were described by the Chicago Daily Times as the work of "a group of American mechanics

who made their professional pride and talent substitute for a wad of money." The two identical four-car trains were fast, smooth, luxurious, comfortable, and arguably the finest interurbans ever built. A tavern-lounge car offered food and beverage service. Quotes in the North Shore Line News reported employees' first impressions of the new trains: "You feel like you are hardly moving, they ride so easily...They decelerate from high speed as smooth as a feather floating down...The outside colors are a knockout but look at those interiors — there is nothing like them...Inside they are so roomy you wonder where the space comes from...The artists who did those murals in the cars knew what is needed in these times — there's a smile in every figure; something that puts you in a good humor."

The Electroliners entered regular service on Sunday, February 9, 1941, running five round trips daily between Chicago and Milwaukee, in hot competition with the Milwaukee Road's Hiawatha and the Chicago & North Western's 400. Because they reached their Chicago terminal on the elevated tracks of Chicago's Loop, the

Electroliners had curved sides, narrow at the bottom to fit the elevated's high platforms and wider at the waist to offer passengers more room — a design that the Chicago "L" would later adopt for its own cars. The Electroliners and the determination they symbolized bought the North Shore another 22 years of life after most other interurbans had vanished. When the North Shore closed down in 1963, the little trains — which together had run more than 6.7 million miles — moved on to the Philadelphia Suburban Transportation Company, also known as the Red Arrow Lines. Their trolley poles were removed, and they took power from the third-rail pickup shoes they had used on the Chicago "L". Repainted and renamed the Liberty Liners, the two trainsets served until 1979. Today you can visit them at the Illinois Railway Museum, which has restored its Electroliner to North Shore colors, or the Rockhill Trolley Museum.

Read a two-part Trains magazine article on the Electroliners by searching on the Electroliner's item number at www.mthtrains.com.



Red Arrow Lines - 4-Car Liberty Liner Set
20-2784-1 Proto-Sound® 2.0 \$599.95



North Shore Line - 4-Car Electroliner Set
20-2783-1 Proto-Sound® 2.0 \$599.95

Features

- Directionally Controlled Headlights
- Intricately Detailed ABS Bodies
- Metal Wheels and Axles
- Detailed Car Interiors
- Locomotive Speed Control
- Die-Cast Truck Sides
- Authentic Paint Scheme
- Operates on 0-42 Curves
- All Metal Wheels and Gears
- Set Equipped With (2) Precision Motors
- Metal Chassis
- Lighted Interior
- Authentic Electroliner horn and pneumatic gong sounds
- Proto-Sound® 2.0 With the Digital Command System Featuring Passenger Station Stop Proto-Effects™
- 4-Car Set Measures: 39" x 2 1/2" x 3"



Operating Reefer Cars



Budweiser - Operating Reefer Car
20-94125 \$99.95

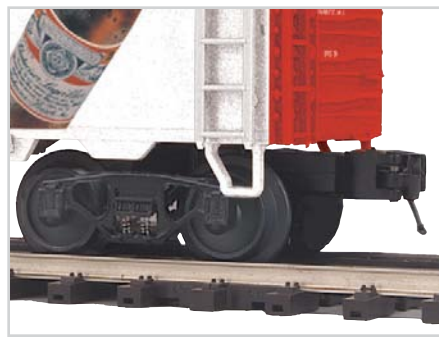

CHROME PLATED



Coors Light - Operating Reefer Car
20-94124 \$99.95

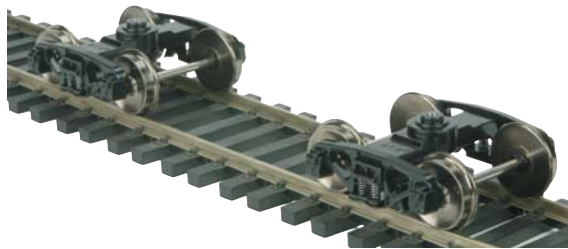

2-Rail Bettendorf Freight Car Two Truck Pack
20-89001 \$12.99



2-Rail Bettendorf Freight Car Two Truck Pack
20-89001 \$12.99



3-Rail Roller Bearing Freight Car Two Truck Pack
20-89004 \$12.99
3-Rail Bettendorf Freight Car Two Truck Pack
20-89003 \$12.99

"© 2006 Anheuser-Busch, Inc. All Rights Reserved."

© 2006 Molson Coors Global Properties, LLC. Coors trademarks are properties of Molson Coors Global Properties, LLC, used under license by M.T.H. Electric Trains Limited Edition Adult Collectible-This licensed product is intended for purchase and enjoyment by individuals of legal purchase age for alcohol beverages.

Features

- Metal Wheels and Axles
- Die-Cast 4-Wheel Trucks
- Operating Die-Cast Metal Couplers
- Colorful, Attractive Paint Schemes
- Decorative Brake Wheels
- Fast-Angle Wheel Sets
- Needle-Point Axles

- Operating Interior Lighting
- Intricately Detailed Durable ABS Body
- Auto Opening Door
- Operating Workman Pushes Out Load
- Simulated Dry-Ice "Smoke"
- Unit Measures: 11 5/8" x 2 3/4" x 3 9/16"
- Operates On O-31 Curves

Operating Log/Dump Cars



CSX - Operating Log Dump Car
20-98591 \$54.95



New Haven - Operating Log Dump Car
20-98592 \$54.95



Pittsburgh & Lake Erie - Operating Dump Car
20-98594 \$54.95



Duluth Missabe and Iron Range - Operating Dump Car
20-98593 \$54.95



Features

- Die-Cast Metal Body
- Metal Wheels and Axles
- Die-Cast 4-Wheel Trucks
- Operating Die-Cast Metal Couplers
- Colorful, Attractive Paint Schemes
- Fast-Angle Wheel Sets
- Needle-Point Axles

- Die-Cast Metal Body
- Operating Bay Rises Up On One Side
- Side Wall Drops Down To Release Load
- Operates With Any Operating Track Section
- Operates With Any Transformer
- Unit Measures: 12" x 2 5/8" x 2 11/16"
- Operates On O-27 Curves

40' Box Cars

55' All-Door Box Car



Seaboard - 40' Box Car
20-93352 \$44.95



Burlington Northern - 40' Box Car
20-93354 \$44.95



Harley-Davidson® - 40' Box Car
20-93349 \$49.95



Frisco - 40' Box Car
20-93353 \$44.95



B.C. Hydro Railway - 55' All-Door Box Car
20-93313 \$49.95



Canfor - 55' All-Door Box Car
20-93311 \$49.95

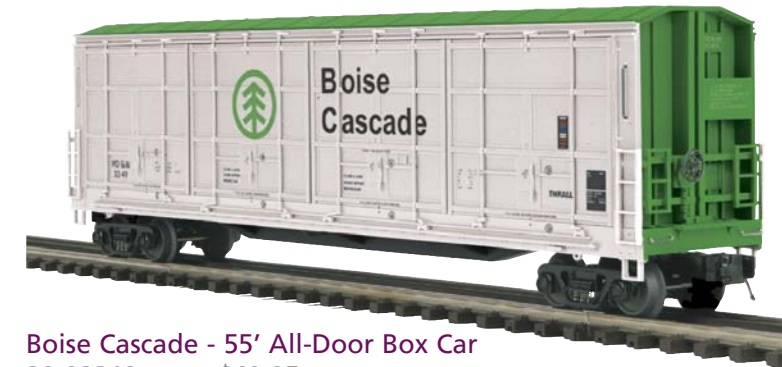

Boise Cascade - 55' All-Door Box Car
20-93312 \$49.95



Masonite Corporation - 55' All-Door Box Car
20-93310 \$49.95



Features

- Intricately Detailed Durable ABS Body
- Metal Wheels and Axles
- Die-Cast 4-Wheel Trucks
- Operating Die-Cast Metal Couplers
- Colorful, Attractive Paint Schemes
- Decorative Brake Wheels
- Separate Metal Handrails
- Fast-Angle Wheel Sets
- Needle-Point Axles
- Sliding Car Doors
- 1:48 Scale Dimensions
- Unit Measures: 11 5/8" x 2 5/8" x 3 3/4"
- Operates On O-31 Curves



© 2006 H-D, All Rights Reserved. Manufactured by M.T.H. Electric Trains under license from Harley-Davidson Motor Company.
© 2006 M.T.H. Electric Trains, 7020 Columbia Gateway Drive, Columbia, Maryland 21046



Features

- Intricately Detailed Durable ABS Body
- Metal Wheels and Axles
- Die-Cast 4-Wheel Trucks
- Operating Die-Cast Metal Couplers
- Colorful, Attractive Paint Schemes
- Decorative Brake Wheels
- Separate Metal Handrails
- Fast-Angle Wheel Sets
- Needle-Point Axles
- Sliding Car Doors
- 1:48 Scale Dimensions
- Unit Measures: 15 1/8" x 2 9/16" x 4 1/16"
- Operates On O-31 Curves

40' AAR Box Cars

50' High-Cube Box Cars



Missouri Pacific - 40' AAR Box Car
20-93357 \$44.95



Erie - 40' AAR Box Car
20-93356 \$44.95



Montana Rail Link - 50' High Cube Box Car
20-93359 \$49.95



York Rail - 50' High Cube Box Car
20-93362 \$49.95



SOO Line - 40' AAR Box Car
20-93358 \$44.95



Denver Rio Grande - 40' AAR Box Car
20-93355 \$44.95



Features

- Intricately Detailed Durable ABS Body
- Metal Wheels and Axles
- Die-Cast 4-Wheel Trucks
- Operating Die-Cast Metal Couplers
- Colorful, Attractive Paint Schemes
- Decorative Brake Wheels
- Separate Metal Handrails
- Fast-Angle Wheel Sets
- Needle-Point Axles
- Sliding Car Doors
- 1:48 Scale Dimensions
- Unit Measures: 11 1/2" x 2 5/8" x 3 3/4"
- Operates On O-31 Curves



Quebec Central - 50' High Cube Box Car
20-93361 \$49.95



Norfolk Southern - 50' High Cube Box Car
20-93360 \$49.95



Features

- Intricately Detailed Durable ABS Body
- Metal Wheels and Axles
- Die-Cast 4-Wheel Trucks
- Operating Die-Cast Metal Couplers
- Colorful, Attractive Paint Schemes
- Decorative Brake Wheels
- Separate Metal Handrails
- Fast-Angle Wheel Sets
- Needle-Point Axles
- Sliding Car Doors
- 1:48 Scale Dimensions
- Unit Measures: 14 1/2" x 2 5/8" x 4 3/16"
- Operates On O-31 Curves

40' Reefer Cars

40' Steel Sided Reefer Cars



Western Pacific - 40' Reefer Car
20-94140 \$49.95



Pacific Fruit Express - 40' Reefer Car
20-94138 \$49.95



Western Maryland - 40' Reefer Car
20-94139 \$49.95



Minneapolis & St. Louis - 40' Reefer Car
20-94141 \$49.95

Features

- Intricately Detailed Durable ABS Body
- Metal Wheels and Axles
- Die-Cast 4-Wheel Trucks
- Operating Die-Cast Metal Couplers
- Colorful, Attractive Paint Schemes
- Opening Doors
- Fast-Angle Wheel Sets
- Needle-Point Axles
- 1:48 Scale Dimensions
- Unit Measures: 11 5/8" x 2 3/4" x 3 9/16"
- Operates On O-42 Curves



Illinois Central - 40' Steel Sided Reefer Car
20-94131 \$49.95



Santa Fe - 40' Steel Sided Reefer Car
20-94194 \$49.95

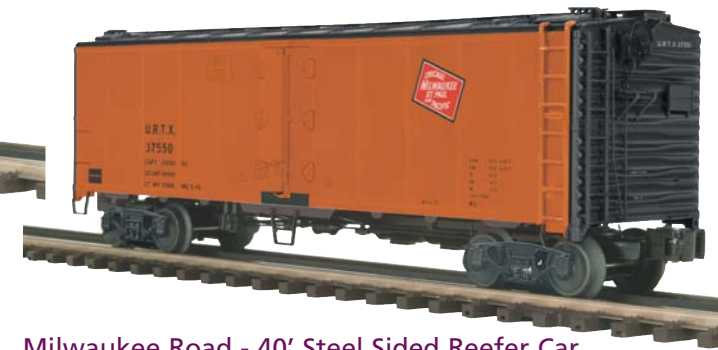

Milwaukee Road - 40' Steel Sided Reefer Car
20-94133 \$49.95

Features

- Intricately Detailed Durable ABS Body
- Metal Wheels and Axles
- Die-Cast 4-Wheel Trucks
- Operating Die-Cast Metal Couplers
- Colorful, Attractive Paint Schemes
- Decorative Brake Wheels
- Separate Metal Handrails
- Fast-Angle Wheel Sets
- Needle-Point Axles
- 1:48 Scale Dimensions
- Unit Measures: 11 3/4" x 2 9/16" x 3 1/2"
- Operates On O-31 Curves



Iowa Beef - 40' Steel Sided Reefer Car
20-94132 \$49.95



R50B Express Reefer Cars

60' Reefer Cars



Pennsylvania - R50B Express Reefer Car
20-94135 \$59.95



Chesapeake & Ohio - R50B Express Reefer Car
20-94137 \$59.95



Pennsylvania - R50B Express Reefer Car
20-94134 \$59.95



Railway Express Agency - R50B Express Reefer Car
20-94136 \$59.95

Features

- Intricately Detailed Durable ABS Body
- Metal Wheels and Axles
- Die-Cast 4-Wheel Trucks
- Operating Die-Cast Metal Couplers
- Colorful, Attractive Paint Schemes
- Opening Doors
- Fast-Angle Wheel Sets
- Needle-Point Axles
- 1:48 Scale Dimensions
- Unit Measures: 14 1/2" x 2 1/2" x 3 1/2"
- Operates On O-31 Curves



Great Northern - 60' Reefer Car
20-94130 \$54.95



Coors Light - 60' Reefer Car
20-94128 \$59.95

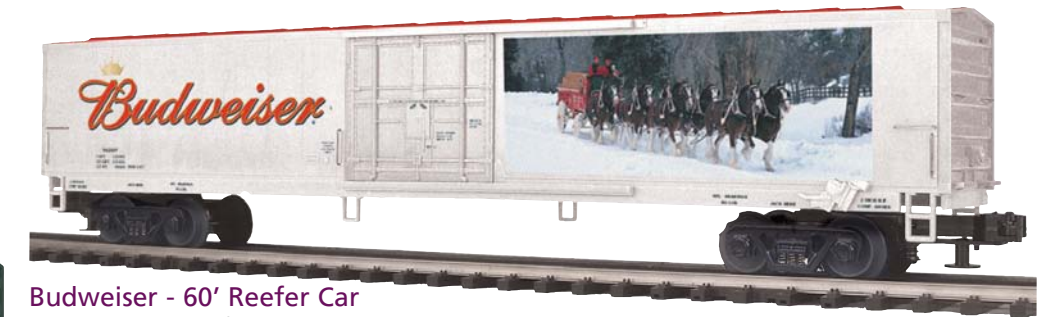

Budweiser - 60' Reefer Car
20-94127 \$59.95



Railway Express Agency - 60' Reefer Car
20-94129 \$54.95

Features

- Intricately Detailed Durable ABS Body
- Metal Wheels and Axles
- Die-Cast 4-Wheel Trucks
- Operating Die-Cast Metal Couplers
- Colorful, Attractive Paint Schemes
- Fast-Angle Wheel Sets
- Needle-Point Axles
- 1:48 Scale Dimensions
- Unit Measures: 16 1/2" x 2 1/2" x 3 1/2"
- Operates On O-42 Curves

"© 2006 Anheuser-Busch, Inc. All Rights Reserved."

© 2006 Molson Coors Global Properties, LLC. Coors trademarks are properties of Molson Coors Global Properties, LLC, used under license by M.T.H. Electric Trains Limited Edition Adult Collectible-This licensed product is intended for purchase and enjoyment by individuals of legal purchase age for alcohol beverages.



36' Woodsided Reefer Cars

Rapid Discharge Cars



Heinz - 36' Woodsided Reefer Car
20-94321 \$54.95



Erie Brewing Company - 36' Woodsided Reefer Car
20-94324 \$49.95



Wisconsin Central System - Rapid Discharge Car
20-97195 \$44.95



Florida East Coast - Rapid Discharge Car
20-97193 \$44.95



GATX - Rapid Discharge Car
20-97194 \$44.95



Conrail - Rapid Discharge Car
20-97192 \$44.95

- Features**
- Intricately Detailed Durable ABS Body
 - Metal Wheels and Axles
 - Die-Cast 4-Wheel Trucks
 - Operating Die-Cast Metal Couplers
 - Colorful, Attractive Paint Schemes
 - Separate Metal Handrails
 - Fast-Angle Wheel Sets
 - Needle-Point Axles
 - 1:48 Scale Dimensions
 - Unit Measures: 11 1/4" x 2 9/16" x 3 3/8"
 - Operates On O-31 Curves

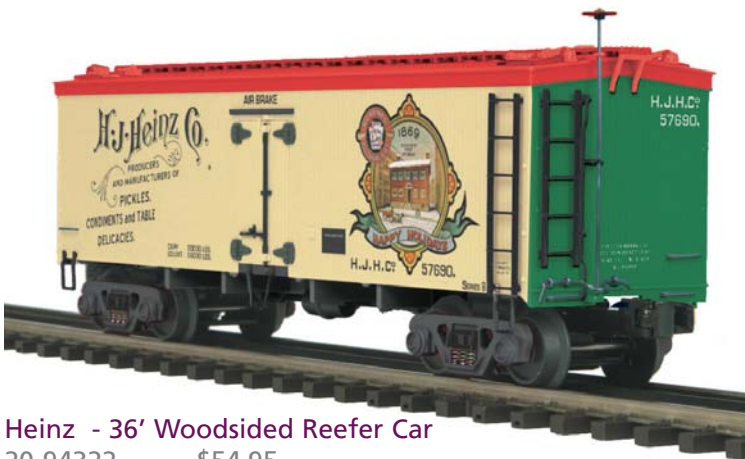

Heinz - 36' Woodsided Reefer Car
20-94322 \$54.95

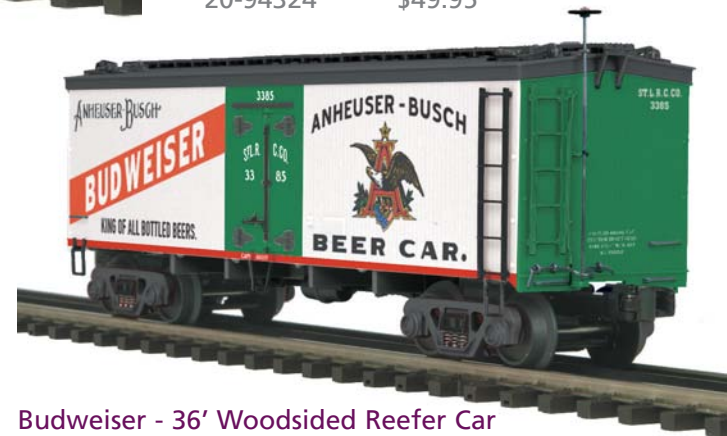

Budweiser - 36' Woodsided Reefer Car
20-94323 \$54.95



- Features**
- Intricately Detailed Durable ABS Body
 - Metal Wheels and Axles
 - Die-Cast 4-Wheel Trucks
 - Operating Die-Cast Metal Couplers
 - Colorful, Attractive Paint Schemes
 - Decorative Brake Wheels
 - Separate Metal Handrails
 - Fast-Angle Wheel Sets
 - Needle-Point Axles
 - 1:48 Scale Dimensions
 - Unit Measures: 10 3/4" x 2 1/38" x 3 1/4"
 - Operates On O-31 Curves

"© 2006 Anheuser-Busch, Inc. All Rights Reserved."

A licensed product of H.J. Heinz Company, L.P. © 2006

4-Bay Hopper Cars

100 Ton Hopper Cars



Bessemer & Lake Erie - 4-Bay Hopper Car
20-97622 \$44.95



Norfolk Southern - 4-Bay Hopper Car
20-97621 \$44.95



Louisville & Nashville - 4-Bay Hopper Car
20-97624 \$44.95



CSX - 4-Bay Hopper Car
20-97623 \$44.95



Canadian National - 100 Ton Hopper Car
20-97600 \$49.95



Saskatchewan - 100 Ton Hopper Car
20-97603 \$49.95



Canadian Wheat - 100 Ton Hopper Car
20-97601 \$49.95



Alberta - 100 Ton Hopper Car
20-97598 \$49.95

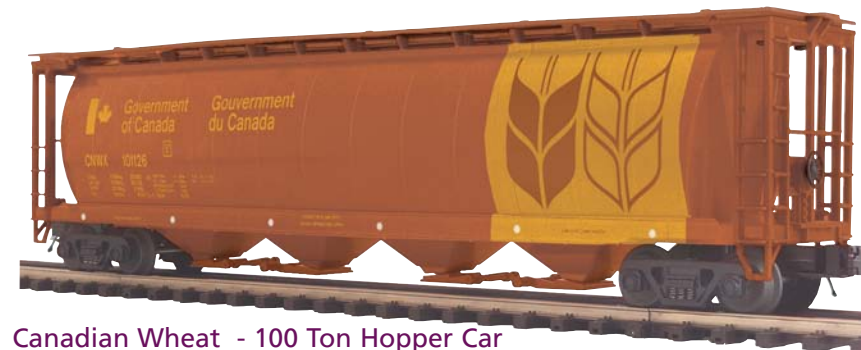

Canadian Wheat - 100 Ton Hopper Car
20-97602 \$49.95



Canada - 100 Ton Hopper Car
20-97599 \$49.95

Features

- Intricately Detailed Durable ABS Body
- Metal Wheels and Axles
- Die-Cast 4-Wheel Trucks
- Operating Die-Cast Metal Couplers
- Colorful, Attractive Paint Schemes
- Fast-Angle Wheel Sets
- Needle-Point Axles
- 1:48 Scale Dimensions
- Unit Measures: 13 1/4" x 2 5/8" x 3"
- Operates On O-31 Curves

Features

- Intricately Detailed Durable ABS Body
- Metal Wheels and Axles
- Die-Cast 4-Wheel Trucks
- Operating Die-Cast Metal Couplers
- Colorful, Attractive Paint Schemes
- Fast-Angle Wheel Sets
- Needle-Point Axles
- 1:48 Scale Dimensions
- Unit Measures: 15" x 2 11/16" x 3 3/4"
- Operates On O-31 Curves

**LOOK FOR SIX CAR SETS IN
PREMIER SET SECTION!**

See Page 163

2-Bay Centerflow Hopper Cars

3-Bay Centerflow Hopper Cars



Detroit & Toledo Shoreline - 2-Bay Centerflow Hopper
20-97614 \$44.95



BNSF - 2-Bay Centerflow Hopper
20-97613 \$44.95



Western Maryland - 2-Bay Centerflow Hopper
20-97616 \$44.95



Missouri & Pacific - 2-Bay Centerflow Hopper
20-97615 \$44.95



Features

- Intricately Detailed Durable ABS Body
- Metal Wheels and Axles
- Die-Cast 4-Wheel Trucks
- Operating Die-Cast Metal Couplers
- Colorful, Attractive Paint Schemes
- Fast-Angle Wheel Sets
- Needle-Point Axles
- 1:48 Scale Dimensions
- Unit Measures: 10 1/8" x 2 11/16" x 3 3/4"
- Operates On O-31 Curves



SOO Line - 3-Bay Centerflow Hopper
20-97617 \$49.95



Grasshopper - 3-Bay Centerflow Hopper
20-97618 \$49.95



Detroit, Toledo & Ironton - 3-Bay Centerflow Hopper
20-97619 \$49.95

Features

- Intricately Detailed Durable ABS Body
- Metal Wheels and Axles
- Die-Cast 4-Wheel Trucks
- Operating Die-Cast Metal Couplers
- Colorful, Attractive Paint Schemes
- Fast-Angle Wheel Sets
- Needle-Point Axles
- 1:48 Scale Dimensions
- Unit Measures: 13 7/8" x 2 11/16" x 3 7/8"
- Operates On O-31 Curves



Cargill - 3-Bay Centerflow Hopper
20-97620 \$49.95



2-Bay Fish Belly Hopper Cars

NEW TOOLING!



Pennsylvania - 2-Bay Fish Belly Hopper Car
20-97190 \$44.95

NEW TOOLING!



Norfolk & Western - 2-Bay Fish Belly Hopper Car
20-97189 \$44.95

NEW TOOLING!



Chesapeake & Ohio - 2-Bay Fish Belly Hopper Car
20-97188 \$44.95

NEW TOOLING!



Western Maryland - 2-Bay Fish Belly Hopper Car
20-97191 \$44.95

Features

- Intricately Detailed Durable ABS Body
- Metal Wheels and Axles
- Operating Interior Lighting
- Die-Cast 4-Wheel Trucks
- Colorful, Attractive Paint Schemes
- Operating Die-Cast Metal Couplers
- Fast-Angle Wheel Sets
- Needle-Point Axles
- 1:48 Scale Dimensions
- Unit Measures:
9 1/4" X 2 5/8" X 3"
- Operates On O-31 Curves



Ps-2CD High-Sided Hopper Car



Grand Trunk Western - Ps-2CD High-Sided Hopper Car
20-97197 \$49.95



Chicago NorthWestern - Ps-2CD High-Sided Hopper Car
20-97196 \$49.95



Santa Fe - Ps-2CD High-Sided Hopper Car
20-97198 \$49.95



Penn Central - Ps-2CD High-Sided Hopper Car
20-97199 \$49.95

Features

- Intricately Detailed Durable ABS Body
- Metal Wheels and Axles
- Die-Cast 4-Wheel Trucks
- Operating Die-Cast Metal Couplers
- Colorful, Attractive Paint Schemes
- Fast-Angle Wheel Sets
- Needle-Point Axles
- 1:48 Scale Dimensions
- Separate Metal Handrails
- Decorative Brake Wheels
- Unit Measures: 14" x 2 11/16" x 3 13/16"
- Operates On O-31 Curves



Tank Car

8000 Gallon Tank Car



Norfolk Southern - Tank Car
20-96160 \$49.95



British Columbia Railway - Tank Car
20-96159 \$49.95



New York Central - 8000 Gallon Tank Car
20-96158 \$44.95



Baltimore & Ohio - 8000 Gallon Tank Car
20-96155 \$44.95



Burlington Northern - Tank Car
20-96162 \$49.95



CSX - Tank Car
20-96161 \$49.95



Features

- Intricately Detailed Durable ABS Body
- Metal Wheels and Axles
- Die-Cast 4-Wheel Trucks
- Operating Die-Cast Metal Couplers
- Colorful, Attractive Paint Schemes
- Fast-Angle Wheel Sets
- Needle-Point Axles
- 1:48 Scale Dimensions
- Separate Metal Handrails
- Unit Measures: 12" x 2 3/4" x 4 3/16"
- Operates On O-27 Curves

Features

- Intricately Detailed Durable ABS Body
- Metal Wheels and Axles
- Die-Cast 4-Wheel Trucks
- Operating Die-Cast Metal Couplers
- Colorful, Attractive Paint Schemes
- Fast-Angle Wheel Sets
- Needle-Point Axles
- 1:48 Scale Dimensions
- Separate Metal Handrails
- Unit Measures: 9 1/16" x 2 3/4" x 3 7/8"
- Operates On O-27 Curves

Coil Cars



Norfolk Southern - Coil Car
20-98569 \$49.95



Bessemer & Lake Erie - Coil Car
20-98566 \$49.95



BNSF - Coil Car
20-98567 \$49.95



CSX - Coil Car
20-98568 \$49.95

Features

- Intricately Detailed Durable ABS Body
- Metal Wheels and Axles
- Die-Cast 4-Wheel Trucks
- (4) Individual Coil Spools
- Removeable Coil Cover
- Operating Die-Cast Metal Couplers
- Colorful, Attractive Paint Schemes
- Fast-Angle Wheel Sets
- Needle-Point Axles
- 1:48 Scale Dimensions
- Unit Measures: 13" x 2 1/2" x 3 3/4"
- Operates On O-31 Curves



Gondola Cars w/ LCL Containers



Baltimore & Ohio - Gondola Car w/LCL Cement Containers
20-98060 \$44.95



Norfolk & Western - Gondola Car w/LCL Cement Containers
20-98061 \$44.95



Reading - Gondola Car w/LCL Cement Containers
20-98062 \$44.95



Southern Pacific - Gondola Car w/LCL Cement Containers
20-98063 \$44.95

Features

- Intricately Detailed Durable ABS Body
- Metal Wheels and Axles
- Die-Cast 4-Wheel Trucks
- Operating Die-Cast Metal Couplers
- Colorful, Attractive Paint Schemes
- Fast-Angle Wheel Sets
- Needle-Point Axles
- 1:48 Scale Dimensions
- (5) Removeable LCL Containers
- Unit Measures: 14 5/8" x 2 5/8" x 3 15/16"
- Operates On O-31 Curves



Steel Sided Stock Cars

Center I-Beam Flat Cars w/ Lumber



Santa Fe - Steel Sided Stock Car
20-94525 \$44.95



New York Central - Steel Sided Stock Car
20-94524 \$44.95



Chicago NorthWestern - Steel Sided Stock Car
20-94523 \$44.95



Chesapeake & Ohio - Steel Sided Stock Car
20-94522 \$44.95

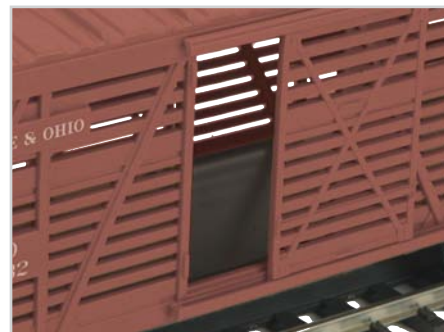

Features

- Intricately Detailed Durable ABS Body
- Metal Wheels and Axles
- Die-Cast 4-Wheel Trucks
- Operating Die-Cast Metal Couplers
- Colorful, Attractive Paint Schemes
- Decorative Brake Wheels
- Separate Metal Handrails
- Fast-Angle Wheel Sets
- Needle-Point Axles
- Sliding Car Doors
- Stamped Metal Floors
- 1:48 Scale Dimensions
- Unit Measures: 11 5/8" x 2 11/16" x 3 13/16"
- Operates On O-31 Curves



Canadian National - Center Beam Flat Car w/Lumber Load
20-98572 \$49.95



Ontario Northland - Center Beam Flat Car w/Lumber Load
20-98574 \$49.95



TTX - Center Beam Flat Car w/Lumber Load
20-98575 \$49.95

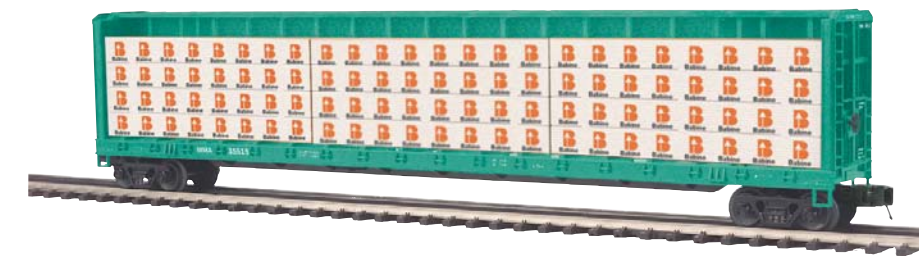

Montreal, Maine & Atlantic - Center Beam Flat Car w/Lumber Load
20-98573 \$49.95



Features

- Durable ABS Intricately Detailed Bodies
- Metal Wheels and Axles
- Die-Cast 4-Wheel Trucks
- Operating Die-Cast Metal Couplers
- Colorful, Attractive Paint Schemes
- Removeable Lumber Load
- Operates On O-31 Track
- Fast-Angle Wheel Sets
- Needle-Point Axles
- 1:48 Scale Dimensions
- Unit Measures: 20" x 2 3/8" x 4 3/8"
- Operates On O-42 Curves

Flat Cars w/ Load



Caterpillar® - Flat Car w/432E Backhoe
20-98565 \$59.95



Caterpillar® - Flat Car w/(2) CAT Haulers
20-98564 \$69.95



Caterpillar® - Flat Car w/ 48' Trailer
20-98460 \$59.95



Caterpillar® - Flat Car w/ 48' Trailer
20-98563 \$59.95



Caterpillar® - Flat Car w/ 48' Trailer
20-98485 \$59.95

Features

- Intricately Detailed Durable ABS Body
- Metal Wheels and Axles
- Die-Cast 4-Wheel Trucks
- Operating Die-Cast Metal Couplers
- Colorful, Attractive Paint Schemes
- Fast-Angle Wheel Sets
- Needle-Point Axles
- 1:48 Scale Dimensions
- (1) 48' Trailer or (2) Die-Cast Haulers
- Unit Measures: 14 1/2" x 2 1/2" x 4 1/2"
- Operates On O-31 Curves



© 2006 Caterpillar
Cat, Caterpillar, their respective logos, Caterpillar Yellow, other marks and corporate identity used herein are trademarks of Caterpillar and may not be used without permission. Third-party trademarks are the property of their respective owners.

Flat Cars w/ Load



TTX - 47' TTX Heavy Duty Flat Car w/SW-1500 Locomotive
20-98579 \$129.95



TTX - 47' TTX Heavy Duty Flat Car w/SW-1500 Locomotive
20-98578 \$129.95



TTX - Flat Car w/LoV Subway Car
20-98590 \$89.95



TTX - Flat Car w/LoV Subway Car
20-98589 \$89.95

Features

- Intricately Detailed Durable ABS Body
- Metal Wheels and Axles
- Die-Cast 4-Wheel Trucks
- Operating Die-Cast Metal Couplers
- Colorful, Attractive Paint Schemes
- Fast-Angle Wheel Sets
- Needle-Point Axles
- 1:48 Scale Dimensions
- 47' TTX Heavy Duty Flat Car w/SW-1500
Unit Measures: 16 1/2" x 2 11/16" x 2 1/8"
- Flat Car w/LoV Subway Car
Unit Measures: 14 5/8" x 2 3/4" x 1 11/16"
- Operates On O-42 Curves



60' Flat Car w/ Trash Containers

NEW TOOLING!



Union Pacific - Union Pacific - 60' Flat Car w/Trash Containers
20-98584 \$59.95

NEW TOOLING!



Canadian National - 60' Flat Car w/Trash Containers
20-98583 \$59.95

NEW TOOLING!



Burlington Northern - 60' Flat Car w/Trash Containers
20-98582 \$59.95

NEW TOOLING!



TTX - 60' Flat Car w/(2)M1A Abrams Tanks
20-98580 \$69.95

Features

- Intricately Detailed Durable ABS Body
- Metal Wheels and Axles
- Die-Cast 4-Wheel Trucks
- Operating Die-Cast Metal Couplers
- Colorful, Attractive Paint Schemes
- Fast-Angle Wheel Sets
- 1:48 Scale Dimensions
- Highly Detailed Tank & Container Loads
- Unit Measures: 14 1/2" x 2 1/2" x 4 1/2"
- Operates On O-42 Curves

Schnabel Flat Cars



CSX - Schnabel Flatcar
20-98576 \$119.95

Features

- Intricately Detailed Durable ABS Body
- Metal Wheels and Axles
- Die-Cast 4 or 6-Wheel Trucks
- Operating Die-Cast Metal Couplers
- Colorful, Attractive Paint Schemes
- Decorative Brake Wheels
- Separate Metal Handrails
- Fast-Angle Wheel Sets
- 1:48 Scale Dimensions
- Removable 1:43 Transformer Load
- Unit Measures: 26 1/2" x 3 3/16" x 4 7/8"
- Operates On O-72 Curves



Norfolk Southern - Schnabel Flatcar
20-98577 \$119.95

50' Flat Cars w/ Load



Union Pacific - Flat Car w/(2) Fishing Boats
20-98586 \$49.95



Pennsylvania - Flat Car w/(2) Rescue Boats
20-98587 \$49.95



Canadian National - Flat Car w/Camper Trailer
20-98588 \$49.95



Alaska - Flat Car w/(2) Campers
20-98585 \$49.95

Features

- Intricately Detailed Durable ABS Body
- Metal Wheels and Axles
- Die-Cast 4-Wheel Trucks
- Operating Die-Cast Metal Couplers
- Colorful, Attractive Paint Schemes
- Fast-Angle Wheel Sets
- 1:48 Scale Dimensions
- Unit Measures: 14 1/2" x 2 1/2" x 4 1/2"
- Operates On O-31 Curves

Features

- Intricately Detailed Durable ABS Body
- Metal Wheels and Axles
- Operating Interior Lighting
- Die-Cast 4-Wheel Trucks
- Operating Die-Cast Metal Coupler
- Colorful, Attractive Paint Schemes
- Decorative Brake Wheels
- Separate Metal Handrails
- Fast-Angle Wheel Sets
- Needle-Point Axles
- 1:48 Scale Dimensions
- Operating Headlight
- Moveable Plow Wings
- Unit Measures: 12 3/4" x 2 11/16" x 4 1/4"
- Operates On O-31 Curves

Jordan Spreaders



Pennsylvania - Jordan Spreader
20-98570 \$69.95



Canadian Pacific - Jordan Spreader
20-98571 \$69.95

Extended Vision Caboose



Reading - Extended Vision Caboose
20-91231 \$59.95

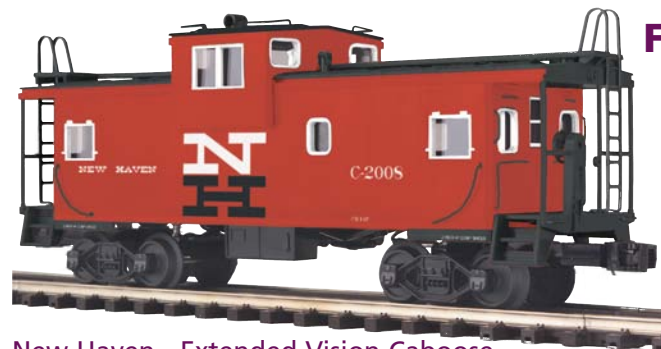

New Haven - Extended Vision Caboose
20-91230 \$59.95



Southern - Extended Vision Caboose
20-91232 \$59.95



Western Maryland - Extended Vision Caboose
20-91233 \$59.95

N-8 Caboose



Pennsylvania - N-8 Caboose
20-91235 \$59.95



Pennsylvania - N-8 Caboose
20-91234 \$59.95

Features

- Intricately Detailed Durable ABS Body
- Detailed Car Interior
- Brakeman Figure
- Metal Wheels and Axles
- Die-Cast 4-Wheel Trucks
- Operating Die-Cast Metal Couplers
- Colorful, Attractive Paint Schemes
- Fast-Angle Wheel Sets
- Needle-Point Axles
- 1:48 Scale Dimensions
- Caboose Interiors With Overhead Lighting
- Separate Metal Handrails
- Decorative Brake Wheels
- 1:48 Scale Dimensions
- Extended Vision Caboose:
Unit Measures: 10 3/4" x 2 3/4" x 4"
- N-8 Caboose:
Unit Measures: 9 5/8" x 2 1/2" x 3 15/16"
- Operates On O-31 Curves

Bay Window Caboose



Lehigh Valley - Bay Window Caboose
20-91229 \$59.95



Baltimore & Ohio - Bay Window Caboose
20-91226 \$59.95



Canadian National - Bay Window Caboose
20-91227 \$59.95



Conrail - Bay Window Caboose
20-91228 \$59.95

Features

- Intricately Detailed Durable ABS Body
- Metal Wheels and Axles
- Die-Cast 4-Wheel Trucks
- Operating Die-Cast Metal Couplers
- Colorful, Attractive Paint Schemes
- Fast-Angle Wheel Sets
- Needle-Point Axles
- 1:48 Scale Dimensions
- Caboose Interiors With Overhead Lighting
- Caboose Brakeman Figure
- Separate Metal Handrails
- Decorative Brake Wheels
- 1:48 Scale Dimensions
- Unit Measures: 10 7/8" x 2 15/16" x 3 13/16"
- Operates On O-31 Curves



Freight Sets

Twin Stack Container Sets

NEW TOOLING!



CSX - 3-Car Twin Stack Container Set
20-90366 \$219.95



CSX - 5-Car Twin Stack Container Set
20-90365 \$349.95



CSX - 2-Car Twin Stack Container Set
20-90367 \$159.95



Southern Pacific - 2-Car Twin Stack Container Set
20-90373 \$159.95



BNSF - 2-Car Twin Stack Container Set
20-90364 \$159.95



Southern Pacific - 5-Car Twin Stack Container Set
20-90371 \$349.95



BNSF - 5-Car Twin Stack Container Set
20-90362 \$349.95



Southern Pacific - 3-Car Twin Stack Container Set
20-90372 \$219.95



BNSF - 3-Car Twin Stack Container Set
20-90363 \$219.95

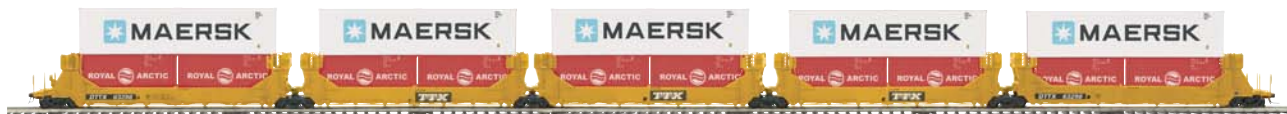

TTX - 5-Car Twin Stack Container Set
20-90368 \$349.95

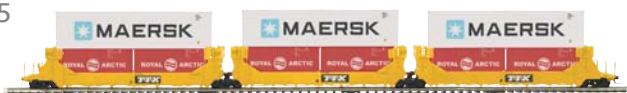

TTX - 3-Car Twin Stack Container Set
20-90369 \$219.95



TTX - 2-Car Twin Stack Container Set
20-90370 \$159.95



Features

- Intricately Detailed Durable ABS Body
- Metal Wheels and Axles
- Die-Cast 4-Wheel Trucks
- Operating Die-Cast Metal Couplers
- Colorful, Attractive Paint Schemes
- Fast-Angle Wheel Sets
- Needle-Point Axles
- 1:48 Scale Dimensions
- 5-car Set: End Unit= 14 3/4" X 2 3/4" X 3"
Middle Unit= 13 5/16" X 2 3/4" X 3"
- 2-Car Set: Each Car Measures: 14 3/4" X 2 3/4" X 3"
- 3-Car Set: Each Car Measures: 13 5/16" X 2 3/4" X 3"

6-Car 36' Woodsided Reefer Set



Altoona 36 Lager - 6-Car 36' Woodsided Reefer Set
20-90346 (#'s 360246, 360244, 360248, 360260, 360264, 360266) \$249.95
20-90347 (#'s 360241, 360262, 360269, 360268, 360245, 360247) \$249.95



Fort Pitt Brewing - 6-Car 36' Woodsided Reefer Set
20-90348 (#'s 362040, 362044, 362048, 362052, 362056, 362053) \$249.95
20-90349 (#'s 362043, 362050, 362059, 362046, 362058, 362041) \$249.95



Budweiser - 6-Car 36' Woodsided Reefer Set
20-90350 (#'s 3370, 3372, 3384, 3396, 3376, 3378) \$269.95
20-90351 (#'s 3375, 3373, 3388, 3382, 3390, 3391) \$269.95

© 2006 Anheuser-Busch, Inc. All Rights Reserved.



Erie Brewing Company - 6-Car 36' Woodsided Reefer Set
20-90352 (#'s 29080, 29072, 29078, 29064, 29076, 29065) \$249.95
20-90353 (#'s 29088, 29060, 29079, 29083, 29075, 29082) \$249.95

Features

- Metal Wheels and Axles
- Die-Cast 4-Wheel Trucks
- Operating Die-Cast Metal Couplers
- Colorful, Attractive Paint Schemes
- Fast-Angle Wheel Sets
- Needle-Point Axles
- Separate Metal Handrails
- Decorative Brake Wheels
- Intricately Detailed Durable ABS Bodies
- Opening Car Doors
- 1:48 Scale Dimensions
- Each Car Individually Numbered
- Operates On O-31 Curves
- Each Car Measures: 10 3/4" x 2 3/8" x 3 1/4"



Freight Sets

6-Car Fish Belly Hopper Car Set



Western Maryland - 6-Car Fish Belly Hopper Car Set

20-90344 (#'s 10789, 10780, 10782, 10795, 10793, 10794)
20-90345 (#'s 10726, 10740, 10722, 10749, 10735, 10734)

\$249.95 **NEW TOOLING!**
\$249.95



Pennsylvania - 6-Car Fish Belly Hopper Car Set

20-90342 (#'s 713948, 713942, 713950, 713957, 713953, 713944)
20-90343 (#'s 713952, 713943, 713956, 713959, 713954, 713941)

\$249.95 **NEW TOOLING!**
\$249.95



Chesapeake & Ohio - 6-Car Fish Belly Hopper Car Set

20-90338 (#'s 300444, 300440, 300443, 300445, 300448, 300432)
20-90339 (#'s 300402, 300416, 300430, 300412, 300414, 300409)

\$249.95 **NEW TOOLING!**
\$249.95



Norfolk & Western - 6-Car Fish Belly Hopper Car Set

20-90340 (#'s 22004, 22006, 22012, 22026, 22034, 22046)
20-90341 (#'s 22008, 22019, 22000, 22048, 22024, 22028)

\$249.95 **NEW TOOLING!**
\$249.95

Features

- Intricately Detailed Durable ABS Body
- Metal Wheels and Axles
- Die-Cast 4-Wheel Trucks
- Operating Die-Cast Metal Couplers
- Colorful, Attractive Paint Schemes
- Fast-Angle Wheel Sets
- Needle-Point Axles
- 1:48 Scale Dimensions
- Each Car Measures: 9 1/4" X 2 5/8" X 3"
- Operates on 0-31 Curves



6-Car 100 Ton Hopper Car Set



Saskatchewan - 6-Car 100 Ton Hopper Car Set

20-90337 (#'s 397000, 397020, 397046, 397024, 397018, 397036) \$249.95



Alberta - 6-Car 100 Ton Hopper Car Set

20-90332 (#'s 396008, 396012, 396015, 396014, 396003, 396020) \$249.95



Canada - 6-Car 100 Ton Hopper Car Set

20-90333 (#'s 109055, 109046, 109059, 109074, 109060, 109042) \$249.95



Canadian National - 6-Car 100 Ton Hopper Car Set

20-90334 (#'s 379386, 379381, 379350, 379346, 379346, 379353) \$249.95



Canadian Wheat - 6-Car 100 Ton Hopper Car Set

20-90335 (#'s 107620, 107625, 107653, 107638, 107627, 107604) \$249.95



Canadian Wheat - 6-Car 100 Ton Hopper Car Set

20-90336 (#'s 101185, 101123, 101145, 101172, 101160, 101129) \$249.95

Features

- Intricately Detailed Durable ABS Body
- Metal Wheels and Axles
- Die-Cast 4-Wheel Trucks
- Operating Die-Cast Metal Couplers
- Colorful, Attractive Paint Schemes
- Fast-Angle Wheel Sets
- Needle-Point Axles
- 1:48 Scale Dimensions

Streamlined Passenger Cars

Illinois Central

It is hard to match the excitement and beauty of a long, sleek passenger train speeding down the rails. M.T.H.'s Premier Line scale streamlined passenger cars and sets will bring exactly the right, realistic look to your passenger consists.

No other manufacturer matches the quality and value found inside an M.T.H. Premier Line passenger car. Using an intricately detailed, yet durable ABS body atop smooth rolling die-cast metal trucks results in a lightweight car that won't bog down a locomotive struggling to pull heavy aluminum passenger cars. What's more, each Premier Line passenger car features detailed car interiors and overhead lighting for a realistic and authentic appearance.



Illinois Central - 70' ABS Full Length Vista Dome Passenger Car
20-67110 \$79.95



Illinois Central - 2-Car 70' ABS Baggage/Coach Passenger Set
20-69110 \$159.95



Illinois Central - 2-Car 70' ABS Slpr/Diner Passenger Set (Smooth)
20-66110 \$159.95

Southern

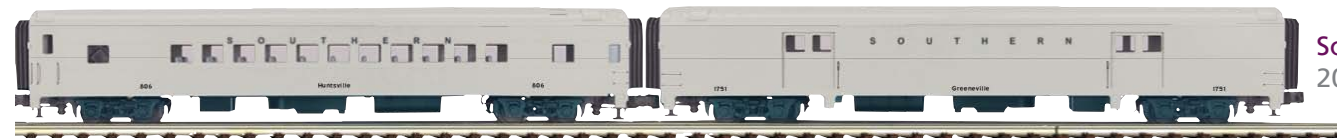

Southern - 2-Car 70' ABS Baggage/Coach Passenger Set
20-69107 \$159.95



Southern - 5-Car 70' ABS Passenger Set (Ribbed)
20-65107 \$399.95



Southern - 70' ABS RPO Passenger Car (Ribbed)
20-68107 \$69.95

Features

- Durable ABS Intricately Detailed Bodies
- Metal Wheels and Axles
- Overhead Interior Lighting
- Die-Cast 4-Wheel Trucks
- Operating Die-Cast Metal Couplers
- Colorful, Attractive Paint Schemes
- End-of-Car Diaphragms
- Separate Metal Handrails
- Fast-Angle Wheel Sets
- Needle-Point Axles
- Detailed Car Interiors
- 10 Passenger Figures In Each Coach Car
- 1:48 Scale Dimensions
- Detailed Car Undercarriage
- Sliding Baggage Car Doors
- 5-Car Sets Feature: (1) Baggage, (2) Coaches, (1) Vista Dome, (1) Observation
- Unit Measures: 95" x 2 7/16" x 3 1/2"
- Operates On O-42 Curves

Missouri Pacific



Missouri Pacific - 2-Car 70' ABS Slpr/Diner Passenger Set (Smooth)
20-66108 \$159.95



Missouri Pacific - 2-Car 70' ABS Baggage/Coach Passenger Set
20-69108 \$159.95



Missouri Pacific - 70' ABS RPO Passenger Car (Smooth)
20-68108 \$69.95

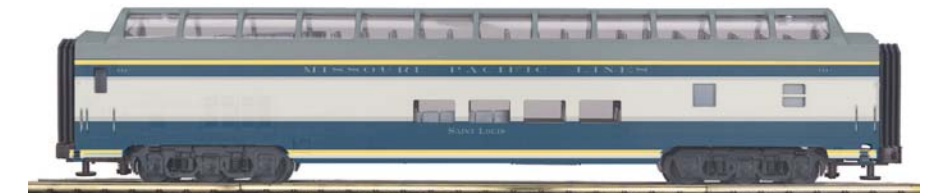

Missouri Pacific - 70' ABS Full Length Vista Dome Passenger Car
20-67108 \$79.95



Missouri Pacific - 5-Car 70' ABS Passenger Set (Smooth)
20-65108 \$399.95



Southern - 70' ABS Full Length Vista Dome Passenger Car
20-67107 \$79.95



Southern - 2-Car 70' ABS Slpr/Diner Passenger Set (Ribbed)
20-66107 \$159.95

Streamlined Passenger Cars

Atlantic Coast Line



Atlantic Coast Line - 2-Car 70' ABS Baggage/Coach Passenger Set
20-69106 \$159.95



Atlantic Coast Line - 70' ABS RPO Passenger Car (Ribbed)
20-68106 \$69.95



Atlantic Coast Line - 5-Car 70' ABS Passenger Set (Ribbed)
20-65106 \$399.95



Atlantic Coast Line - 70' ABS Full Length Vista Dome Passenger Car
20-67106 \$79.95



Atlantic Coast Line - 2-Car 70' ABS Slpr/Diner Passenger Set (Ribbed)
20-66106 \$159.95

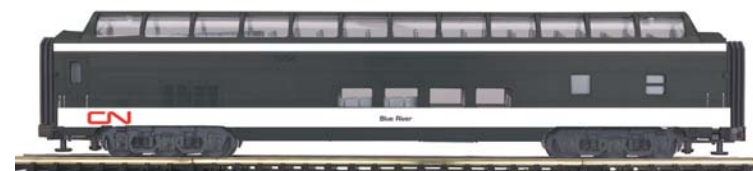

Canadian National - 70' ABS Full Length Vista Dome Passenger Car
20-67109 \$79.95



Canadian National - 2-Car 70' ABS Baggage/Coach Passenger Set
20-69109 \$159.95



Canadian National - 5-Car 70' ABS Passenger Set (Smooth)
20-65109 \$399.95



Canadian National - 2-Car 70' ABS Slpr/Diner Passenger Set (Smooth)
20-66109 \$159.95

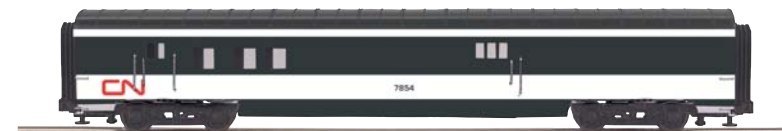

Canadian National - 70' ABS RPO Passenger Car (Smooth)
20-68109 \$69.95



Union Pacific - 70' ABS RPO Passenger Car (Smooth)
20-6853 \$69.95



Pennsylvania - 70' ABS RPO Passenger Car (Smooth)
20-60002 \$69.95



Pennsylvania - 70' ABS Passenger Car (Smooth)
20-60001 \$69.95



Union Pacific - 70' ABS Full Length Vista Dome Passenger Car
20-68048 \$79.95



Southern Pacific - 70' ABS RPO Passenger Car (Smooth)
20-68082 \$69.95



Denver Rio Grande - 70' ABS RPO Passenger Car (Smooth)
20-68093 \$69.95



New Haven - 70' ABS RPO Passenger Car (Smooth)
20-68078 \$69.95



New York Central - 70' ABS RPO Passenger Car (Smooth)
20-68094 \$69.95



Madison Passenger Cars

Canadian National



Canadian National - 2-Car 70' Madison Comb/Din Passenger Set
20-4185 \$159.95



Canadian National - 2-Car 70' Madison Baggage/Coach Passenger Set
20-4485 \$159.95



Canadian National - 70' Madison RPO Passenger Car
20-4285 \$79.95



Chesapeake & Ohio - 70' Madison RPO Passenger Car
20-4284 \$79.95



Chesapeake & Ohio - 2-Car 70' Madison Comb/Din Passenger Set
20-4184 \$159.95



Chesapeake & Ohio - 2-Car 70' Madison Baggage/Coach Passenger Set
20-4484 \$159.95

Features

- Durable ABS Intricately Detailed Bodies
- Metal Wheels and Axles
- Overhead Interior Lighting
- Die-Cast 4-Wheel Trucks
- 10 Passenger Figures In Each Coach Car
- Operating Die-Cast Metal Couplers
- Colorful, Attractive Paint Schemes
- End-of-Car Diaphragms
- Separate Metal Handrails
- Fast-Angle Wheel Sets
- Needle-Point Axles
- Detailed Car Interiors
- 1:48 Scale Dimensions
- Detailed Car Undercarriage
- Sliding Baggage Car Doors
- 2-Car Sets Feature (1) Combine, (1) Diner
- Unit Measures: 38" x 2 7/16" x 3 1/2"
- Operates On O-42 Curves

Chesapeake & Ohio



POWER IS EVERYTHING AND M.T.H. HAS YOU COVERED WITH FOUR DIFFERENT TRANSFORMER OPTIONS ALL PRICED AT ABOUT \$1.00 PER WATT.

If you want to power up gradually, you can purchase the RailKing 50-watt Z-500™, 75-watt Z-750™ or 100 watt Z-1000™ transformers as your power needs change. Featuring a U.L. approved design, each model utilizes a separate controller which contains bell, horn & direction buttons that can control any manufacturer's locomotives & sound systems including Proto-Sound® equipped steam, diesel & electric locomotives.

If you want to max out your power potential, the 400-watt Z-4000® is the most powerful transformer to ever receive the UL-listing for the model railroading hobby. The Z-4000 has two separate throttles to let you power two different tracks and it features two fixed power outputs you can use for operating accessories. The built-in amp and volt meters allow you to monitor your layout with total confidence.

REMOTE CONTROL

Today's model railroaders can immerse themselves in their model railroading experience with walk-around remote control options that put you right where the action is. As you compile more trains, more track, & begin more advanced operations, you might find yourself looking for a way to move around the room while you run your train. The sophisticated, but easy to use remote control systems from M.T.H. are some of your best solutions.

The Z-4000 Remote Control System - designed to work with the 400-watt Z-4000 transformer, this remote can control up to 3 Z-4000s at a time, for a total of 6 loops of track, all from one handheld. The LED screen makes it easy to keep an eye on your track voltage.

The DCS Remote Control System - the ultimate in control, the DCS system gives you individual control of each Proto-Sound 2.0 engine on your layout & gives you access to literally hundreds of new & exciting features & engine settings. Add the optional AIU & you can control each accessory & switch from the same remote control.

Whatever option you choose, M.T.H. puts you in charge of your empire.

Transformers

Z-750 Transformer
40-750 \$79.95

Z-1000 Transformer
40-1000 \$99.95

Z-4000 Transformer
40-4000 \$429.95

100-Watt Accessory Power Supply
40-1000A \$79.95

TIU/Barrel Jack Adapter Cable
50-1017 \$9.95

DCS users who don't need a conventional transformer and controller can use this 100 watt power supply for small and moderate sized layouts. Featuring a U.L. approved design & separate 14v AC Accessory Port, its robust design will provide years of service. Use the optional TIU/Barrel Jack adapter to make connecting it to the DCS Track Interface Unit quick and easy.

Z-4000 TRANSFORMER



Z-4000 Transformer
40-4000 \$429.95

400 WATTS!
The Most Powerful U.L. Listed Transformer!

FEATURES

- U.L. Listed to U.S. & Canadian Standards
- Pure Sine Wave Power Signal
- (2) 20 Volt Variable Track Outputs
- (1) 14 Volt Fixed Output
- (1) 10 Volt Fixed Output
- Internal Cooling Fan
- On/Off Power Switch
- Power and Overload Indicator Lights
- Compatible As A Power Source For All O Gauge and Standard Gauge AC-Powered Locomotives & Accessories
- Circuit Breaker Protection For Each Output
- Voltage LED Displays
- Amperage LED Displays
- Unit Measures: 8 3/4" x 14 3/4" x 1 1/8"

Accessories



Harley-Davidson® - #193 Industrial Water Tower
30-90213 \$54.95



Harley-Davidson® - Lighted Billboard
30-90212 \$29.95



Ted's Tires - Single Story Corner Store
30-90216 \$49.95 **LIGHTED!**



Cosmo Family Pizzeria - Single Story Opposite Corner Store
30-90217 \$49.95 **LIGHTED!**



NEW!

Track Cleaning Block
40-1099 \$17.99



Over & Under Tunnel
40-1070 \$59.95
TRAIN AND TRACK NOT INCLUDED



Cream & Green - RailKing Hell Gate Bridge
30-90219 \$249.95



Red & Gray - RailKing Hell Gate Bridge
30-9020 \$249.95



Isaly's Dairy - Single Story Corner Store
30-90215 \$49.95 **LIGHTED!**



Main Street Hardware - Single Story Opposite Corner Store
30-90218 \$49.95 **SIGN LIGHTS UP!**



Barn Building
30-9072 \$29.95



Greyhound - Bus Station
30-9040 \$129.95

HARLEY-DAVIDSON OFFICIAL LICENSED PRODUCT
© 2006 H-D, All Rights Reserved. Manufactured by M.T.H. Electric Trains under license from Harley-Davidson Motor Company.
© 2006 M.T.H. Electric Trains, 7020 Columbia Gateway Drive, Columbia, Maryland 21046

Accessories



Caterpillar® - Rental Store
30-90127 \$59.95



40' Container Set (3)
20-95064 \$34.95



NEW!
Trash Container (2)
30-50037 \$29.95



Elevated Gate Tower
30-9097 \$24.95

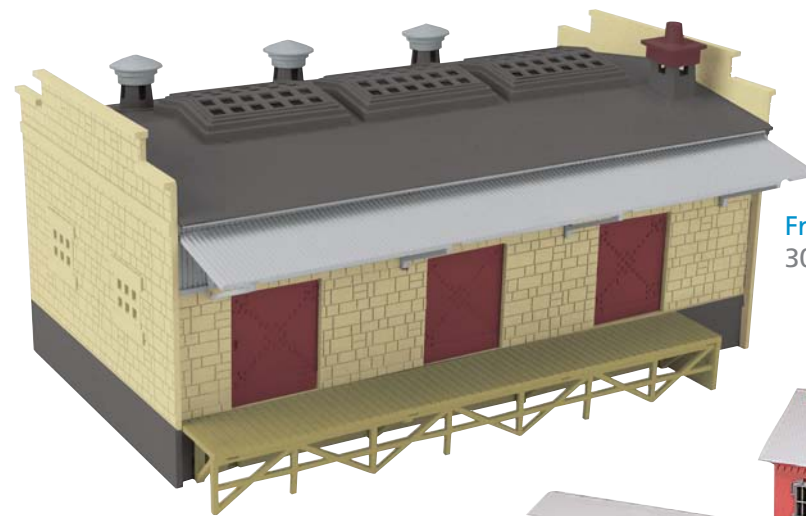

Freight Transfer Warehouse
30-9098 \$79.95

Fire Co. 219 - Operating Firehouse
30-9159 \$149.95



20' Container Set (3)
20-95063 \$29.95

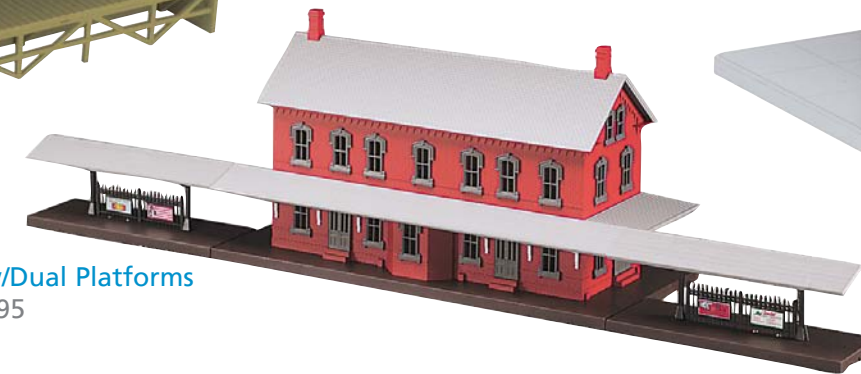

Passenger Station w/Dual Platforms
30-9014 \$79.95



Railtown - Country Passenger Station
30-9087 \$49.95

Operating Transfer Dock
30-9110 \$179.95



Pittsburgh Steelers - Passenger Station Platform
30-90214 \$29.95



McDonalds® - Operating McDonalds
30-9114 \$179.95



Dewey, Cheetum & How -
3-Story City Building w/Fire Escape & Blinking Sign
30-90154 \$59.95



©2006, NFL Enterprises LLC. NFL and the NFL Shield design are registered trademarks of the National Football League. The team names, logos and uniform designs are registered trademarks of the teams indicated.



© 2006 Caterpillar Cat, Caterpillar, their respective logos, Caterpillar Yellow, other marks and corporate identity used herein are trademarks of Caterpillar and may not be used without permission. Third-party trademarks are the property of their respective owners.



See More Accessories in the
**2006 Ready To Run Sets and
Accessories Catalog**

Join The Club

There are SIX different types of memberships, based on the style of model railroading that most interests you.

RAILKING MEMBERSHIP



30-73235 2007 MTHRRC Wooden Tank Car - 19th Century
RailKing Membership is \$50.00



PREMIER MEMBERSHIP



20-97200 2007 Waddell Coal 2-Bay Fish Belly Hopper
Premier Membership is \$50.00



ONE-GAUGE MEMBERSHIP



70-75020 2007 Norfolk & Western 4-Bay Hopper
One-Gauge Membership is \$100.00



TINPLATE STD. GAUGE 200 SERIES MEMBERSHIP



10-2223 2007 MTHRRC 200 Series Reefer Car
Tinplate 200 Series Membership is \$120.00



TINPLATE O GAUGE 2800 SERIES MEMBERSHIP



10-8069 2007 MTHRRC 2800 Series O Gauge Tank Car
Tinplate 2800 Series Membership is \$80.00



BASIC CLUB MEMBERSHIP

60-1000 - The Basic Club Membership does not include a club car
Basic Membership is \$25.00



AS A MEMBER OF THE M.T.H. RAILROADERS CLUB YOU'LL RECEIVE:

Limited-Edition Club Car



Each year we produce beautifully decorated cars exclusively for our Club members. Members automatically receive the car that matches their Club membership (RailKing®, Premier, Tinplate Traditions™ or One Gauge) & have the option to collect the other Club cars as well.

The CrossingGate™ Club Magazine



You will receive our full color Club magazines, jam-packed with product news, ideas from other members, rail history, & step-by-step articles explaining how M.T.H. technology can bring your railroad to life.

1st Class Mailing of M.T.H. Catalogs

Club Members get all of our catalogs earlier than all our other mailing list members via First-Class mailings, so they can order from their local train store before the best items are sold out.



RailWare™ Software Upgrade Kits



Use your computer to design track layouts, search the database of all M.T.H. products, look at our past catalogs, listen to Proto-Sound® 2.0 train effects, & much more. This CD retails for \$79.95, but is yours FREE as a Club member.

Club Card & Lapel Pin

Show the world your membership in this elite group of model railroaders with your high-quality embossed membership card & beautiful enamel lapel pin.



Proto-Sound® 2.0 Upgrade Kits

Club members can save an additional 15% on these kits by visiting the MTHRRC web page.

Club Web Site

Visit WWW.MTHTRAINS.COM & type in your member number to gain access to the Club web site. Here you can exchange messages with other Club members, keep up with the latest news, & even build your own homepage.

CARRY ON THE M.T.H. TRADITION WITH MEMORABILIA AND COLLECTIBLES

MTH Promotional DVD

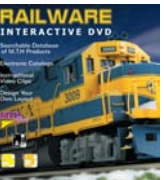

This interactive DVD is packed full of sights & sounds guaranteed to make you rethink how far the hobby of model railroading has come. You'll learn about some of the most innovative products ever produced & marvel at the sophistication of a product line unmatched by other model train manufacturers.

Previous Year Club Cars



MTHRRC members can still obtain earlier produced MTHRRC cars by visiting the MTHRRC pages on the website. Only MTHRRC members can get these cars!

A Toy Train Story



This comprehensive book is a must for collectors & other lovers of toy trains. 350 pages & 1900 color photos, hard cover. Add this book to your membership for only \$25.00 (50% off the \$49.95 cover price)!

GET THE MOST FROM MODEL RAILROADING

JOIN ONLINE! IT'S EASY - JUST GO TO WWW.MTHTRAINS.COM

There are over 1,100 M.T.H. Authorized Retailers in North America ready to serve your model railroading needs. Of these, a select few qualify for inclusion in M.T.H.'s Mega Station program. So just what is a Mega Station?

Simply put, M.T.H. Authorized Mega Stations are your best bet for finding the widest selection of M.T.H. products in stock, when you want them. Mega Station retailers also meet our DCS Demo Center qualifications so you'll find expert assistance in seeing M.T.H. products in action whenever you visit a Mega Station retailer.

Each of our Mega Station dealers has the option of qualifying for one or more categories covering our RailKing O Gauge, Premier Line O Scale, Tinplate Traditions and RailKing One Gauge product lines.

The list to the right includes our current RailKing and Premier O Gauge Mega Station accounts. Of course, if your favorite M.T.H. Authorized Retailer isn't listed, they can still order any of our current offerings. To find a local M.T.H. Authorized Retailer, visit our Web site and click on the Dealer Locator link.

ARIZONA
ARIZONA TRAIN DEPOT
Mesa
Phone: (480) 833-9486
www.arizonatraindepot.com

CALIFORNIA
WESTERN DEPOT
Yuba City
Phone: (530) 673-6776
www.westerndepot.com

DELAWARE
JUST TRAINS
Newark
Phone: (888) 453-9742
www.justtrains.com

FLORIDA
READY TO ROLL
Miami
Phone: (305) 688-8868
www.readytorolltrains.com

ROUNDHOUSE SOUTH
Port Orange
Phone: (386) 304-7002
www.roundhousesouth.com

ILLINOIS
BERWYN'S TOY TRAINS
Berwyn
Phone: (708) 484-4384
www.berwynstoytrains.com

IOWA
CABOOSE STOP HOBBIES
Cedar Falls
Phone: (800) 642-7012
www.caboosetophobbies.com

MARYLAND
CATOCTIN MTN. TRAINS & HOBBIES
Thurmont
Phone: (301) 694-8331
www.cmtrains.com

ENGINE HOUSE HOBBIES
Gaithersburg
Phone: (301) 590-0816
www.enginehousehobbies.biz

SIDETRACK HOBBIES
Leonardtown
Phone: (301) 475-5381
www.sidetrackhobbies.com

MASSACHUSETTS
NORTHEAST TRAINS
Peabody
Phone: (978) 532-1615
www.netrains.com

MICHIGAN
WILD BILL'S TRAINS & TOYS
Clinton Township
Phone: (586) 792-0530
www.wildbillstrains.com

NEVADA
RENO RAILS
Reno
Phone: (775) 337-6669
www.renorails.com

NEW JERSEY
THE HOBBY SHOP
Aberdeen
Phone: (732) 583-0505
www.hobbyshopnj.com

NEW YORK
NASSAU HOBBY CENTER, INC
Freeport
Phone: (516) 378-9594
www.nassauhobby.com

TRAIN WORLD
Brooklyn
Phone: (718) 436-7072
www.trainworld.com

TRAIN LAND
Lynbrook
Phone: (516) 599-7080
www.trainworld.com

SCAG'S ELECTRIC TRAINS
Staten Island
Phone: (718) 727-7373
www.e-zcatch.com

OHIO
DIXIE UNION STATION
Mason
Phone: (513) 459-0460
www.dixieunionstation.com

DUNHAM'S TOY TRAINS
London
Phone: (740) 852-0899

GLEN'S TRAINS SHOP
Akron
Phone: (330) 253-6527
www.glensatrainshop.com

PENNSYLVANIA
AMERICAN HOBBY CENTER
Aliquippa
724-378-3930
www.americanhobby.com

BRADY'S TRAIN OUTLET
Greensburg
724-838-8448
www.bradystrainoutlet.com

BUSSINGER TRAINS
Ambler
Phone: (215) 628-2366
www.icdc.com/~btrains

CHOO CHOO BARN
Strasburg
Phone: (717) 687-0464
www.etrainshop.com

IMPERIAL TRAIN COMPANY
Imperial
Phone: (724) 695-7552
www.imperialtrainco.com

JIM'S TRAIN SHOP
Homer City
Phone: (724) 479-2026
www.jimstrains.com

NICHOLAS SMITH TRAINS
Broomall
Phone: (610) 353-8585
www.nstrains.com

VALLEY FARM MARKET
Weedville
Phone: (814) 787-8911

RHODE ISLAND
B & F HOBBIES
Wakefield
Phone: (401) 782-6400

VIRGINIA
DAVIS HOBBY SUPPLIES
Portsmouth
757-397-1983
www.davishobby.com

WASHINGTON
EASTSIDE TRAINS
Kirkland
Phone: (425) 828-4098
www.eastsidetrains.com

WEST VIRGINIA
PATRICK'S TRAINS
Wheeling
Phone: (304) 232-0714
www.patstrains.com

HOME | ABOUT US | OUR TECHNOLOGY | NEWS | DEALERS | BUSINESS OPPORTUNITIES | REGIONAL LINKS | CONTACT US | MY MTH

1 Product Search: [CLICK HERE](#)

4 Shopping
4 Catalogs
4 Shows
4 Club Info
5 Service
4 Shipping
4 Video
2 Product Locator

Proto-Scale 3-2™ Diesels Begin Shipping
SD70m First of 3 Coming This Fall

6

[CLICK HERE TO LEARN MORE](#)

Uncataloged Proto-Scale 3-2™ Feature Included On SD70m and Upcoming Premier Line Diesel Releases

Coors Light Silver Bullet Coming In 2007 Volume 1 Catalog

[CLICK HERE For more details!](#)

[CLICK HERE For More Details](#)

7

Click: Below to Learn More about MTH...

[RAILKING](#) [REAL TRAX](#) [SCALETRAX](#) [MTH ELECTRIC TRAINS](#) [DCS DIGITAL COMMAND SYSTEM](#)

8 HOW DOES IT WORK?
Misplaced an instruction manual or just want to know how a product works? Use Advanced Search to look up the item and view its instruction manual.

Premier Line Erie Built Diesel Locomotives Arrive

Premier GG-1 Electric Engine

Not all products depicted in this catalog are production models. In some cases, the items pictured may be models in HO scale, O scale, or another scale that have been altered digitally.

Each item's graphic features and content are subject to change after publication. All product features may be verified on their retail packages.

M.T.H. Electric Trains is in no way affiliated with any of the railroads featured in this catalog.

©2007, M.T.H. Electric Trains, 7020 Columbia Gateway Drive, Columbia Maryland 21046-1532 www.mthtrains.com • 410-381-2580

MTH Trademarks: M.T.H. Electric Trains®, M.T.H.®, MTH Railroaders Club™, CrossingGate™, Ives®, Loco-Sound™, Proto-Sound™ 2.0, Proto-Speed Control™, Proto-Doppler™, Proto-Dispatch™, Proto-Cast™, ProtoSmoke™, Proto-Coupler™, Proto-Effects™, RailKing®, Rugged Rails®, RailKing One-Gauge™, RailTown™, Tinplate Traditions™, ScaleTrax™, RealTrax®, Z-500™, Z-750™, Z-4000®, Z-1000™, Z-4000 Remote Commander™, DCS™ and the MTH Numbering System and all others indicated throughout this catalog. DCS™ Simply The Best Way To Run A Railroad™

M.T.H.'s DCS Digital Command System has received U.S. Patent No. 6,457,681. M.T.H.'s Proto-Sound™ 2.0 system has received U.S. Patent No's 6,457,681 B1 (sound system), 6,457,681 B1 (Proto-Speed Control™), 6,604,641(Proto-Coupler™), 6,280,278 (Proto-Smoke™).

M.T.H.'s RealTrax® has received U.S. Patent No. 6,019,289. M.T.H.'s Z-4000® Transformer has received U.S. Patent No's. 6,281,606 & 6,624,537. Some images used in this publication © 2004 www.clipart.com

Lionel is a registered Trademark of Lionel Trains L.L.C.

TMCC®, TrainMaster®, CAB-1® Remote Controller, and Lionel® are all registered trademarks owned by Lionel L.L.C. All Rights Reserved.

© 2006 Caterpillar

Cat, Caterpillar, their respective logos, Caterpillar Yellow, other marks and corporate identity used herein are trademarks of Caterpillar and may not be used without permission. Third-party trademarks are the property of their respective owners.

John Deere is a registered trademark of Deere & Company.

RealTrax® layouts created with RR-Track™ which is a registered trademark of R&S Enterprises.

Major League Baseball trademarks and copyrights are used with permission of Major League Baseball Properties, Inc. MLB.com MTH Trains/MLBP 2006

©2006, NFL Enterprises LLC. NFL and the NFL Shield design are registered trademarks of the National Football League. The team names, logos and uniform designs are registered trademarks of the teams indicated.

Popsicle, Klondike, Good Humor are registered trademarks of Good Humor-Breyers. All Rights Reserved.

© 2006 H-D, All Rights Reserved. Manufactured by M.T.H. Electric Trains under license from Harley-Davidson Motor Company.
© 2006 M.T.H. Electric Trains, 7020 Columbia Gateway Drive, Columbia, Maryland 21046

"© 2006 Anheuser-Busch, Inc. All Rights Reserved."

Produced by M.T.H. Electric Trains Under License from Ohio State University

Rudolph the Red-Nosed Reindeer © and © The Rudolph Company, L.P. "Rudolph the Red-Nosed Reindeer" animated program © Classic Media, Inc. All Rights Reserved.

Greyhound is a registered trademark of the Greyhound Lines Inc.

A licensed product of H.J. Heinz Company, L.P. © 2006

© 2006 Molson Coors Global Properties, LLC. Coors trademarks are properties of Molson Coors Global Properties, LLC, used under license by M.T.H. Electric Trains Limited Edition Adult Collectible-This licensed product is intended for purchase and enjoyment by individuals of legal purchase age for alcohol beverages.

GOT QUESTIONS?

WWW.MTHTRAINS.COM HAS ANSWERS

We don't think we're exaggerating when we say M.T.H. has the most useful train manufacturer's site on the Internet. Here's just a sample of the answers you can find online.

1 WHAT'S THE LATEST INFO ON ...?
Use Advanced Search to find the latest info on new products before they're delivered - sound sets, cab numbers, feature and paint scheme updates, and other information that arrived after the catalog was published.

DID YOU EVER MAKE?
Use Advanced Search to search through nearly all of the 10,000 items we've made in the past 26 years, for your favorite road name, engine, or type of rolling stock.

2 DOES ANY DEALER STILL HAVE ...?
Locate hard-to-find items with our Product Locator, which searches the inventories of M.T.H. dealers across the country.

3 WHEN IS IT COMING?
Our online Shipping schedule is updated frequently to let you know what's coming soon to your hobby shop.

4 ARE YOU GOING TO MAKE?
View the last several M.T.H. Catalogs online. Or click on Video to see M.T.H. products in action.

5 How can I fix...?
The Service area of our site allows you to email a question to our factory technicians or find which of our 150+ local service centers is closest to you.

WHAT REPAIR PART DO I NEED?
Use Advanced Search to find exploded diagrams and parts lists for M.T.H. locomotives and accessories, and then order the parts online or by phone.

6 WHAT'S NEW?
New arrivals and other news are posted frequently on our home page. To get the news as it happens, sign up for our free weekly electronic newsletter, with information on new M.T.H. products, industry news, and sneak peeks at upcoming specials!

7 HOW CAN I LEARN MORE ABOUT DCS?
Follow the link to the protosound2.com Web site for DCS and Proto-Sound 2.0 information - and a list of Authorized DCS Demo Centers where you can try DCS hands-on.

HOW CAN I UPDATE MY DCS SYSTEM OR CHANGE A SOUND SET?

Only M.T.H. allows you to update your control system or change an engine's sound set right over the Internet. Follow the link to the protosound2.com Web site for DCS and Proto-Sound 2.0 downloads.

